



List Price Book
Effective January 1, 2023
Updated March 14, 2025

evolve systems



ISO 14001:2004 Registered
CGSB #006b



level™
the BIFMA sustainability standard
SCS-SCF0245-4
SCS-SCF0245-4

PROTECTING THE ENVIRONMENT FOR FUTURE GENERATIONS

Our environmental success story began with the challenge to create an office system that would meet today's business requirements while maintaining a firm commitment to save and protect the environment.

Sustainability became a part of the creative focus and development of Evolve that incorporates the latest technology and design features to provide excellent performance at a competitive price.

As government and industry environment ratings such as LEEDS & Greenguard become more prevalent, Evolve offers designers and architects functional, attractive, and economical office designs that meet these standards.

Evolve is a leader in reducing waste in the manufacturing of its products as well as utilizing recycled materials wherever possible. We make extensive use of recycled plastic and wood waste from other Global factories.

Evolve is committed to the continuous improvement of our environmental systems, the prevention of pollution, and to comply with both the spirit and the letter of all relevant environmental legislation.

Evolve Panels are 100% recyclable at the end of their lifespan. Nothing from an Evolve Panel needs to end up in a landfill.

PRODUCT INFORMATION

Evolve offers fabrics that are made from 100% recycled polyester, which means less waste going to landfills. These fabrics also reduced the demand for petroleum products, and decrease the environmental impacts of processing those petroleum products into polyester.

Evolve has developed a Panel interior made from 100% recycled wood and polypropylene. Through innovative design and technology, Evolve utilizes waste that would have normally been sent to landfill.

Evolve Panels are insulated with Roxul, a mineral wood insulation made from slag, an inert steel by-product, and basalt rock. Roxul is a high density product that provides maximum sound absorption to reduce noise in the work environment. Roxul insulation is fire resistant, water repellent and will not support the growth of fungi or mildew.

Evolve's epoxy powder coating process involves no liquids and is solvent free. It contains no harmful VOC's or lead. Up to 99% of over sprayed powdered is reclaimed, mixed with virgin powder and reused.



REFERENCES

| | |
|--|---------|
| Features, Benefits & General Information | 4-5 |
| Coding an Order | 6-8 |
| Textiles & Finishes | 320-324 |
| Panel COM Form | 325 |
| Panel Fabric Specification Sheet | 326 |
| Panel Fabric Sample..... | 328 |
| Appendix | 329 |
| Terms & Conditions..... | 330-331 |

PANELS

| | |
|-------------------------------------|---------|
| Panels – Technical Information..... | 10 |
| Panel – Types | 11-19 |
| Panel – Configurations..... | 20-21 |
| Graphic Panels | 22-26 |
| Monolithic | 27-31 |
| Segmented | 33-38 |
| Partly Glazed | 39-48 |
| Fully Glazed | 49-52 |
| Reception | 53-54 |
| Pass-thru Sliding door..... | 55-56 |
| Slatwall | 57-63 |
| Write Board..... | 64-65 |
| Laminate..... | 66-69 |
| Airflow..... | 70-70 |
| Metal Skin..... | 73-76 |
| Open | 77-82 |
| No Raceway | 83-95 |
| Gallery..... | 96-109 |
| 1” Laminate..... | 110-111 |
| Double Inline Connector..... | 112-113 |
| Door..... | 114-116 |
| Acoustic Grid..... | 117-119 |

EXTENSION MODULES

| | |
|---|---------|
| Extension Modules – Technical Information | 120 |
| Extension Modules – Types | 120 |
| Fabric..... | 121 |
| Tempered Glass..... | 122 |
| Reception Panel | 123 |
| Write Board..... | 124-125 |
| Laminate..... | 126-127 |
| Airflow..... | 128 |
| Open | 129 |
| Bridge Panel | 130-132 |
| Bridge Module..... | 133-138 |
| Privacy Glass | 139-148 |

| | |
|----------------------|---------|
| Felt Divider | 149-152 |
| Ceiling Filler | 153-155 |
| Privacy Panels | 156-172 |

PANELS - CONNECTORS

| | |
|-------------------------------------|---------|
| Panels – Technical Information..... | 175 |
| Inline Connector..... | 176-178 |
| End-of-Run..... | 179 |
| Two-Way Post | 180-183 |
| Three-Way Post..... | 184-188 |
| Four-Way Post..... | 189-192 |
| One Way Post..... | 193-194 |
| Inline Two-Way Post | 195-196 |
| 60 Degree..... | 197-199 |
| 45 Degree..... | 199-200 |
| Upmount End of Run | 200-201 |
| Extension | 202-205 |
| Trims..... | 206-209 |

ELECTRICAL

| | |
|--|---------|
| Electrical – Technical Information | 214 |
| Electrical – Wire Schematic | 212 |
| Electrical – Configurations..... | 213-214 |
| Power Distribution Housing..... | 215 |
| Cables..... | 216 |
| Power Entry..... | 219-218 |
| Post Extension..... | 218-220 |
| Task Lights..... | 220 |
| LED Lights | 220-222 |
| Accessories | 222-225 |

WORKSURFACES

| | |
|---|---------|
| Worksurfaces – Technical Information..... | 227 |
| Worksurfaces – Configuration | 228 |
| Worksurfaces – Grain Direction | 229 |
| Straight Worksurface..... | 231-232 |
| Curvilinear Worksurface | 233 |
| Corner Worksurface | 234-238 |
| “L” Worksurface..... | 239 |
| Transition Worksurface..... | 239 |
| Hatchet Worksurfaces | 240 |
| “D” Worksurface..... | 240 |
| “P” Top | 240 |
| Straight Wedge Worksurfaces | 241 |
| Piano Top..... | 242 |
| Quarter Round Panel Worksurface | 243 |
| Radius Worksurface..... | 244 |

| | |
|--------------------------------|---------|
| Transaction Worksurfaces | 244-247 |
| Height Adjustable | 248-251 |
| Accessories | 252-258 |

FREESTANDING DESKING

| | |
|--|---------|
| Freestanding Worksurface with Corner Legs .. | 261-262 |
|--|---------|

STORAGE

| | |
|---------------------------------------|---------|
| Storage – Technical Information | 265-267 |
| Overhead Storage | 268-286 |
| Pedestals..... | 277-282 |
| Cube Storage..... | 283-287 |
| Lateral Files..... | 288-295 |
| Storage Cabinet | 296 |
| Accessories | 297-298 |
| Storage Towers | 299-302 |
| Credenza..... | 303 |
| Key Alike Form | 304 |

ACCESSORIES

| | |
|----------------------------------|---------|
| Tack Board..... | 307 |
| White Marker Board | 308 |
| Load Bars..... | 308 |
| Rail Accessories..... | 311-313 |
| Keyboard Supports | 314 |
| Mouse Supports | 315 |
| Keyboard Combination Chart | 316 |
| Monitor Arms | 315-318 |
| Laptop Support..... | 319 |
| Desktop Document Holder | 329 |
| Touch-up Paint Kit | 320 |

PANELS

- NOTE: Panels consist of module frames, module interiors and a variety of skins.

Panel Information

- All metal components are painted with environmentally friendly epoxy powder.
- Raceway Interiors are coated with recycled epoxy powder.
- The entire Evolve Panel and the processes used to manufacture it are designed to save and protect the environment. Evolve panels are made from recycled materials and are 100% recyclable.
- Panels conform to CGSB and ANSI/BIFMA Standards
- The quality and performance level of these panels have been tested to equal or exceed the requirements of the U.S. Government.
- Classified as Acoustic, these panels meet the acoustical requirements of the U.S. Government with the following ratings:
 - .65 NRC
 - 23 STC
- Panel has a steel frame and is 2 7/8" thick. Corner posts create a panel creep of 3 1/4".
- Leveling Glides extend 2 1/2" high. (Carpet grippers are available, contact Evolve Customer Support).

Panel Options

- Standard, Beltline and Light* Segmented Panels are available in the following heights: 30", 42", 54" and 66".
- Standard, Beltline and Light* Monolithic Panels are available in the following heights: 42", 48", 54" and 66"
 - * Light panels do not contain a base raceway, therefore the listed heights consider the 6" open space that would have contained a raceway.
- Standard and Light Panel widths come in (8) sizes: 18", 24", 30", 36", 42", 48" 54" and 60"
- Beltline Panel widths come in (7) sizes: 24", 30", 36", 42", 48", 54" and 60". The 6" Power Belt Module is metal with knockouts on both sides.
- Beltline Panel with Chimney widths come in (2) sizes: 36" and 42".

Panel Skin Options

- Acoustic Fabric (Tackable), Glazed, Open, Laminate, Whiteboard, Metal, Air Flow, Slat

Panel Extension Modules

- Attaches to the top of Standard, Beltline or Light panels.
- Offered in 6", 12", 18" and 24" heights
- Can be stacked in an excess of 14'-0". (Contact the Evolve Specification Department regarding additional support required.)

Extension Module Options

- Fabric, Glazed, Open, Laminate, Whiteboard and Airflow. Laminate and Whiteboard available in single and double sided.

Panel Reconfiguration

- Panels can be modified on site by replacing fabric modules with Glazed, Open, Laminate, Whiteboard or Air Flow at any time after the initial installation*.
- All panel types existing on site can have their height altered by replacing the vertical liners (on each side of the panel) and adding or subtracting modules* as required.
- Fabric can be replaced easily; using pre-cut segments of fabric, a drawstring (C-Jex) is sewn in around the edges. Then a rubber spline is used to 'screen' the fabric in place.
- Panels can be removed from the workstation, without having to remove an overhead or worksurface.
- Corner connectors can be converted from 2-way to 3-way, etc., by attaching an in-line connector with one screw.
- The Power Belt Module for the Beltline Panels cannot be relocated.

*Contact Evolve Customer Support for information on field installed modules (they are available in heights of 6", 12" and 24")

VOICE/DATA AND ELECTRICAL POWER

- NOTE: Panels and Electric components are CSA/UL approved. Tools are not required to install electrical in the Evolve Panel System.

Voice and Data can be run at the following levels:

- Standard Panels—Base of the panel.
- Beltline Panels—Base, Beltline of the panel.
- Beltline Light Panels—Beltline of the panel.

Electric can be run at the following levels:

- Standard Panels—Base raceway
- Beltline Panels—Base and/or Beltline raceway
- Light Panels—Do not contain a raceway for electric.
- Beltline Light Panels—Beltline raceway

Additional Data and Electric Options

- A panel mounted power bar can be mounted on-module at any level and contains a 14' cord.
- Desktop modules are available to install in the worksurface scoop for electric and data.
- 6" Vertical Panel provides electric and data above the worksurface and electric just below the worksurface.

Electric Information

- Electric can be run in any raceway whether it is at the base or Beltline.
 - 8-Wire, 4-Circuit Capability
 - 2 Utility + 2 Dedicated Circuits
 - 10 Gauge (oversized) Neutrals.
- All circuits can support up to 20 amps (15 CSA).

Raceway Information

- Raceway knockouts sizes conform to the ANSI/TIA/EIA Furniture Opening Standard of 1.38" x 2.71" at the base and Beltline.
- Panels 24" wide include raceway covers with one knockout.
- Panels 30" wide include raceway covers with two knockouts.
- Panels 36"-60" wide include raceway covers with three knockouts.
- Standard data face mount plates can be used without the need of adapter plates (supplied by others).

Cabling Capacities

(calculations below are based on CAT5 cables)

Base Raceway – for Standard and Beltline Panels

- Without Electric – 140 Cables
- With Electric – 48 Cables

Beltline Raceway – for Beltline and Light Beltline Panels

- Without Electric – 65 Cables
- With Electric – 54 Cables

Panel Connectors - 45 Degree Connectors Posts

- Without Electric – 20 Cables
- With Electric – 6 Cables

Panel Connectors - 60 Degree Connector Posts

- Without Electric – 20 cables
- With Electric – 6 Cables

Post Extension - 90 Degree Post

- Without Electric - 45 Cables
- With Electric - 25 Cables

Post Extension - 45 Degree Post

- Without Electric - 20 Cables
- With Electric - 6 Cables

Post Extension - 60 Degree Post

- Without Electric - 20 Cables
- With Electric - 6 Cables

WORKSURFACES

- NOTE: Worksurfaces come in a variety of shapes and sizes.

Worksurface Options

- Standard worksurface depths are 18"d, 24"d and 30"d.
- Standard worksurface widths range from 24"w – 84"w standard depending on the shape.



Worksurface Laminate Options

- Thermally Fused – 1" thick
- High Pressure – 1-1/16" thick
- High Pressure – 1-7/16" thick
- Wood Veneer – Contact Customer Support for Quotes

Worksurface Information

- Cable scoops are located in the back of each worksurface to route power and data cables
- Depth from center of scoop to panel is 1-1/8".
- Once installed there is a 3/8" gap between the worksurface and the panels for additional cabling needs.
- Custom sizes are available, contact Customer Support for Quotes.
- Metal inserts are standard for a metal to metal connection between the worksurface and the supporting hardware. This will allow product to be reconfigured many times and still perform.
- All worksurfaces utilize balanced construction.

STORAGE

Pedestals

- Available as Worksurface Supporting, Freestanding and Mobile.
- Mobile pedestals are available with or without a cushion. Mobile pedestals with a cushion can have an upholstery fabric applied to them.
- Standard Pedestal Depths are 18"d, 19"d, 23"d, 24"d, 29"d and 30"d
- Pedestal widths are 15"w. Please note maximum extension of pedestal glide is 1".

File Drawers

- 150 lb Full Extension Slides
- Full height drawer sides are standard on all File drawers which enables the hanging of files from the drawer side so no extra hardware is necessary. File drawers accept legal, letter and metric sized files.

Box Drawers

- 75 lb Single Action Slides

Drawer Information

- Steel construction guarantees the performance of the product over the long term.
- Welded joints with a full top, back and base ensure that the pedestal will sit square and adequately support the worksurface where necessary.
- Double wall drawer face
- 20 gauge steel
- Metal roller ball bearing slides
- Adjustable glides are accessible from the inside of the pedestal.
- Standard positive and secure locking system.
- Epoxy powder coated.
- Locks can be keyed alike or master keyed*. Please note Key list(s) required to key alike.
- *Master Key must be ordered separate.
- Standard recessed handle offers uncluttered aesthetic.

Lateral Files

- All lateral files are 18" deep
- Standard widths are 30"w, 36"w and 42"w.
- Standard EV12 Heights are 27.75"h, 40.5"h, 54"h and 65.88"h.
- Available with fixed front drawers, receding doors with roll-out shelf, and half height drawers (See page 184 for more information Lateral File)

Lateral File Information

- Drawer anti-locking system
- Three Stage, anti-bounceback suspension
- Receding door features 16 gauge, spring loaded hinges
- Premium drawer slides with black zinc coating for smoother, quieter motion.
- Pre-Installed file bars
- 18-20 gauge steel
- Adjustable glides are accessible from the inside of the lateral file. Please note maximum extension for lateral glide is 5/8"

Storage Towers

- Features all metal construction and a choice of 20 different configurations.
- Heights include 50"h, 54"h and 65.875"h. 42"h and 48"h available upon request.
- 24"w x 24"d
- Side shelving available.

Bookcases and Storage Cabinets

- Features all metal construction.
- Available in widths of 30"w, 36"w and 42"w.
- Heights include 27.75"h, 40.5"h, 54"h and 65.88"h.

Overhead Storage

- Standard widths include 24"w (not available on all units), 30"w, 36"w, 42"w, 48"w, 54"w and 60"w. Please note ADA and Double Wall Overheads are not available in 24"
- Standard heights range from 12"h to 17.5"h.
- Overhead Options
- Flat Front 12" Flipper Door
- Full Pull 13" Flipper Door
- Full Pull Double Wall Flipper Door (also available with shelf option)
- Full Pull 16" Flipper Door (door retracts inside cabinet)
- Sliding glass doors
- ADA Compliant Overhead with soft close mechanism
- High and Low Profile Shelf
- A magnetic whiteboard is available for metal front overheads.

WARRANTIES AND PERFORMANCE

- A Lifetime Warranty
- Non Obsolescence Warranty
- Reduced cost of assembly and reconfiguration
- ISO9001:2000 Registered
- ISO14001:2004 Registered
- GreenGuard Certified
- ANSI/BIFMA CGSB testing on all products
- For piece of mind over the long term, we cover you with a comprehensive warranty that is supported by our dealer network.
- Some installation companies claim that the Evolve Panels System can be installed in half the time it takes to install most of our competitor's segmented panels. This cost saving can amount to thousands of dollars over the lifetime of our furniture.
- Your assurance of consistent quality to an international standard. Evolve Systems is committed to design, manufacture and distribute superior quality office furniture, which meets or exceeds the requirements of our customers.
- Confirmation that Evolve is committed (1) to providing product that, through their entire life cycle, minimize negative environmental impacts on the environment, (2) to continuous improvement to our environmental systems and programs and (3) to comply to all relevant environmental legislation and regulations.
- Evolve Systems can help a company meet LEED requirements for office furniture.
- Evolve components are tested to the highest standard in the industry. This is your assurance of quality and longevity.

Evolve products have been coded using alphas that correspond with the product name. This creates an easy-to-remember code. The following breaks down the coding logic and highlights the required code components needed to order within each product category.

PANELS

Example:

Product: Segmented Panel

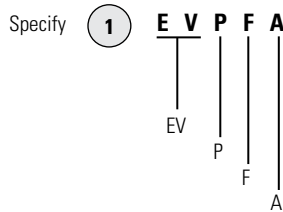

Base Code found on the product page to the left of the product name and a simple product illustration.

EVolve product line

Panel category

Fabric-covered or partly fabric-covered Panel

Acoustic Panel
(EVPF P – represents Premium Acoustic)

2 EVPFA**6648**

Panel size offering. Listed on every product page with price listing.
Note: Additional dimensions are provided for most products on the far right hand side of each page. These dimensions are not required in the ordering code.

3 EVPFA6648 –**BLK**

Finish code for frame. See Textiles & Finishes pages 251-252.

To specify fabric for an Evolve Panel, please note:

4 EVPFA6648–BLK–**B84A**

Fabric code for all modules on both sides of the Panel*.
See Textiles & Finishes pages 251-252.

*** NOTE:** If different fabrics are to be included on an Evolve Panel, please use the following ordering format. **Start at the bottom** of one side of a Panel and work to the top module of that Panel. Then start the process over on the other side of the Panel. As an example:

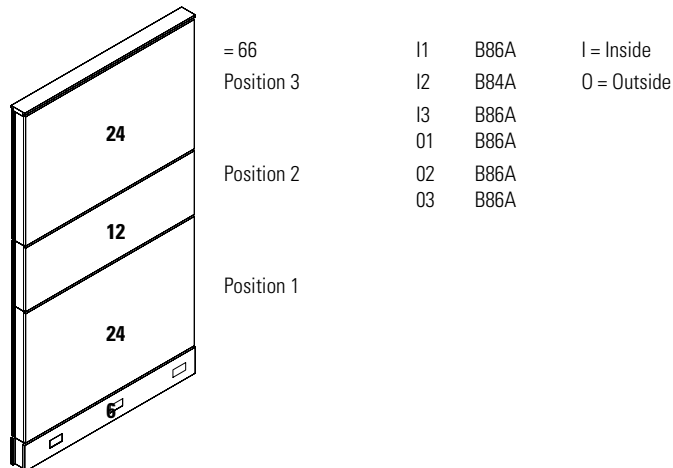

ELECTRICAL

Example: Product: Pass-Through Cables

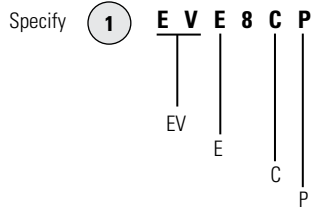

Base Code found on the product page to the left of the product name and a simple product illustration.

EVolve product line

Electrical category

Cable Panel.

Pass-Through.

2 EVE8CP40

Product size offering – length. Listed on every product page with price listing. Note: Additional dimensions are provided for most products on the far right hand side of each page. These dimensions are not required in the ordering code.

WORKSURFACES

Example: Product: Curvilinear Worksurface - Left

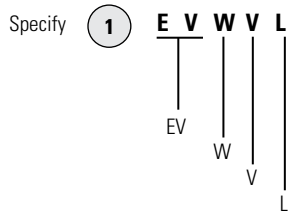

Base Code found on the product page to the left of the product name and a simple product illustration.

EVolve product line

Worksurface category

Cur**V**ilinear shape

Left hand configuration

2 EWWWL3042

Worksurface size offering. Listed on every product page with price listing. Note: Additional dimensions are provided for most products on the far right hand side of each page. These dimensions are not required in the ordering code.

3 EWWWL3042–T431

Laminate code for surface. See Textiles & Finishes pages 251-252.

4 EWWWL3042–T431–CHR

PVC code for trim. See Textiles & Finishes pages 240-241.

WORKSURFACES - HARDWARE

Example:

Product:

End Panel

Specify

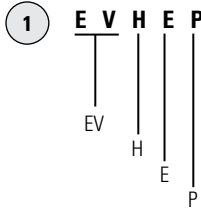

Base Code found on the product page to the left of the product name and a simple product illustration.

EVolve product line

Hardware category

End Panel.

End **P**anel.

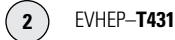

Laminate code for End Panel. See Textiles & Finishes pages 251-252.

STORAGE

Example:

Product:

Box, Box, File Pedestal

Specify

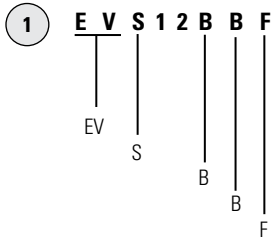

Base Code found on the product page to the left of the product name and a simple product illustration.

EVolve product line

Storage category

Box drawer

Box drawer

File drawer

ACCESSORIES

Example:

Product:

White Board

Specify

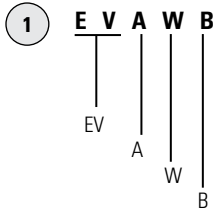

Base Code found on the product page to the left of the product name and a simple product illustration.

EVolve product line

Accessories category

White Board

White Board



panels

TECHNICAL FEATURES OF EVOLVE PANELS:

- Evolve Panels are 2 7/8" thick.
- An aluminum low profile top cap is included with the panel.
- Base Raceway will allow for 140 data cables without electrical, or 48 data cables with electrical.
- Beltline Raceway will allow for 65 data cables without electrical or 54 data cables with electrical.
- 90 degree post extension will allow for 45 data cables without electric and 25 data cables with electric.
- Raceway knockout openings are 1.38" x 2.71".
- Acoustic Rating: .65 = NRC - Noise Reduction Coefficient
- STC: 23 = Sound Transmission Coefficient

BASIC FEATURES OF EVOLVE PANELS:

- Evolve Segmented Panels are available in four (4) basic heights: 30", 42", 54" and 66"; and eight (8) widths: 18", 24", 30" 36", 42", 48", 54" High and 60".
- Evolve Monolithic Panels are available in four (4) basic heights: 42", 48", 54" and 66"; and eight (8) widths: 18", 24", 30" 36", 42", 48", 54" and 60".
- Evolve Panels must include the same segmentation on both sides of the panel. Cannot be Monolithic on one side and Segmented on the other.
- Opposite sides of each Fabric Module may have a different fabric within the same grade at no upcharge.
- If different grades of fabric are used on one panel, the entire panel must be priced at the highest grade.
- There is no panel creep in a straight Panel-to-Panel configuration; however, a corner post (2, 3, 4 way) will add 3.25" inches to a panel run.
- All Fabric Acoustic Panels (EVPFA) are composed of a 6" raceway module and a 24" base-height module which create the EVPFA30. Subsequent heights are created by adding either a 12" high module to create an EVPFA42 or a 24" high module to create an EVPFA54. The addition of both 12" and 24" modules creates a EVPFA66.
- In contrast, a Premium Panel (EVFPF) is composed of a 6" raceway module, a 24" base-height module and either two (2) or three (3) 12" modules which make up the two premium heights: EVFPF54 and EVFPF66.
- All Panels available with Aluminum trim as a standard option.
- Individual fabric covered acoustic modules incorporated into a rigid steel frame.
- Raceway covers included with panels
- Beltline Panels contain a 6" Power Belt Module that is metal with knockouts on both sides.

BASIC FEATURES OF EXTENSION MODULES:

- Stackability: Evolve Panels can be increased in height in 6", 12", 18" or 24" increments. See Extension Module (pages 82-90) for part numbers.
- Panel Extension Modules stack on the top of a Panel.
- Modules can be stacked to add privacy or divide space.
- Opposite sides of a fabric module may have a different fabric within the same grade at no upcharge.
- If different grades of fabric are used on one Panel, the entire Module must be priced at highest grade.

GENERAL WARRANTY INFORMATION:

- Panel and tackboard textiles, adjustable keyboard mechanisms, tasklights and electrical devices = ten (10) Years
- Other parts = Lifetime Warranty



MONOLITHIC PANELS - PAGES 22-27

Monolithic Panel

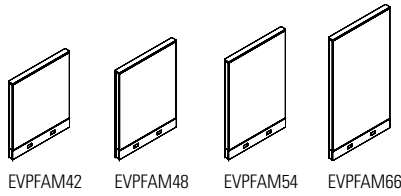

Monolithic Light Panel

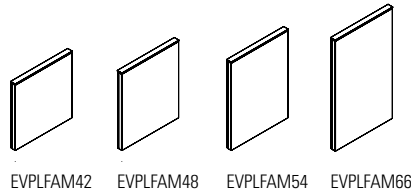

Monolithic Beltline Powered Panel

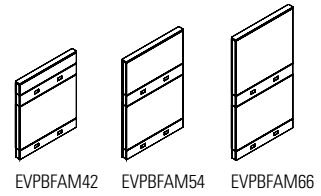

Monolithic Beltline Powered Light Panel

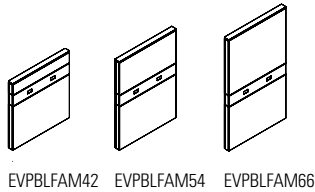

Monolithic Beltline Powered Chimney Panel

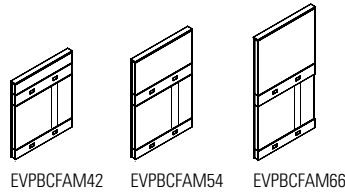

Chimney Jumper Cable Kit

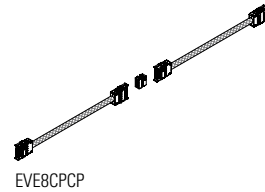

Monolithic Beltline Non-Powered Panel

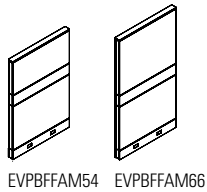

Monolithic Beltline Non-Powered Light Panel

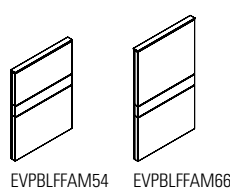

SEGMENTED PANELS - PAGES 28-33

Segmented Panel

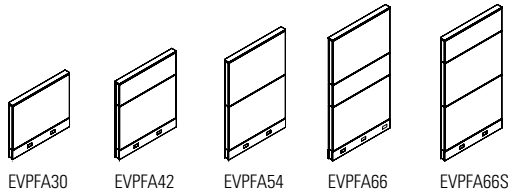

Segmented Light Panel

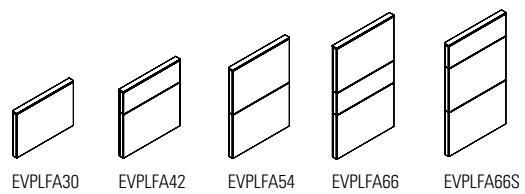

Segmented Premium Panel

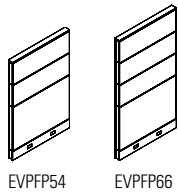

Segmented Premium Light Panel

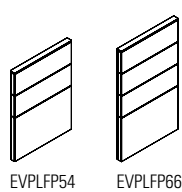

Segmented Beltline Powered Panel

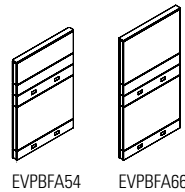

Segmented Beltline Powered Light Panel

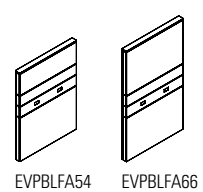

Segmented Beltline Powered Chimney Panel

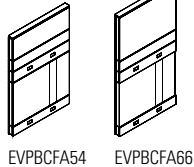

Chimney Jumper Cable Kit

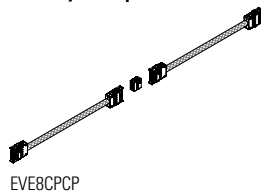

Segmented Beltline Non-Powered Panel

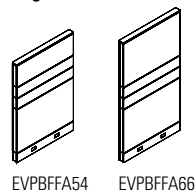

Segmented Beltline Non-Powered Light Panel

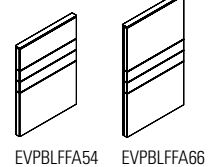

PARTLY GLAZED - TEMPERED GLASS PANELS - PAGES 34-43

Monolithic 12"H Glazed Panel

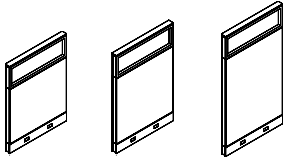

EVPMGU48 EVPMGU54 EVPMGU66

Monolithic 12"H Glazed Light Panel

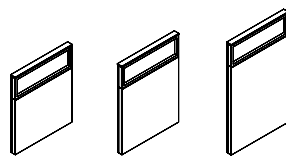

EVPLMGU48 EVPLMGU54 EVPLMGU66

Segmented 12"H Glazed Panel

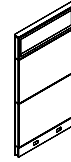

EVPGTU66

Segmented 12"H Glazed Light Panel

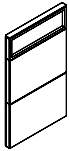

EVPLFGTU66

Segmented 12"H Glazed Premium Panel

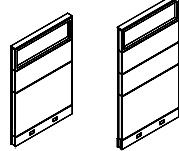

EVPPFGTU54 EVPPFGTU66

Segmented 12"H Glazed Premium Light Panel

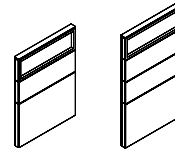

EVPLFPGTU54 EVPLFPGTU66

Partly Glazed Panel

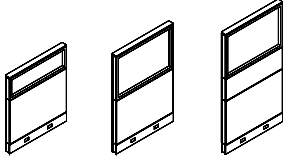

EVPGT42 EVPGT54 EVPGT66

Partly Glazed Light Panel

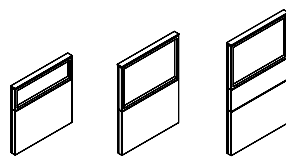

EVPLFGT42 EVPLFGT54 EVPLFGT66

Partly Glazed Panel - 36"H



EVPGTX66

Partly Glazed Light Panel - 36"H

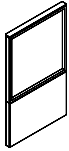

EVPLFGTX66

Partly Glazed Beltline Powered Panel

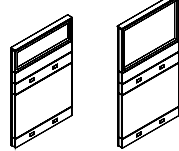

EVPBFGT54 EVPBFGT66

Partly Glazed Beltline Powered Light Panel

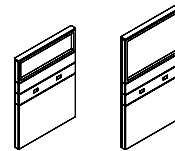

EVPLBFGT54 EVPLBFGT66

Partly Glazed Beltline Powered Chimney Panel

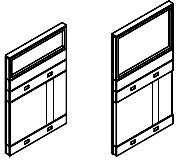

EVBCFGT54 EVBCFGT66

Chimney Jumper Cable Kit

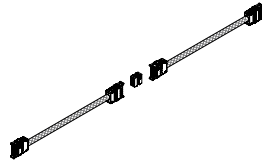

EVE8CPCP

Partly Glazed Premium Panel

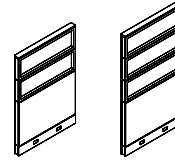

EVPPFGT54 EVPPFGT66

Partly Glazed Premium Light Panel

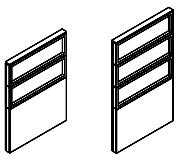

EVPLFPGT54 EVPLFPGT66



FULLY GLAZED - TEMPERED GLASS PANELS - PAGES 44-47

Fully Monolithic Panel

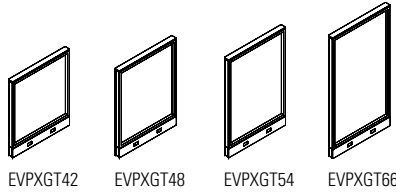

Fully Monolithic Light Panel

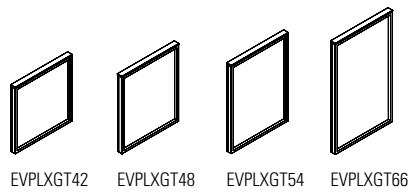

Fully Glazed Segmented Panel



Fully Glazed Segmented Light Panel

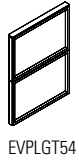

Fully Glazed Premium Panel

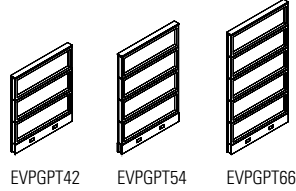

Fully Glazed Premium Light Panel

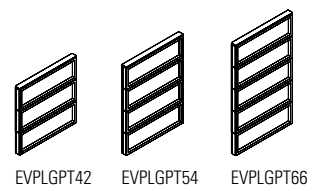

PASS-THRU SLIDING DOOR - PAGES 50-51

Pass-Thru Sliding Door Glazed Panel

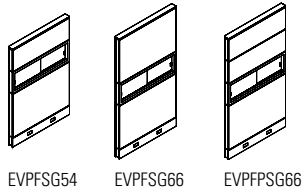

Fabric Glazed Pass-Thru Sliding Door Panel

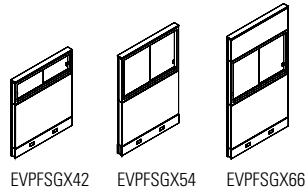

SLATWALL PANELS - PAGES 52-58

Slatwall Panel - Single Sided

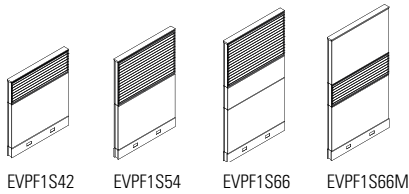

Slatwall Light Panel - Single Sided

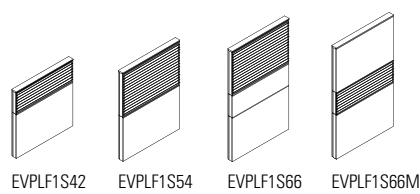

Slatwall Panel - Double Sided

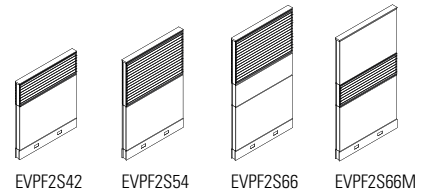

Slatwall Light Panel - Double Sided

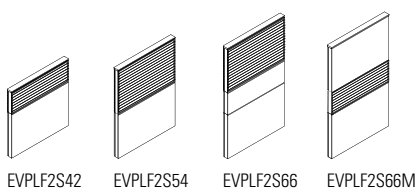

Frameless Slatwall Panel - Double Sided

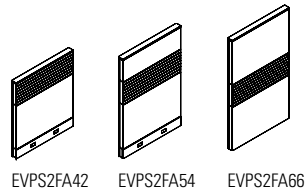

Frameless Slatwall Beltline Powered Panel - DS

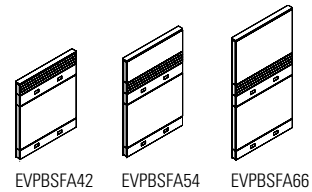

Frameless Slatwall Beltline Powered Light Panel - DS

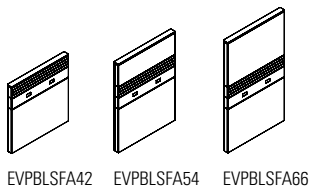

Frameless Slatwall Beltline Powered Chimney Panel - Double Sided

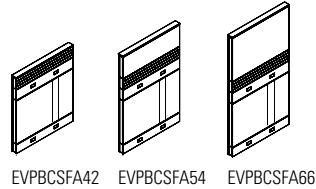

Chimney Jumper Cable Kit

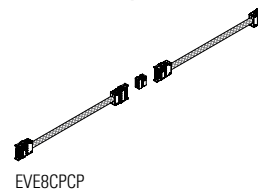

WRITE BOARD PANELS - PAGES 59-60

Write Board Panel - Single Sided

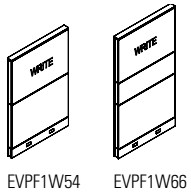

Write Board Light Panel - Single Sided

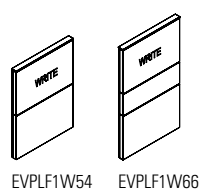

Write Board Panel - Double Sided

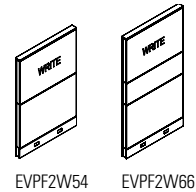

Write Board Light Panel - Double Sided

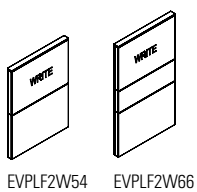

LAMINATE PANELS - PAGES 61-64

Laminate Panel - Single Sided

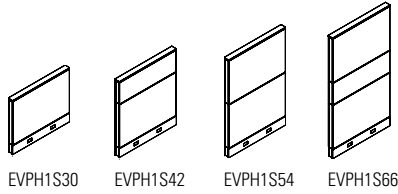

Laminate Light Panel - Single Sided

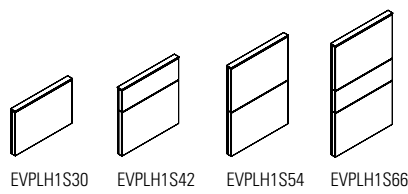

Laminate Panel - Double Sided

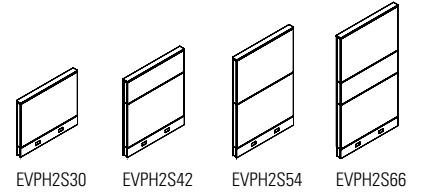

Laminate Light Panel - Double Sided

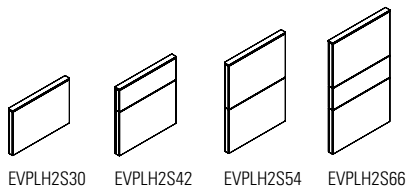

AIRFLOW PANELS - PAGES 65-68

Airflow Panel

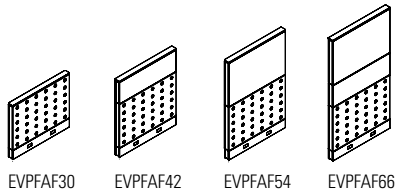

Airflow Light Panel

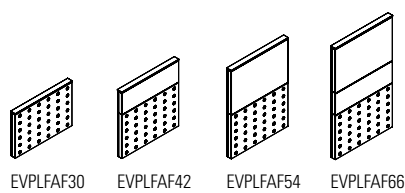

Airflow Premium Panel

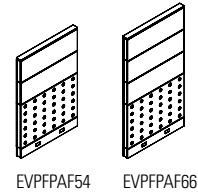

Airflow Premium Light Panel

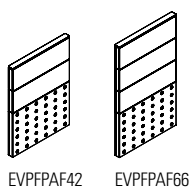

Airflow Middle Premium Light Panel

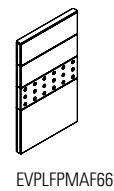

METAL SKIN PANELS - PAGES 69-72

Metal Skin Panel - Single Sided

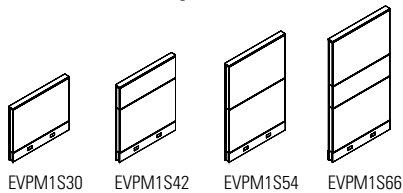

Metal Skin Light Panel - Single Sided

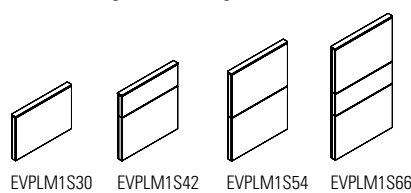

Metal Skin Panel - Double Sided

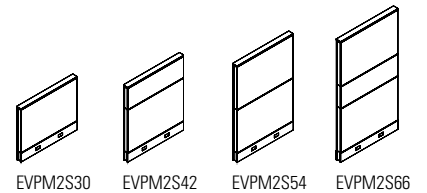

Metal Skin Light Panel - Double Sided

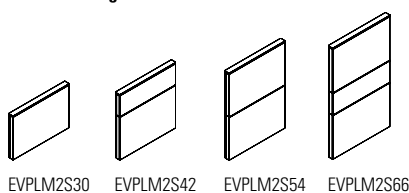

OPEN PANELS - PAGES 73-78

Open Bottom Panel

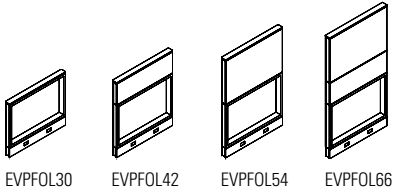

Open Bottom Light Panel

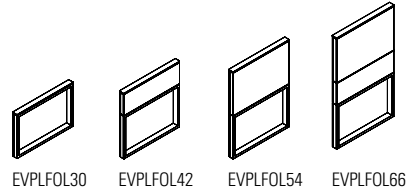

Open Bottom Premium Panel

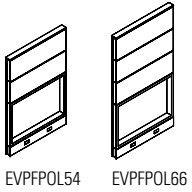

Open Bottom Premium Light Panel

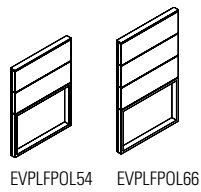

Open Middle Panel - 12"H Opening

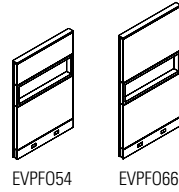

Open Middle Light Panel - 12"H Opening

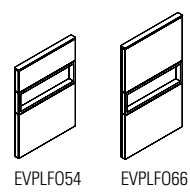

Open Middle Premium Panel - 12"H Opening

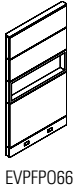

Open Middle Premium Light Panel - 12"H Opening

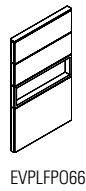

Open Middle Panel - 24"H Opening

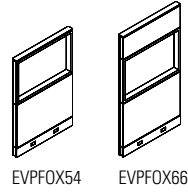

Open Middle Light Panel - 24"H Opening

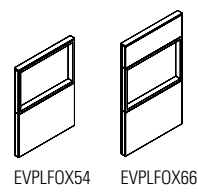

NO RACEWAY PANELS - PAGES 79-91

Segmented

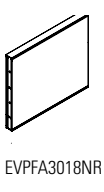

Monolithic

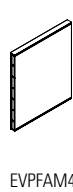

Laminate - Single Sided

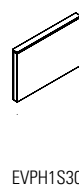

Laminate - Double Sided

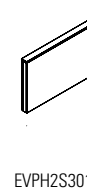

Fully Glazed Monolithic

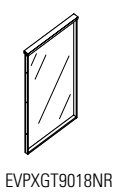

Inline Connector

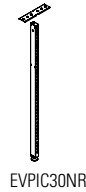

End of Run

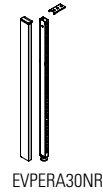

Corner Post - One Way

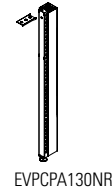

Inline Corner Post - Two Way

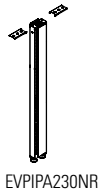

Corner Post - Two Way

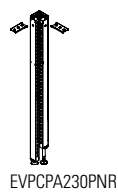

Corner Post - Three Way

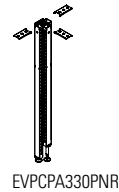

Corner Post - Four Way

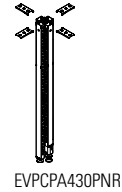

GALLERY PANELS - PAGES 92-105

Laminate Double Sided Finished Ends



EVLEPDS4251NC

Laminate Double Sided Connector Ends



EVLEPDS4251

Laminate Single Sided Finished Ends



EVLEPSSL4227NC

Laminate Double Sided Connector Ends



EVLEPSSL4227

Laminate Double Sided Middle Base Power, Finished Ends



EVLEPDC4251NC

Laminate Double Sided Middle Beltline Power, Finished Ends



EVICLXP4251NC

Laminate Double Sided Base Power, Connector Ends



EVLEPDC4251

Laminate Double Sided Middle Beltline Power, Connector Ends



EVICLXP4251

Laminate Single Sided Middle Base Power, Finished Ends



EVLEPSC4227NC

Laminate Single Sided Middle Base Power, Connector End



EVLEPSC4227

Laminate Single Sided Middle Beltline Power, Finished Ends



EVLEPSCB4227NC

Laminate Single Sided Middle Beltline Power, Connector End



EVLEPSCB4227

Laminate Gallery Extension Finished End



EVLXPML4224NC

Laminate Gallery Straight Extension, Connector Ends



EVLXPML4224

Laminate Gallery Two-Way Extension, Finished Ends



EV2LXPL4225

Laminate Gallery Three-Way Extension, Finished Ends



EV3LXPL4249

Laminate Double Gallery for Four-Way, Finished Ends



EV4LXP4249

Laminate Extension Panel for Four-Way, Finished Ends



EV4LXPM4224

Panel Connector with U Channel



EVPERCH42

Panel Connector w/U Channel For Beltline Panels

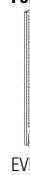

EVPPERCH42

Laminate Gallery Panel Bottom Bracket



EVHLPBB01

Laminate Gallery Panel Corner Bracket



EVHLPBB01

Connector w/U Channel Top Trim Aluminum



EVPTTAU24

1" LAMINATE PANELS - PAGES 106-108

1" Laminate End Panel

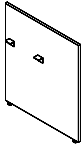

EVLEPR42

1" Laminate Middle Panel

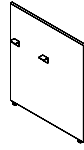

EVLMP42

1" Laminate End Panel w/ Accessory Rail

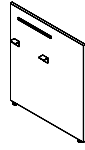

EVLEPR42A

1" Laminate Middle Panel w/ Accessory Rail



EVLMP42A

Double Inline Panel Connector

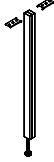

EVPDIC42

Beltline DoubleInline Panel Connector

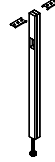

EVBDIC42

Double Inline Connector Trim

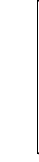

EVPDVTF42

Double Inline Panel Connector Top Trim - Aluminum

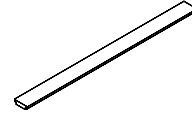

EVPTTA25

DOOR PANELS - PAGES 110-112

Door Panel - Solid

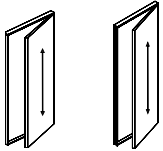

EVPS84

EVPS90

Knob Lock Set

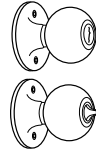

EVPSL01

Lever Lock Set



EVPSL02

Sliding Door Lock

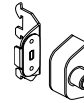

EVPSLLOCK

Sliding Privacy Door

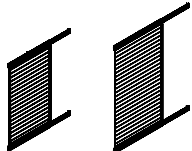

EVPSL66

EVPSL81

Mini Panel Kit

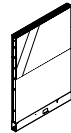

EVMPK02

Low Profile Foot

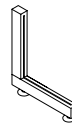

EVHLPF01



PRIVACY PANELS - PAGES 149-164

Glazed Monolithic Privacy Panel



EVPPXGTF4218

Ribbed Monolithic Privacy Panel



EVPPXGR4218 EVPPXGR4218M EVPPXGRF4218

78" Glazed Monolithic Privacy Panel



EVPPXGT7824 EVPPXGT7824M EVPPXGTF7824

Glazed Privacy Panel



EVPPGT5424 EVPPGT5424M

Glazed Privacy Panel

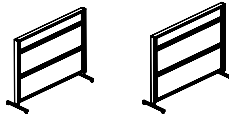

EVPPGT6624 EVPPGT6624M

Laminate Glazed Privacy Panel



EVPPHGTU5424 EVPPHGTU5424M

Laminate Glazed Privacy Panel

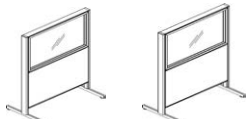

EVPPHGT5424 EVPPHGT6624M

Laminate Privacy Panel

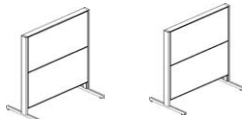

EVPPH2S5424 EVPPH2S5424M

Write Board Glazed Privacy Panel

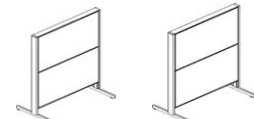

EVPPF2W5424 EVPPF2W5424M

Write Board Laminate Privacy Panel

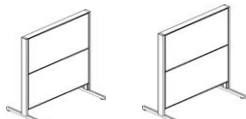

EVPPH2W5424 EVPPH2W5424M

This page provides an exploded view of a sample configuration highlighting each **Panel** component required when specifying this configuration.

Components

- | | |
|--|---|
| <p>A. EVPERA66 End-of-Run Kit (Wall mount) Note: adds 1" to the width of a Panel Run.</p> <p>B. EVPFA6636 Segmented Panel</p> <p>C. EVPIC66 Inline Panel Connector</p> <p>D. EVPCPA266 Two-Way Corner Post Note: Trim kit included. Post Connectors can be custom manufactured with or without slots. Contact your Evolve Customer Support Representative for a special quote.</p> | <p>E. EVPVC66 Variable-Height Connector Note: Connector height must reference taller Panel.</p> <p>F. EVPTVA24 Panel Trim Variable-Height</p> <p>G. EVPFA4236 Segmented Panel</p> |
|--|---|

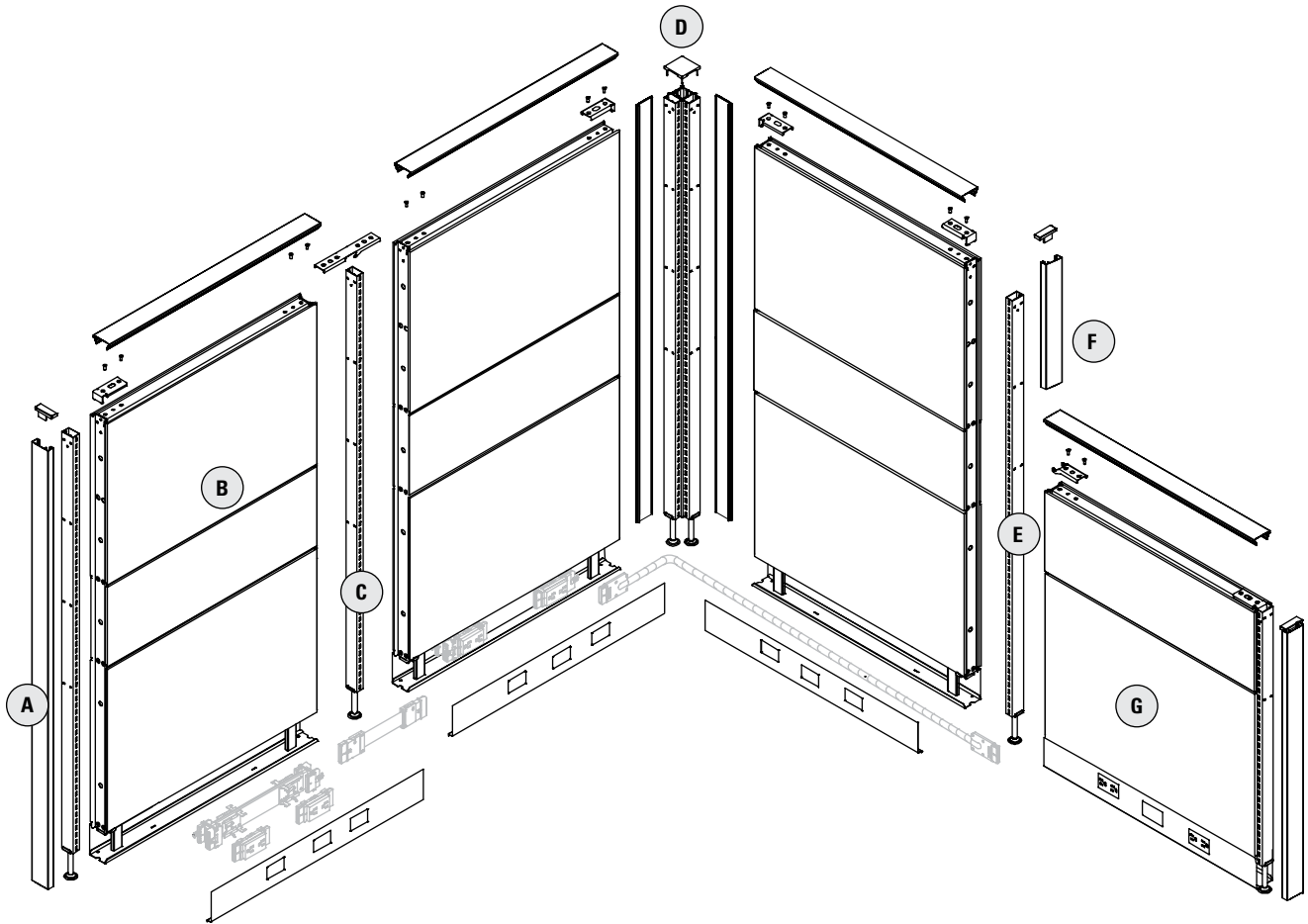

This page provides an exploded view of a sample configuration highlighting each **Beltline Power Panel** component required when specifying this configuration.

Components

- | | |
|---|---|
| <p>A. EVPERA66 End-of-Run Kit (Wall mount) Note: adds 1" to the width of a Panel Run.</p> <p>B. EVPBCFAM6636 Monolithic Beltline Powered Chimney Panel</p> <p>C. EVPBIC66 Inline Panel Connector for Beltline Electric Panels</p> <p>D. EVPBIPA266 Two-Way Corner Post for Beltline Electric Panels Note: Trim kit included. Post Connectors can be custom manufactured with or without slots. Contact your Evolve Customer Support Representative for a special quote. Note: All beltline post connectors come with PVC covers to install at beltline height on all sides.</p> | <p>E. EVPVC66 Variable-Height Connector for Beltline Electric Panels Note: Connector height must reference taller Panel.</p> <p>F. EVPTEA24 Panel Extension Trim</p> <p>G. EVPBFAM4236 Monolithic Beltline Powered Panel</p> |
|---|---|

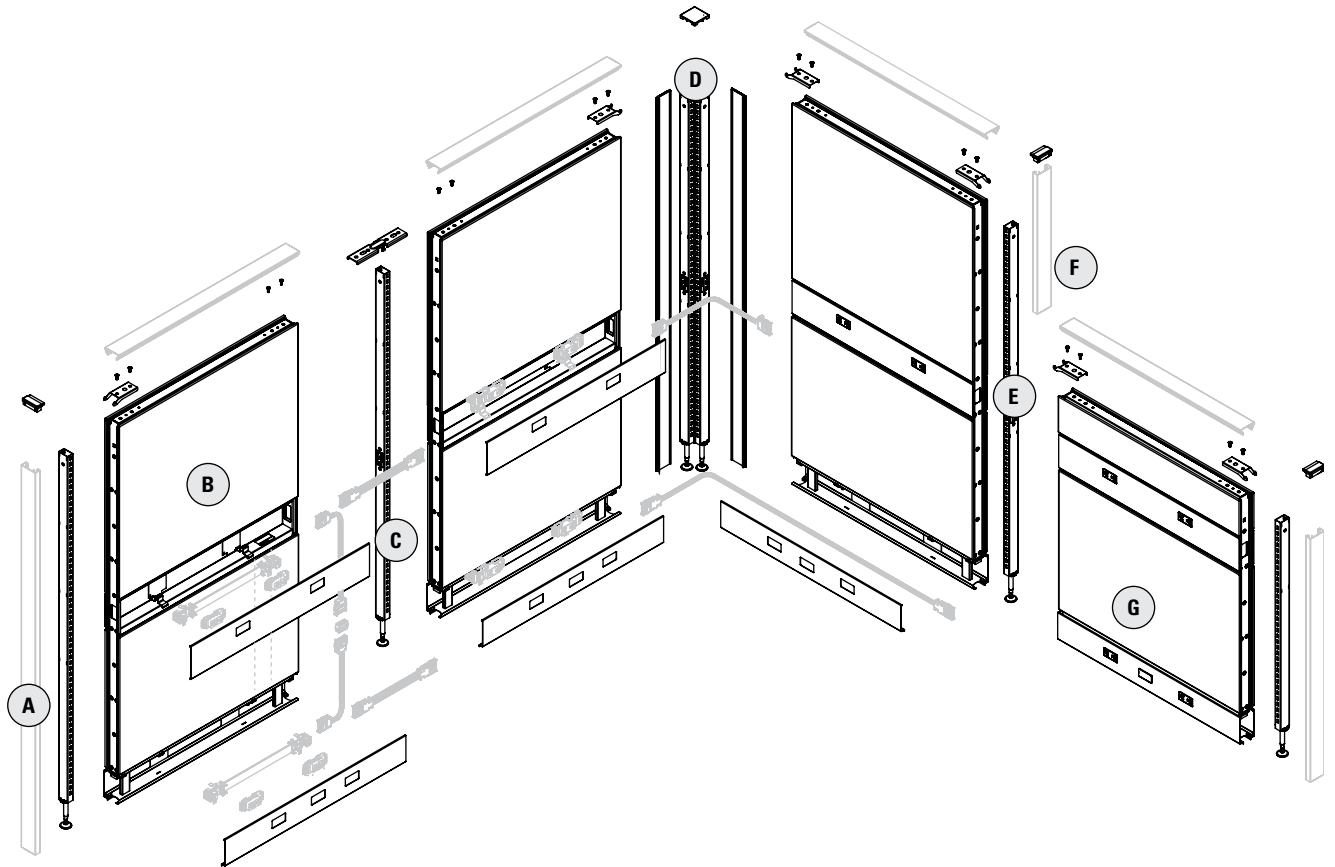

EACH ORDER MUST INCLUDE:

- Purchase Order
- Layout showing where the image(s) appear in the run of panels.
- A completed Price Chart, showing the location of the image(s) on each appropriate panel.
- Artwork must be submitted in accordance with the following artwork specifications.
- NOTE: Final artwork specification approval must be given before order can be processed.

TRANSFER DEVICES

- Email up to 10MB to your Evolve Customer Service Representative.
- Courier CD/DVD/USB drive to your Evolve Customer Service Representative.

ARTWORK SPECIFICATIONS

- Non-Photographic artwork should be vector art. Saved in Adobe Illustrator (.ai) or as an EPS (.eps)
- All bitmap or photographic artwork has to be at a minimum of 100 dpi at the full size of the panel to be printed.
- We accept Adobe CS5 files.
- Any linked files must be included or imbedded.
- Leave any PSD files un-flattened
- All fonts must be converted to outlines.
- Do not convert to CMYK, leave all images as RGB if possible
- No Word, Powerpoint, Publisher or other Microsoft files can be used.
- Include a PDF or .jpg for reference when sending native Photoshop or Illustrator format files.

COLOR MATCHING

- A Pantone color reference must be supplied or we cannot accept responsibility for correct color or color correction.
- When it is not possible to refer to Pantone colors, we will do our best to meet your requirements.

IMAGE CLARITY

- We will advise should the selected image not lend itself to the element size requested.

NOTE:

- We reserve the right to put an order on hold when the files are found to be incomplete or when documents have been either incorrectly saved, fonts have not been converted to curves or the job appears not to be commercially acceptable.

IMAGE BLEED:

- To facilitate placement on the panel. Extension of the image past the finished visible area of the panel (bleed) is required.
- Evolve Panels need a 3.5" bleed on all sides



EXAMPLE OF IMAGE RESOLUTION:

- The resolution required for a 36 wide x 24 high Evolve panel at 100dpi (minimum resolution)

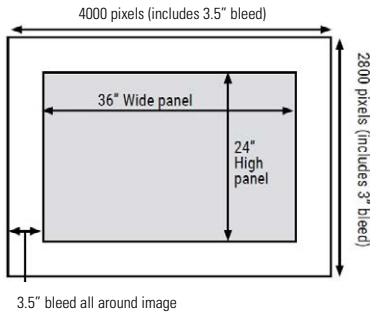

The resolution required for a 36 wide x 24 high Evolve panel at 300dpi (higher quality)

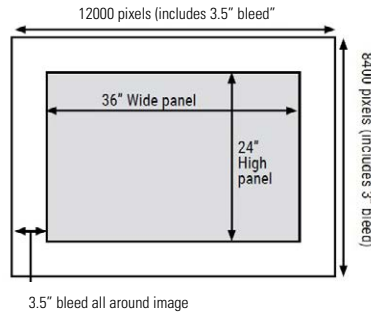

EVOLVE SYSTEMS - GRAPHIC PANEL EXAMPLE PROCEDURE

STEP 1: Customer orders the following EVPFA6636 panel with;

- Bottom module inside face (24/36 size fabric) with image 01.
- Middle module inside face (12/36 size fabric) with image 02.
- All other fabric material is regular fabric - top module inside face and all outside module faces.

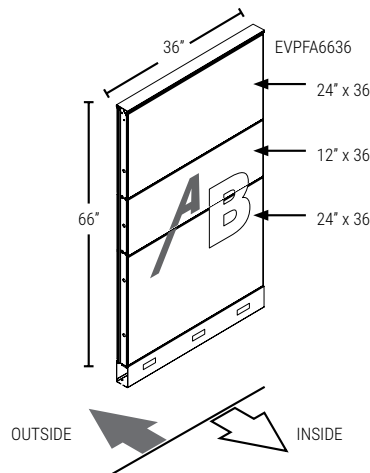

Note: To order, please use graphic codes below

- (A)
EVPGRP1236
- (B)
EVPGRP2436

STEP 2: On the regular panel - replace fabric pieces with corresponding graphic pieces.

STEP 3: On the regular panel - replace fabric pieces with corresponding graphic pieces.

- EVPGRP1236 for the middle module inside face
- EVPGRP2436 for the bottom module inside face

EVGGRP - 6”H GRAPHIC FABRIC FACTORY INSTALLED

- Graphic fabric for one side of 6” module.
- Graphic fabric to be installed at factory at specified 6” H module of fabric panel
- Fabric panel not included. Prices shown are an upcharge to the applicable panel price. Please add the upcharge to the list price of the panel on which you are specifying a graphic.
- Applies to the following panels: EVPFA, EVFPF, EVPF1W, EVPF2W, EVPF1S, EVPF2S, EVPFGT, EVFPFGTU, EVPFOL, EVFPOL, EVPFO, EVFPFO, EVPFE, EVPFPE
- Note: initial set up charge is \$250 net per image

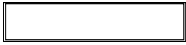
| | DESCRIPTION | PRODUCT CODE | LIST PRICE | DIMENSIONS/INCHES | | |
|--|------------------------------|--------------|------------|-------------------|----|---|
| | | | | H | W | D |
|  | Graphic fabric for 6” Module | EVGGRP0624 | 159 | 6 | 24 | |
| | | EVGGRP0630 | 200 | 6 | 30 | |
| | | EVGGRP0636 | 240 | 6 | 36 | |
| | | EVGGRP0642 | 279 | 6 | 42 | |
| | | EVGGRP0648 | 319 | 6 | 48 | |
| | | EVGGRP0654 | 362 | 6 | 54 | |
| | | EVGGRP0660 | 403 | 6 | 60 | |

EVGGRP - 12”H GRAPHIC FABRIC FACTORY INSTALLED

- Graphic fabric for one side of 12” module.
- Graphic fabric to be installed at factory at specified 12” H module of fabric panel
- Fabric panel not included. Prices shown are an upcharge to the applicable panel price. Please add the upcharge to the list price of the panel on which you are specifying a graphic.
- Applies to the following panels: EVPFA, EVFPF, EVPF1W, EVPF2W, EVPF1S, EVPF2S, EVPFGT, EVFPFGTU, EVPFOL, EVFPOL, EVPFO, EVFPFO, EVPFE, EVPFPE
- Note: initial set up charge is \$250 net per image

| | DESCRIPTION | PRODUCT CODE | LIST PRICE | DIMENSIONS/INCHES | | |
|---|-------------------------------|--------------|------------|-------------------|----|---|
| | | | | H | W | D |
|  | Graphic fabric for 12” Module | EVGGRP1224 | 159 | 12 | 24 | |
| | | EVGGRP1230 | 200 | 12 | 30 | |
| | | EVGGRP1236 | 240 | 12 | 36 | |
| | | EVGGRP1242 | 279 | 12 | 42 | |
| | | EVGGRP1248 | 319 | 12 | 48 | |
| | | EVGGRP1254 | 362 | 12 | 54 | |
| | | EVGGRP1260 | 403 | 12 | 60 | |

EVGGRP - 18”H GRAPHIC FABRIC FACTORY INSTALLED

- Graphic fabric for one side of 18” module.
- Graphic fabric to be installed at factory at specified 18” H module of fabric panel
- Fabric panel not included. Prices shown are an upcharge to the applicable panel price. Please add the upcharge to the list price of the panel on which you are specifying a graphic.
- Applies to the following panels: EVPFA, EVFPF, EVPF1W, EVPF2W, EVPF1S, EVPF2S, EVPFGT, EVFPFGTU, EVPFOL, EVFPOL, EVPFO, EVFPFO, EVPFE, EVPFPE
- Note: initial set up charge is \$250 net per image

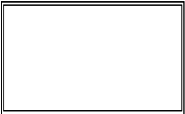
| | DESCRIPTION | PRODUCT CODE | LIST PRICE | DIMENSIONS/INCHES | | |
|--|-------------------------------|--------------|------------|-------------------|----|---|
| | | | | H | W | D |
|  | Graphic fabric for 18” Module | EVGGRP1824 | 314 | 18 | 24 | |
| | | EVGGRP1830 | 394 | 18 | 30 | |
| | | EVGGRP1836 | 476 | 18 | 36 | |
| | | EVGGRP1842 | 558 | 18 | 42 | |
| | | EVGGRP1848 | 638 | 18 | 48 | |
| | | EVGGRP1854 | 718 | 18 | 54 | |
| | | EVGGRP1860 | 801 | 18 | 60 | |



EVPGRP - 24”H GRAPHIC FABRIC FACTORY INSTALLED

- Graphic fabric for one side of 24” module.
- Graphic fabric to be installed at factory at specified 24” H module of fabric panel
- Fabric panel not included. Prices shown are an upcharge to the applicable panel price. Please add the upcharge to the list price of the panel on which you are specifying a graphic.
- Applies to the following panels: EVPFA, EVFPF, EVPF1W, EVPF2W, EVPF1S, EVPF2S, EVPFGT, EVFPFGTU, EVPFOL, EVFPFOL, EVPFO, EVFPFO, EVPFE, EVFPFE
- Note: initial set up charge is \$250 net per image

| DESCRIPTION | PRODUCT CODE | LIST PRICE | DIMENSIONS/INCHES | | |
|---|--------------|------------|-------------------|----|---|
| | | | H | W | D |
|  Graphic fabric for 24” Module | EVPGRP2424 | 314 | 24 | 24 | |
| | EVPGRP2430 | 394 | 24 | 30 | |
| | EVPGRP2436 | 476 | 24 | 36 | |
| | EVPGRP2442 | 558 | 24 | 42 | |
| | EVPGRP2448 | 638 | 24 | 48 | |
| | EVPGRP2454 | 718 | 24 | 54 | |
| | EVPGRP2460 | 801 | 24 | 60 | |

EVPGRP - 36”H GRAPHIC FABRIC FACTORY INSTALLED

- Graphic fabric for one side of 36” module (42” panel)
- Graphic fabric to be installed at factory on monolithic module
- Fabric panel not included. Prices shown are an upcharge to the applicable panel price. Please add the upcharge to the list price of the panel on which you are specifying a graphic.
- Applies to the following panels: EVPFAM
- Note: initial set up charge is \$250 net per image

| DESCRIPTION | PRODUCT CODE | LIST PRICE | DIMENSIONS/INCHES | | |
|---|--------------|------------|-------------------|----|---|
| | | | H | W | D |
|  Graphic fabric for 36” Monolithic Module | EVPGRP3624 | 476 | 36 | 24 | |
| | EVPGRP3630 | 613 | 36 | 30 | |
| | EVPGRP3636 | 733 | 36 | 36 | |
| | EVPGRP3642 | 854 | 36 | 42 | |
| | EVPGRP3648 | 975 | 36 | 48 | |
| | EVPGRP3654 | 1099 | 36 | 54 | |
| | EVPGRP3660 | 1220 | 36 | 60 | |

EVPGRP - 42”H GRAPHIC FABRIC FACTORY INSTALLED

- Graphic fabric for one side of 42” module (48” panel)
- Graphic fabric to be installed at factory on monolithic module
- Fabric panel not included. Prices shown are an upcharge to the applicable panel price. Please add the upcharge to the list price of the panel on which you are specifying a graphic.
- Applies to the following panels: EVPFAM
- Note: initial set up charge is \$250 net per image

| DESCRIPTION | PRODUCT CODE | LIST PRICE | DIMENSIONS/INCHES | | |
|--|--------------|------------|-------------------|----|---|
| | | | H | W | D |
|  Graphic fabric for 42” Monolithic Module | EVPGRP4224 | 559 | 42 | 24 | |
| | EVPGRP4230 | 712 | 42 | 30 | |
| | EVPGRP4236 | 854 | 42 | 36 | |
| | EVPGRP4242 | 997 | 42 | 42 | |
| | EVPGRP4248 | 1141 | 42 | 48 | |
| | EVPGRP4254 | 1281 | 42 | 54 | |
| | EVPGRP4260 | 1424 | 42 | 60 | |

EVPGRP - 48”H GRAPHIC FABRIC FACTORY INSTALLED

- Graphic fabric for one side of 48” module (54” panel).
- Graphic fabric to be installed at factory on monolithic module
- Fabric panel not included. Prices shown are an upcharge to the applicable panel price. Please add the upcharge to the list price of the panel on which you are specifying a graphic.
- Applies to the following panels: EVPFAM
- Note: initial set up charge is \$250 net per image

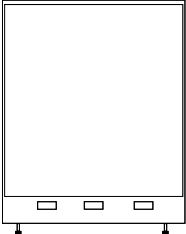
| | DESCRIPTION | PRODUCT CODE | LIST PRICE | DIMENSIONS/INCHES | | |
|---|--|--------------|------------|-------------------|----|---|
| | | | | H | W | D |
|  | Graphic fabric for 48” Monolithic Module | EVPGRP4824 | 636 | 48 | 24 | |
| | | EVPGRP4830 | 813 | 48 | 30 | |
| | | EVPGRP4836 | 975 | 48 | 36 | |
| | | EVPGRP4842 | 1141 | 48 | 42 | |
| | | EVPGRP4848 | 1302 | 48 | 48 | |
| | | EVPGRP4854 | 1466 | 48 | 54 | |
| | | EVPGRP4860 | 1627 | 48 | 60 | |

EVPGRP - 60”H GRAPHIC FABRIC FACTORY INSTALLED

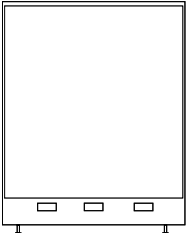

- Graphic fabric for one side of 60” module (66” panel).
- Graphic fabric to be installed at factory on monolithic module
- Fabric panel not included. Prices shown are an upcharge to the applicable panel price. Please add the upcharge to the list price of the panel on which you are specifying a graphic.
- Applies to the following panels: EVPFAM
- Note: initial set up charge is \$250 net per image

| | DESCRIPTION | PRODUCT CODE | LIST PRICE | DIMENSIONS/INCHES | | |
|---|--|--------------|------------|-------------------|----|---|
| | | | | H | W | D |
|  | Graphic fabric for 60” Monolithic Module | EVPGRP6024 | 801 | 60 | 24 | |
| | | EVPGRP6030 | 1018 | 60 | 30 | |
| | | EVPGRP6036 | 1220 | 60 | 36 | |
| | | EVPGRP6042 | 1424 | 60 | 42 | |
| | | EVPGRP6048 | 1627 | 60 | 48 | |
| | | EVPGRP6054 | 1829 | 60 | 54 | |
| | | EVPGRP6060 | 2033 | 60 | 60 | |





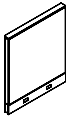

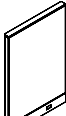
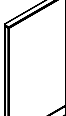
EVPFAM - MONOLITHIC PANEL

- Monolithic Panel incorporates fabric modules within a solid steel frame.
- Fabric covered modules are tackable and acoustical.
- Opposite sides of each panel may have a different fabric within the same grade at no upcharge.
- If different grades of fabric are used on one panel, the entire panel must be priced at highest grade.
- An aluminum low profile top cap is included.
- Stackability: Evolve panels can be increased in height in 6”H, 12”H, 18”H or 24”H increments. See Extension Modules for part numbers.

| | DESCRIPTION | PRODUCT CODE | LIST PRICE | | DIMENSIONS/INCHES | | |
|---|-----------------------------|--------------|------------|-----|-------------------|----|-------|
| | | | Gr1 | Gr2 | H | W | D |
|  | Monolithic Panel - 42" High | EVPFAM4218 | 363 | 398 | 42 | 18 | 2 7/8 |
| | | EVPFAM4224 | 389 | 428 | 42 | 24 | 2 7/8 |
| | | EVPFAM4230 | 445 | 495 | 42 | 30 | 2 7/8 |
| | | EVPFAM4236 | 475 | 532 | 42 | 36 | 2 7/8 |
| | | EVPFAM4242 | 525 | 593 | 42 | 42 | 2 7/8 |
| | | EVPFAM4248 | 572 | 648 | 42 | 48 | 2 7/8 |
| | | EVPFAM4254 | 629 | 711 | 42 | 54 | 2 7/8 |
|  | Monolithic Panel - 48" High | EVPFAM4818 | 368 | 403 | 48 | 18 | 2 7/8 |
| | | EVPFAM4824 | 405 | 449 | 48 | 24 | 2 7/8 |
| | | EVPFAM4830 | 469 | 519 | 48 | 30 | 2 7/8 |
| | | EVPFAM4836 | 511 | 568 | 48 | 36 | 2 7/8 |
| | | EVPFAM4842 | 570 | 636 | 48 | 42 | 2 7/8 |
| | | EVPFAM4848 | 618 | 692 | 48 | 48 | 2 7/8 |
| | | EVPFAM4854 | 684 | 769 | 48 | 54 | 2 7/8 |
|  | Monolithic Panel - 54" High | EVPFAM5418 | 373 | 408 | 54 | 18 | 2 7/8 |
| | | EVPFAM5424 | 411 | 454 | 54 | 24 | 2 7/8 |
| | | EVPFAM5430 | 477 | 527 | 54 | 30 | 2 7/8 |
| | | EVPFAM5436 | 531 | 590 | 54 | 36 | 2 7/8 |
| | | EVPFAM5442 | 592 | 658 | 54 | 42 | 2 7/8 |
| | | EVPFAM5448 | 644 | 719 | 54 | 48 | 2 7/8 |
| | | EVPFAM5454 | 706 | 792 | 54 | 54 | 2 7/8 |
|  | Monolithic Panel - 66" High | EVPFAM6618 | 460 | 496 | 66 | 18 | 2 7/8 |
| | | EVPFAM6624 | 504 | 548 | 66 | 24 | 2 7/8 |
| | | EVPFAM6630 | 570 | 623 | 66 | 30 | 2 7/8 |
| | | EVPFAM6636 | 664 | 722 | 66 | 36 | 2 7/8 |
| | | EVPFAM6642 | 743 | 811 | 66 | 42 | 2 7/8 |
| | | EVPFAM6648 | 806 | 879 | 66 | 48 | 2 7/8 |
| | | EVPFAM6654 | 896 | 978 | 66 | 54 | 2 7/8 |
| EVPFAM6660 | 983 | 1073 | 66 | 60 | 2 7/8 | | |

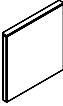
EVPLFAM - MONOLITHIC LIGHT PANEL

- Monolithic Light Panel incorporates fabric modules within a solid steel frame.
- There is no base raceway in Light Panels to accommodate electrical.
- Light Panel Connectors must be used in conjunction with Light Panels.
- Fabric covered modules are tackable and acoustical.
- Opposite sides of each panel may have a different fabric within the same grade at no upcharge.
- If different grades of fabric are used on one panel, the entire panel must be priced at highest grade.
- An aluminum low profile top cap is included.
- Stackability: Evolve Light panels can be increased in height in 6”H, 12”H, 18”H or 24”H increments. See Extension Modules for part numbers.

| | DESCRIPTION | PRODUCT CODE | LIST PRICE | | DIMENSIONS/INCHES | | |
|---|-----------------------------------|--------------|------------|-----|-------------------|----|-------|
| | | | Gr1 | Gr2 | H | W | D |
|  | Monolithic Light Panel - 42” High | EVPLFAM4218 | 349 | 378 | 42 | 18 | 2 7/8 |
| | | EVPLFAM4224 | 367 | 407 | 42 | 24 | 2 7/8 |
| | | EVPLFAM4230 | 422 | 470 | 42 | 30 | 2 7/8 |
| | | EVPLFAM4236 | 451 | 504 | 42 | 36 | 2 7/8 |
| | | EVPLFAM4242 | 501 | 561 | 42 | 42 | 2 7/8 |
| | | EVPLFAM4248 | 543 | 613 | 42 | 48 | 2 7/8 |
| | | EVPLFAM4254 | 598 | 674 | 42 | 54 | 2 7/8 |
|  | Monolithic Light Panel - 48” High | EVPLFAM4818 | 354 | 383 | 48 | 18 | 2 7/8 |
| | | EVPLFAM4824 | 385 | 423 | 48 | 24 | 2 7/8 |
| | | EVPLFAM4830 | 445 | 493 | 48 | 30 | 2 7/8 |
| | | EVPLFAM4836 | 484 | 537 | 48 | 36 | 2 7/8 |
| | | EVPLFAM4842 | 541 | 602 | 48 | 42 | 2 7/8 |
| | | EVPLFAM4848 | 588 | 656 | 48 | 48 | 2 7/8 |
| | | EVPLFAM4854 | 649 | 726 | 48 | 54 | 2 7/8 |
|  | Monolithic Light Panel - 54” High | EVPLFAM5418 | 355 | 385 | 54 | 18 | 2 7/8 |
| | | EVPLFAM5424 | 391 | 425 | 54 | 24 | 2 7/8 |
| | | EVPLFAM5430 | 454 | 501 | 54 | 30 | 2 7/8 |
| | | EVPLFAM5436 | 504 | 558 | 54 | 36 | 2 7/8 |
| | | EVPLFAM5442 | 561 | 625 | 54 | 42 | 2 7/8 |
| | | EVPLFAM5448 | 611 | 679 | 54 | 48 | 2 7/8 |
| | | EVPLFAM5454 | 671 | 748 | 54 | 54 | 2 7/8 |
|  | Monolithic Light Panel - 66” High | EVPLFAM6618 | 440 | 470 | 66 | 18 | 2 7/8 |
| | | EVPLFAM6624 | 479 | 517 | 66 | 24 | 2 7/8 |
| | | EVPLFAM6630 | 541 | 591 | 66 | 30 | 2 7/8 |
| | | EVPLFAM6636 | 629 | 684 | 66 | 36 | 2 7/8 |
| | | EVPLFAM6642 | 706 | 768 | 66 | 42 | 2 7/8 |
| | | EVPLFAM6648 | 766 | 833 | 66 | 48 | 2 7/8 |
| | | EVPLFAM6654 | 849 | 926 | 66 | 54 | 2 7/8 |
| EVPLFAM6660 | 932 | 1019 | 66 | 60 | 2 7/8 | | |



EVPBFAM - MONOLITHIC BELTLINE POWERED PANEL

- Monolithic Beltline Powered Panel incorporates fabric modules with a power beltline raceway, within a solid steel frame.
- 6”H power beltline raceway, to accommodate electrical, is metal with knockouts on both side.
- A Chimney Panel is required to run electric and data from the base to belt.
- Beltline Connectors must be used in conjunction with beltline panels.
- Fabric covered modules are tackable and acoustical.
- Opposite sides of each panel may have a different fabric within the same grade at no upcharge.
- If different grades of fabric are used on one panel, the entire panel must be priced at highest grade.
- An aluminum low profile top cap is included.
- Stackability: Evolve panels can be increased in height in 6”H, 12”H, 18”H or 24”H increments. See Extension Modules for part numbers.

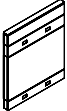
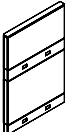
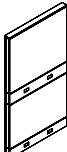
| | DESCRIPTION | PRODUCT CODE | LIST PRICE | | DIMENSIONS/INCHES | | |
|--|---|--------------|------------|------|-------------------|----|-------|
| | | | Gr1 | Gr2 | H | W | D |
|  | Monolithic Beltline Powered Panel - 42” High 24” Fabric /6” Power Belt /6” Fabric | EVPBFAM4224 | 480 | 504 | 42 | 24 | 2 7/8 |
| | | EVPBFAM4230 | 567 | 597 | 42 | 30 | 2 7/8 |
| | | EVPBFAM4236 | 646 | 679 | 42 | 36 | 2 7/8 |
| | | EVPBFAM4242 | 728 | 768 | 42 | 42 | 2 7/8 |
| | | EVPBFAM4248 | 806 | 849 | 42 | 48 | 2 7/8 |
| | | EVPBFAM4254 | 882 | 931 | 42 | 54 | 2 7/8 |
|  | Monolithic Beltline Powered Panel - 54” High 24” Fabric /6” Power Belt /18” Fabric | EVPBFAM5424 | 576 | 611 | 54 | 24 | 2 7/8 |
| | | EVPBFAM5430 | 676 | 715 | 54 | 30 | 2 7/8 |
| | | EVPBFAM5436 | 764 | 809 | 54 | 36 | 2 7/8 |
| | | EVPBFAM5442 | 857 | 910 | 54 | 42 | 2 7/8 |
| | | EVPBFAM5448 | 941 | 1006 | 54 | 48 | 2 7/8 |
| | | EVPBFAM5454 | 1033 | 1103 | 54 | 54 | 2 7/8 |
|  | Monolithic Beltline Powered Panel - 66” High 24” Fabric /6” Power Belt /30” Fabric | EVPBFAM6624 | 682 | 744 | 66 | 24 | 2 7/8 |
| | | EVPBFAM6630 | 796 | 867 | 66 | 30 | 2 7/8 |
| | | EVPBFAM6636 | 900 | 982 | 66 | 36 | 2 7/8 |
| | | EVPBFAM6642 | 1014 | 1110 | 66 | 42 | 2 7/8 |
| | | EVPBFAM6648 | 1119 | 1227 | 66 | 48 | 2 7/8 |
| | | EVPBFAM6654 | 1227 | 1347 | 66 | 54 | 2 7/8 |
| | | EVPBFAM6660 | 1335 | 1468 | 66 | 60 | 2 7/8 |

EVPBLFAM - MONOLITHIC BELTLINE POWERED LIGHT PANEL

- Monolithic Beltline Powered Light Panel incorporates fabric modules with a power beltline raceway within a solid steel frame
- 6”H power beltline raceway, to accommodate electrical, is metal with knockouts on both sides.
- There is no base raceway in Light Panels to accommodate electrical
- Light Beltline Panel Connectors must be used in conjunction with Light Beltline Panels.
- Fabric covered modules are tackable and acoustical.
- Opposite sides of each panel may have a different fabric within the same grade at no upcharge.
- If different grades of fabric are used on one panel, the entire panel must be priced at highest grade.
- An aluminum low profile top cap is included.
- Stackability: Evolve Light panels can be increased in height in 6”H, 12”H, 18”H or 24”H increments. See Extension Modules for part numbers.

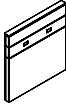
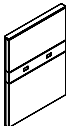
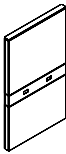
| | DESCRIPTION | PRODUCT CODE | LIST PRICE | | DIMENSIONS/INCHES | | |
|--|--|--------------|------------|------|-------------------|----|-------|
| | | | Gr1 | Gr2 | H | W | D |
|  | Monolithic Beltline Powered Light Panel - 42” High | EVPBLFAM4224 | 456 | 480 | 42 | 24 | 2 7/8 |
| | | EVPBLFAM4230 | 539 | 567 | 42 | 30 | 2 7/8 |
| | 24” Fabric /6” Power Belt /6” Fabric | EVPBLFAM4236 | 613 | 648 | 42 | 36 | 2 7/8 |
| | | EVPBLFAM4242 | 690 | 730 | 42 | 42 | 2 7/8 |
| | | EVPBLFAM4248 | 766 | 808 | 42 | 48 | 2 7/8 |
| | | EVPBLFAM4254 | 839 | 888 | 42 | 54 | 2 7/8 |
| | | EVPBLFAM4260 | 912 | 968 | 42 | 60 | 2 7/8 |
|  | Monolithic Beltline Powered Light Panel - 54” High | EVPBLFAM5424 | 531 | 564 | 54 | 24 | 2 7/8 |
| | | EVPBLFAM5430 | 622 | 664 | 54 | 30 | 2 7/8 |
| | 24” Fabric /6” Power Belt /18” Fabric | EVPBLFAM5436 | 702 | 747 | 54 | 36 | 2 7/8 |
| | | EVPBLFAM5442 | 785 | 840 | 54 | 42 | 2 7/8 |
| | | EVPBLFAM5448 | 867 | 929 | 54 | 48 | 2 7/8 |
| | | EVPBLFAM5454 | 952 | 1020 | 54 | 54 | 2 7/8 |
| | | EVPBLFAM5460 | 1029 | 1105 | 54 | 60 | 2 7/8 |
|  | Monolithic Beltline Powered Light Panel - 66” High | EVPBLFAM6624 | 634 | 696 | 66 | 24 | 2 7/8 |
| | | EVPBLFAM6630 | 737 | 810 | 66 | 30 | 2 7/8 |
| | 24” Fabric /6” Power Belt /30” Fabric | EVPBLFAM6636 | 835 | 920 | 66 | 36 | 2 7/8 |
| | | EVPBLFAM6642 | 941 | 1038 | 66 | 42 | 2 7/8 |
| | | EVPBLFAM6648 | 1040 | 1151 | 66 | 48 | 2 7/8 |
| | | EVPBLFAM6654 | 1141 | 1260 | 66 | 54 | 2 7/8 |
| | | EVPBLFAM6660 | 1241 | 1374 | 66 | 60 | 2 7/8 |



EVPBCFAM - MONOLITHIC BELTLINE POWERED CHIMNEY PANEL

- Monolithic Chimney Beltline Powered Panel incorporates fabric modules with a power beltline raceway within a solid steel frame.
- A Chimney Panel is required to run electric and data from the base to belt.
- Separate electric harness required to go from base to belt (see EVE8CPCP).
- 6”H power beltline raceway, to accommodate electrical, is metal with knockouts on both sides.
- Beltline Connectors must be used in conjunction with beltline panels.
- Fabric covered modules are tackable and acoustical.
- Opposite sides of each panel may have a different fabric within the same grade at no upcharge.
- If different grades of fabric are used on one panel, the entire panel must be priced at highest grade.
- An aluminum low profile top cap is included.
- Stackability: Evolve panels can be increased in height in 6”H, 12”H, 18”H or 24”H increments. See Extension Module listings for part numbers

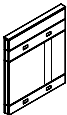
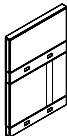
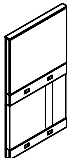
| | DESCRIPTION | PRODUCT CODE | LIST PRICE | | DIMENSIONS/INCHES | | |
|---|---|--------------|------------|------|-------------------|----|-------|
| | | | Gr1 | Gr2 | H | W | D |
|  | Monolithic Beltline Powered Chimney Panel - 42” High 24” Fabric Chimney /6” Power Belt /6” Fabric | EVPBCFAM4236 | 726 | 764 | 42 | 36 | 2 7/8 |
| | | EVPBCFAM4242 | 808 | 847 | 42 | 42 | 2 7/8 |
|  | Monolithic Beltline Powered Chimney Panel - 54” High 24” Fabric Chimney /6” Power Belt /18” Fabric | EVPBCFAM5436 | 840 | 888 | 54 | 36 | 2 7/8 |
| | | EVPBCFAM5442 | 935 | 988 | 54 | 42 | 2 7/8 |
|  | Monolithic Beltline Powered Chimney Panel - 66” High 24” Fabric Chimney /6” Power Belt /30” Fabric | EVPBCFAM6636 | 978 | 1062 | 66 | 36 | 2 7/8 |
| | | EVPBCFAM6642 | 1093 | 1190 | 66 | 42 | 2 7/8 |

EVE8CPCP - CHIMNEY PANEL JUMPER CABLE KIT

- Contains two (2) 17” flexible harnesses and one (1) “I” connector.
- Used to connect electric from the base to the beltline raceway in Beltline Powered Chimney panel.
- Must use in conjunction with base power distribution harness and beltline power distribution harness (sold separately)

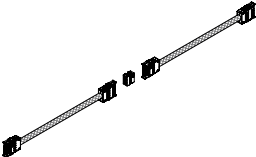
| | DESCRIPTION | PRODUCT CODE | LIST PRICE | DIMENSIONS/INCHES | | |
|---|--------------------------------|--------------|------------|-------------------|---|---|
| | | | | H | W | D |
|  | Chimney Panel Jumper Cable Kit | EVE8CPCP | 341 | | | |

EVPBFFAM - MONOLITHIC BELTLINE NON-POWERED PANEL

- Monolithic Beltline Non-Powered Panel incorporates fabric modules within a solid steel frame.
- Electrical cannot pass through panel at the beltline level.
- Fabric covered modules are tackable and acoustical.
- Opposite sides of each panel may have a different fabric within the same grade at no upcharge.
- If different grades of fabric are used on one panel, the entire panel must be priced at highest grade.
- An aluminum low profile top cap is included.
- Stackability: Evolve panels can be increased in height in 6”H, 12”H, 18”H or 24”H increments. See Extension Modules for part numbers.

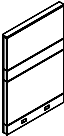
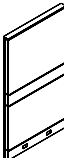
| | DESCRIPTION | PRODUCT CODE | LIST PRICE | | DIMENSIONS/INCHES | | |
|---|--|--------------|------------|------|-------------------|----|-------|
| | | | Gr1 | Gr2 | H | W | D |
|  | Monolithic Beltline Non-Powered Panel - 54” High | EVPBFFAM5424 | 576 | 615 | 54 | 24 | 2 7/8 |
| | 24” Fabric /6” Fabric /18” Fabric | EVPBFFAM5430 | 676 | 721 | 54 | 30 | 2 7/8 |
| | | EVPBFFAM5436 | 764 | 814 | 54 | 36 | 2 7/8 |
| | | EVPBFFAM5442 | 857 | 919 | 54 | 42 | 2 7/8 |
| | | EVPBFFAM5448 | 941 | 1014 | 54 | 48 | 2 7/8 |
| | | EVPBFFAM5454 | 1033 | 1113 | 54 | 54 | 2 7/8 |
| | | EVPBFFAM5460 | 1120 | 1209 | 54 | 60 | 2 7/8 |
|  | Monolithic Beltline Non-Powered Panel - 66” High | EVPBFFAM6624 | 682 | 746 | 66 | 24 | 2 7/8 |
| | 24” Fabric /6” Fabric /30” Fabric | EVPBFFAM6630 | 796 | 871 | 66 | 30 | 2 7/8 |
| | | EVPBFFAM6636 | 900 | 987 | 66 | 36 | 2 7/8 |
| | | EVPBFFAM6642 | 1014 | 1118 | 66 | 42 | 2 7/8 |
| | | EVPBFFAM6648 | 1119 | 1235 | 66 | 48 | 2 7/8 |
| | | EVPBFFAM6654 | 1227 | 1356 | 66 | 54 | 2 7/8 |
| | | EVPBFFAM6660 | 1335 | 1479 | 66 | 60 | 2 7/8 |

EVPBLFFAM - MONOLITHIC BELTLINE NON-POWERED LIGHT PANEL

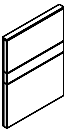
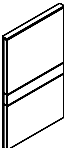

- Monolithic Beltline Non-Powered Light Panel incorporates all fabric modules within a solid steel frame.
- There is no base raceway in Light Panels to accommodate electrical.
- Electrical cannot pass through panel at the beltline level.
- Fabric covered modules are tackable and acoustical.
- Opposite sides of each panel may have a different fabric within the same grade at no upcharge.
- If different grades of fabric are used on one panel, the entire panel must be priced at highest grade.
- An aluminum low profile top cap is included.
- Stackability: Evolve panels can be increased in height in 6”H, 12”H, 18”H or 24”H increments. See Extension Modules for part numbers.

| | DESCRIPTION | PRODUCT CODE | LIST PRICE | | DIMENSIONS/INCHES | | |
|---|--|---------------|------------|------|-------------------|----|-------|
| | | | Gr1 | Gr2 | H | W | D |
|  | Monolithic Beltline Non-Powered Light Panel - 54” High | EVPBLFFAM5424 | 531 | 570 | 54 | 24 | 2 7/8 |
| | 24” Fabric /6” Fabric /18” Fabric | EVPBLFFAM5430 | 625 | 673 | 54 | 30 | 2 7/8 |
| | | EVPBLFFAM5436 | 702 | 753 | 54 | 36 | 2 7/8 |
| | | EVPBLFFAM5442 | 785 | 849 | 54 | 42 | 2 7/8 |
| | | EVPBLFFAM5448 | 867 | 938 | 54 | 48 | 2 7/8 |
| | | EVPBLFFAM5454 | 952 | 1029 | 54 | 54 | 2 7/8 |
| | | EVPBLFFAM5460 | 1029 | 1118 | 54 | 60 | 2 7/8 |
|  | Monolithic Beltline Non-Powered Light Panel - 66” High | EVPBLFFAM6624 | 634 | 699 | 66 | 24 | 2 7/8 |
| | 24” Fabric /6” Fabric /30” Fabric | EVPBLFFAM6630 | 737 | 814 | 66 | 30 | 2 7/8 |
| | | EVPBLFFAM6636 | 835 | 926 | 66 | 36 | 2 7/8 |
| | | EVPBLFFAM6642 | 941 | 1048 | 66 | 42 | 2 7/8 |
| | | EVPBLFFAM6648 | 1040 | 1158 | 66 | 48 | 2 7/8 |
| | | EVPBLFFAM6654 | 1141 | 1270 | 66 | 54 | 2 7/8 |
| | | EVPBLFFAM6660 | 1241 | 1384 | 66 | 60 | 2 7/8 |



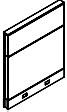
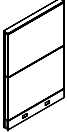
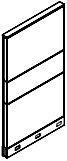

EVPFA - SEGMENTED PANEL

- Segmented Panel incorporates fabric modules within a solid steel frame.
- Fabric covered modules are tackable and acoustical.
- Opposite sides of each panel may have a different fabric within the same grade at no upcharge.
- If different grades of fabric are used on one panel, the entire panel must be priced at highest grade.
- An aluminum low profile top cap is included.
- Stackability: Evolve panels can be increased in height in 6”H, 12”H, 18”H or 24”H increments. See Extension Modules or part numbers.

| | DESCRIPTION | PRODUCT CODE | LIST PRICE | | DIMENSIONS/INCHES | | |
|---|----------------------------|--------------|------------|------|-------------------|----|-------|
| | | | Gr1 | Gr2 | H | W | D |
|  | Segmented Panel - 30" High | EVPPFA3018 | 355 | 370 | 30 | 18 | 2 7/8 |
| | | EVPPFA3024 | 367 | 392 | 30 | 24 | 2 7/8 |
| | | EVPPFA3030 | 411 | 435 | 30 | 30 | 2 7/8 |
| | | EVPPFA3036 | 444 | 471 | 30 | 36 | 2 7/8 |
| | | EVPPFA3042 | 475 | 508 | 30 | 42 | 2 7/8 |
| | | EVPPFA3048 | 524 | 560 | 30 | 48 | 2 7/8 |
| | | EVPPFA3054 | 566 | 607 | 30 | 54 | 2 7/8 |
| | | EVPPFA3060 | 607 | 654 | 30 | 60 | 2 7/8 |
|  | Segmented Panel - 42" High | EVPPFA4218 | 392 | 417 | 42 | 18 | 2 7/8 |
| | | EVPPFA4224 | 415 | 446 | 42 | 24 | 2 7/8 |
| | | EVPPFA4230 | 481 | 517 | 42 | 30 | 2 7/8 |
| | | EVPPFA4236 | 515 | 559 | 42 | 36 | 2 7/8 |
| | | EVPPFA4242 | 591 | 638 | 42 | 42 | 2 7/8 |
| | | EVPPFA4248 | 634 | 689 | 42 | 48 | 2 7/8 |
| | | EVPPFA4254 | 703 | 765 | 42 | 54 | 2 7/8 |
| | | EVPPFA4260 | 770 | 836 | 42 | 60 | 2 7/8 |
|  | Segmented Panel - 54" High | EVPPFA5418 | 421 | 454 | 54 | 18 | 2 7/8 |
| | | EVPPFA5424 | 459 | 500 | 54 | 24 | 2 7/8 |
| | | EVPPFA5430 | 525 | 574 | 54 | 30 | 2 7/8 |
| | | EVPPFA5436 | 587 | 644 | 54 | 36 | 2 7/8 |
| | | EVPPFA5442 | 664 | 728 | 54 | 42 | 2 7/8 |
| | | EVPPFA5448 | 736 | 810 | 54 | 48 | 2 7/8 |
| | | EVPPFA5454 | 799 | 876 | 54 | 54 | 2 7/8 |
| | | EVPPFA5460 | 858 | 943 | 54 | 60 | 2 7/8 |
|  | Segmented Panel - 66" High | EVPPFA6618 | 531 | 570 | 66 | 18 | 2 7/8 |
| | | EVPPFA6624 | 570 | 621 | 66 | 24 | 2 7/8 |
| | | EVPPFA6630 | 632 | 690 | 66 | 30 | 2 7/8 |
| | | EVPPFA6636 | 739 | 812 | 66 | 36 | 2 7/8 |
| | | EVPPFA6642 | 833 | 914 | 66 | 42 | 2 7/8 |
| | | EVPPFA6648 | 896 | 986 | 66 | 48 | 2 7/8 |
| | | EVPPFA6654 | 971 | 1070 | 66 | 54 | 2 7/8 |
| | | EVPPFA6660 | 1052 | 1161 | 66 | 60 | 2 7/8 |
|  | Segmented Panel - 66" High | EVPPFA6618S | 531 | 570 | 66 | 18 | 2 7/8 |
| | | EVPPFA6624S | 570 | 621 | 66 | 24 | 2 7/8 |
| | | EVPPFA6630S | 632 | 690 | 66 | 30 | 2 7/8 |
| | | EVPPFA6636S | 739 | 812 | 66 | 36 | 2 7/8 |
| | | EVPPFA6642S | 833 | 914 | 66 | 42 | 2 7/8 |
| | | EVPPFA6648S | 896 | 986 | 66 | 48 | 2 7/8 |
| | | EVPPFA6654S | 971 | 1070 | 66 | 54 | 2 7/8 |
| | | EVPPFA6660S | 1052 | 1161 | 66 | 60 | 2 7/8 |

EVPLFA - SEGMENTED LIGHT PANEL

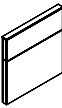
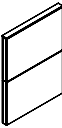

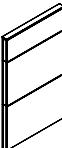
- Segmented Light Panel incorporates fabric modules within a solid steel frame.
- There is no base raceway in Light Panels to accommodate electrical.
- Light Panel Connectors must be used in conjunction with Light Panels.
- Fabric covered modules are tackable and acoustical.
- Opposite sides of each panel may have a different fabric within the same grade at no upcharge.
- If different grades of fabric are used on one panel, the entire panel must be priced at highest grade.
- An aluminum low profile top cap is included.
- Stackability: Evolve Light panels can be increased in height in 6”H, 12”H, 18”H or 24”H increments. See Extension Modules for part numbers.

| | DESCRIPTION | PRODUCT CODE | LIST PRICE | | DIMENSIONS/INCHES | | |
|---|----------------------------------|--------------|------------|------|-------------------|----|-------|
| | | | Gr1 | Gr2 | H | W | D |
|  | Segmented Light Panel - 30" High | EVPLFA3018 | 337 | 352 | 30 | 18 | 2 7/8 |
| | | EVPLFA3024 | 352 | 367 | 30 | 24 | 2 7/8 |
| | | EVPLFA3030 | 391 | 412 | 30 | 30 | 2 7/8 |
| | | EVPLFA3036 | 421 | 445 | 30 | 36 | 2 7/8 |
| | | EVPLFA3042 | 451 | 480 | 30 | 42 | 2 7/8 |
| | | EVPLFA3048 | 499 | 533 | 30 | 48 | 2 7/8 |
| | | EVPLFA3054 | 537 | 574 | 30 | 54 | 2 7/8 |
|  | Segmented Light Panel - 42" High | EVPLFA4218 | 371 | 393 | 42 | 18 | 2 7/8 |
| | | EVPLFA4224 | 394 | 421 | 42 | 24 | 2 7/8 |
| | | EVPLFA4230 | 457 | 493 | 42 | 30 | 2 7/8 |
| | | EVPLFA4236 | 493 | 531 | 42 | 36 | 2 7/8 |
| | | EVPLFA4242 | 560 | 602 | 42 | 42 | 2 7/8 |
| | | EVPLFA4248 | 602 | 655 | 42 | 48 | 2 7/8 |
| | | EVPLFA4254 | 667 | 721 | 42 | 54 | 2 7/8 |
|  | Segmented Light Panel - 54" High | EVPLFA5418 | 400 | 429 | 54 | 18 | 2 7/8 |
| | | EVPLFA5424 | 439 | 472 | 54 | 24 | 2 7/8 |
| | | EVPLFA5430 | 501 | 543 | 54 | 30 | 2 7/8 |
| | | EVPLFA5436 | 557 | 607 | 54 | 36 | 2 7/8 |
| | | EVPLFA5442 | 629 | 687 | 54 | 42 | 2 7/8 |
| | | EVPLFA5448 | 702 | 768 | 54 | 48 | 2 7/8 |
| | | EVPLFA5454 | 761 | 831 | 54 | 54 | 2 7/8 |
|  | Segmented Light Panel - 66" High | EVPLFA6618 | 504 | 539 | 66 | 18 | 2 7/8 |
| | | EVPLFA6624 | 539 | 588 | 66 | 24 | 2 7/8 |
| | | EVPLFA6630 | 600 | 655 | 66 | 30 | 2 7/8 |
| | | EVPLFA6636 | 704 | 769 | 66 | 36 | 2 7/8 |
| | | EVPLFA6642 | 794 | 866 | 66 | 42 | 2 7/8 |
| | | EVPLFA6648 | 849 | 931 | 66 | 48 | 2 7/8 |
| | | EVPLFA6654 | 922 | 1017 | 66 | 54 | 2 7/8 |
|  | Segmented Light Panel - 66" High | EVPLFA6618S | 504 | 539 | 66 | 18 | 2 7/8 |
| | | EVPLFA6624S | 539 | 588 | 66 | 24 | 2 7/8 |
| | | EVPLFA6630S | 600 | 655 | 66 | 30 | 2 7/8 |
| | | EVPLFA6636S | 704 | 769 | 66 | 36 | 2 7/8 |
| | | EVPLFA6642S | 794 | 866 | 66 | 42 | 2 7/8 |
| | | EVPLFA6648S | 849 | 931 | 66 | 48 | 2 7/8 |
| | | EVPLFA6654S | 922 | 1017 | 66 | 54 | 2 7/8 |
| EVPLFA6660S | 1000 | 1102 | 66 | 60 | 2 7/8 | | |

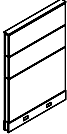

EVFPF - SEGMENTED PREMIUM PANEL

- Segmented Premium Panel incorporates fabric modules within a solid steel frame.
- Segmented Premium panels incorporate 12" H acoustic modules above 24" base module , plus 6" H base raceway.
- Fabric covered modules are tackable and acoustical.
- Opposite sides of each panel may have a different fabric within the same grade at no upcharge.
- If different grades of fabric are used on one panel, the entire panel must be priced at highest grade.
- An aluminum low profile top cap is included.
- Stackability: Evolve panels can be increased in height in 6"H, 12"H, 18"H or 24"H increments. See Extension Modules for part numbers.

| | DESCRIPTION | PRODUCT CODE | LIST PRICE | | DIMENSIONS/INCHES | | |
|---|------------------------------------|--------------|------------|------|-------------------|----|-------|
| | | | Gr1 | Gr2 | H | W | D |
|  | Segmented Premium Panel - 54" High | EVFPF5418 | 494 | 525 | 54 | 18 | 2 7/8 |
| | | EVFPF5424 | 524 | 563 | 54 | 24 | 2 7/8 |
| | | EVFPF5430 | 577 | 625 | 54 | 30 | 2 7/8 |
| | | EVFPF5436 | 679 | 734 | 54 | 36 | 2 7/8 |
| | | EVFPF5442 | 768 | 832 | 54 | 42 | 2 7/8 |
| | | EVFPF5448 | 821 | 891 | 54 | 48 | 2 7/8 |
| | | EVFPF5454 | 871 | 955 | 54 | 54 | 2 7/8 |
| | | EVFPF5460 | 921 | 1009 | 54 | 60 | 2 7/8 |
|  | Segmented Premium Panel - 66" High | EVFPF6618 | 621 | 659 | 66 | 18 | 2 7/8 |
| | | EVFPF6624 | 646 | 695 | 66 | 24 | 2 7/8 |
| | | EVFPF6630 | 703 | 765 | 66 | 30 | 2 7/8 |
| | | EVFPF6636 | 744 | 817 | 66 | 36 | 2 7/8 |
| | | EVFPF6642 | 886 | 967 | 66 | 42 | 2 7/8 |
| | | EVFPF6648 | 970 | 1061 | 66 | 48 | 2 7/8 |
| | | EVFPF6654 | 1033 | 1130 | 66 | 54 | 2 7/8 |
| | | EVFPF6660 | 1098 | 1208 | 66 | 60 | 2 7/8 |

EVPLFP - SEGMENTED LIGHT PANEL - PREMIUM

- Segmented Premium Light Panel incorporates fabric modules within a solid steel frame.
- Segmented Premium panels incorporate 12" H acoustic modules above 24" base module , plus 6" H open base.
- There is no base raceway in Light Panels to accommodate electrical.
- Light Panel Connectors must be used in conjunction with Light Panels.
- Fabric covered modules are tackable and acoustical.
- Opposite sides of each panel may have a different fabric within the same grade at no upcharge.
- If different grades of fabric are used on one panel, the entire panel must be priced at highest grade.
- An aluminum low profile top cap is included.
- Stackability: Evolve Light panels can be increased in height in 6"H, 12"H, 18"H or 24"H increments. See Extension Modules for part numbers.

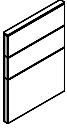
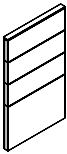
| | DESCRIPTION | PRODUCT CODE | LIST PRICE | | DIMENSIONS/INCHES | | |
|---|--|--------------|------------|------|-------------------|----|-------|
| | | | Gr1 | Gr2 | H | W | D |
|  | Segmented Premium Light Panel - Premium - 54" High | EVPLFP5418 | 470 | 499 | 54 | 18 | 2 7/8 |
| | | EVPLFP5424 | 499 | 535 | 54 | 24 | 2 7/8 |
| | | EVPLFP5430 | 548 | 593 | 54 | 30 | 2 7/8 |
| | | EVPLFP5436 | 647 | 697 | 54 | 36 | 2 7/8 |
| | | EVPLFP5442 | 730 | 788 | 54 | 42 | 2 7/8 |
| | | EVPLFP5448 | 779 | 845 | 54 | 48 | 2 7/8 |
| | | EVPLFP5454 | 829 | 902 | 54 | 54 | 2 7/8 |
| | | EVPLFP5460 | 874 | 959 | 54 | 60 | 2 7/8 |
|  | Segmented Premium Light Panel - Premium - 66" High | EVPLFP6618 | 591 | 625 | 66 | 18 | 2 7/8 |
| | | EVPLFP6624 | 613 | 657 | 66 | 24 | 2 7/8 |
| | | EVPLFP6630 | 667 | 721 | 66 | 30 | 2 7/8 |
| | | EVPLFP6636 | 707 | 774 | 66 | 36 | 2 7/8 |
| | | EVPLFP6642 | 840 | 918 | 66 | 42 | 2 7/8 |
| | | EVPLFP6648 | 921 | 1006 | 66 | 48 | 2 7/8 |
| | | EVPLFP6654 | 982 | 1073 | 66 | 54 | 2 7/8 |
| | | EVPLFP6660 | 1042 | 1146 | 66 | 60 | 2 1/4 |

EVPBFA - SEGMENTED BELTLINE POWERED PANEL

- Segmented Beltline Powered Panel incorporates fabric modules with a power beltline raceway, within a solid steel frame.
- A Chimney Panel is required to run electric and data from the base to belt.
- 6”H power beltline raceway, to accommodate electrical, is metal with knockouts on both sides.
- Beltline connectors must be used in conjunction with beltline panels.
- Fabric covered modules are tackable and acoustical.
- Opposite sides of each panel may have a different fabric within the same grade at no upcharge.
- If different grades of fabric are used on one panel, the entire panel must be priced at highest grade.
- An aluminum low profile top cap is included.
- Stackability: Evolve panels can be increased in height in 6”H, 12”H, 18”H or 24”H increments. See Extension Modules for part numbers.

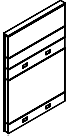
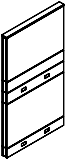
| | DESCRIPTION | PRODUCT CODE | LIST PRICE | | DIMENSIONS/INCHES | | |
|---|--|--------------|------------|------|-------------------|----|-------|
| | | | Gr1 | Gr2 | H | W | D |
|  | Segmented Beltline Powered Panel - 54” High 24” Fabric /6” Power /6” Fabric /12” Fabric | EVPBFA5424 | 575 | 608 | 54 | 24 | 2 7/8 |
| | | EVPBFA5430 | 674 | 713 | 54 | 30 | 2 7/8 |
| | | EVPBFA5436 | 775 | 824 | 54 | 36 | 2 7/8 |
| | | EVPBFA5442 | 869 | 923 | 54 | 42 | 2 7/8 |
| | | EVPBFA5448 | 951 | 1014 | 54 | 48 | 2 7/8 |
| | | EVPBFA5454 | 1042 | 1113 | 54 | 54 | 2 7/8 |
| | | EVPBFA5460 | 1136 | 1213 | 54 | 60 | 2 7/8 |
|  | Segmented Beltline Powered Panel - 66” High 24” Fabric /6” Power /6” Fabric /24” Fabric | EVPBFA6624 | 687 | 733 | 66 | 24 | 2 7/8 |
| | | EVPBFA6630 | 806 | 857 | 66 | 30 | 2 7/8 |
| | | EVPBFA6636 | 912 | 976 | 66 | 36 | 2 7/8 |
| | | EVPBFA6642 | 1027 | 1098 | 66 | 42 | 2 7/8 |
| | | EVPBFA6648 | 1135 | 1214 | 66 | 48 | 2 7/8 |
| | | EVPBFA6654 | 1246 | 1334 | 66 | 54 | 2 7/8 |
| | | EVPBFA6660 | 1355 | 1450 | 66 | 60 | 2 7/8 |

EVPBLFA - SEGMENTED BELTLINE POWERED LIGHT PANEL

- Segmented Beltline Powered Light Panel incorporates fabric modules with a power beltline raceway, within a solid steel frame.
- There is no base raceway in Light Panels to accommodate electrical.
- 6”H power beltline raceway, to accommodate electrical, is metal with knockouts on both sides.
- Beltline Light Panel Connectors must be used in conjunction with Beltline Light Panels.
- Fabric covered modules are tackable and acoustical.
- Opposite sides of each panel may have a different fabric within the same grade at no upcharge.
- If different grades of fabric are used on one panel, the entire panel must be priced at highest grade.
- An aluminum low profile top cap is included.
- Stackability: Evolve Light panels can be increased in height in 6”H, 12”H, 18”H or 24”H increments. See Extension Modules for part numbers.

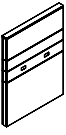
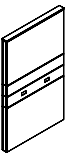
| | DESCRIPTION | PRODUCT CODE | LIST PRICE | | DIMENSIONS/INCHES | | |
|---|--|--------------|------------|------|-------------------|----|-------|
| | | | Gr1 | Gr2 | H | W | D |
|  | Segmented Beltline Powered Light Panel - 54” High 24” Fabric /6” Power /6” Fabric /12” Fabric | EVPBLFA5424 | 528 | 561 | 54 | 24 | 2 7/8 |
| | | EVPBLFA5430 | 618 | 657 | 54 | 30 | 2 7/8 |
| | | EVPBLFA5436 | 714 | 765 | 54 | 36 | 2 7/8 |
| | | EVPBLFA5442 | 801 | 857 | 54 | 42 | 2 7/8 |
| | | EVPBLFA5448 | 874 | 938 | 54 | 48 | 2 7/8 |
| | | EVPBLFA5454 | 960 | 1028 | 54 | 54 | 2 7/8 |
| | | EVPBLFA5460 | 1048 | 1121 | 54 | 60 | 2 7/8 |
|  | Segmented Beltline Powered Light Panel - 66” High 24” Fabric /6” Power /6” Fabric /24 Fabric | EVPBLFA6624 | 634 | 677 | 66 | 24 | 2 7/8 |
| | | EVPBLFA6630 | 739 | 794 | 66 | 30 | 2 7/8 |
| | | EVPBLFA6636 | 840 | 905 | 66 | 36 | 2 7/8 |
| | | EVPBLFA6642 | 946 | 1017 | 66 | 42 | 2 7/8 |
| | | EVPBLFA6648 | 1042 | 1121 | 66 | 48 | 2 7/8 |
| | | EVPBLFA6654 | 1146 | 1234 | 66 | 54 | 2 7/8 |
| | | EVPBLFA6660 | 1247 | 1345 | 66 | 60 | 2 7/8 |



EVPBCFA - SEGMENTED BELTLINE POWERED CHIMNEY PANEL

- Segmented Chimney Beltline Powered Panel incorporates fabric modules with a power beltline raceway, within a solid steel frame.
- A Chimney Panel is required to run electric and data from the base to belt.
- Separate electric harness required to go from base to belt (see EVE8CPCP).
- 6”H power beltline raceway, to accommodate electrical, is metal with knockouts on both sides.
- Beltline Connectors must be used in conjunction with beltline panels.
- Fabric covered modules are tackable and acoustical.
- Opposite sides of each panel may have a different fabric within the same grade at no upcharge.
- If different grades of fabric are used on one panel, the entire panel must be priced at highest grade.
- An aluminum low profile top cap is included.
- Stackability: Evolve panels can be increased in height in 6”H, 12”H, 18”H or 24”H increments. See Extension Modules for part numbers.

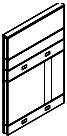
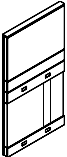
| | DESCRIPTION | PRODUCT CODE | LIST PRICE | | DIMENSIONS/INCHES | | |
|---|---|--------------|------------|------|-------------------|----|-------|
| | | | Gr1 | Gr2 | H | W | D |
|  | Segmented Beltline Powered Chimney Panel - 54” High 24” Fabric Chimney /6” Power / 6” Fabric /12” Fabric | EVPBCFA5436 | 857 | 905 | 54 | 36 | 2 7/8 |
| | | EVPBCFA5442 | 951 | 1006 | 54 | 42 | 2 7/8 |
|  | Segmented Beltline Powered Chimney Panel - 66” High 24” Fabric Chimney /6” Power / 6” Fabric /24” Fabric | EVPBCFA6636 | 992 | 1058 | 66 | 36 | 2 7/8 |
| | | EVPBCFA6642 | 1107 | 1179 | 66 | 42 | 2 7/8 |

EVE8CPCP - CHIMNEY PANEL JUMPER CABLE KIT

- Contains two (2) 17” flexible harnesses and one (1) “I” connector.
- Used to connect electric from the base to the beltline raceway in Beltline Powered Chimney panel.
- Must use in conjunction with base power distribution harness and beltline power distribution harness (sold separately)

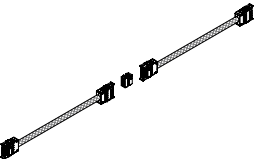
| | DESCRIPTION | PRODUCT CODE | LIST PRICE | DIMENSIONS/INCHES | | |
|---|--------------------------------|--------------|------------|-------------------|---|---|
| | | | | H | W | D |
|  | Chimney Panel Jumper Cable Kit | EVE8CPCP | 341 | | | |

EVPBFFA - SEGMENTED BELTLINE NON-POWERED PANEL

- Double Beltline Non-Powered Panel incorporates all fabric modules within a solid steel frame.
- Electrical cannot pass through panel at the beltline level.
- Fabric covered modules are tackable and acoustical.
- Opposite sides of each panel may have a different fabric within the same grade at no upcharge.
- If different grades of fabric are used on one panel, the entire panel must be priced at highest grade.
- An aluminum low profile top cap is included.
- Stackability: Evolve panels can be increased in height in 6”H, 12”H, 18”H or 24”H increments. See Extension Modules for part numbers.

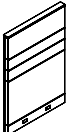
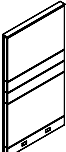
| | DESCRIPTION | PRODUCT CODE | LIST PRICE | | DIMENSIONS/INCHES | | |
|---|---|--------------|------------|------|-------------------|----|-------|
| | | | Gr1 | Gr2 | H | W | D |
|  | Segmented Beltline Non-Powered Panel - 54” High | EVPBFFA5424 | 555 | 587 | 54 | 24 | 2 7/8 |
| | | EVPBFFA5430 | 607 | 653 | 54 | 30 | 2 7/8 |
| | 24” Fabric /6” Fabric /6” Fabric /12” Fabric | EVPBFFA5436 | 714 | 769 | 54 | 36 | 2 7/8 |
| | | EVPBFFA5442 | 806 | 867 | 54 | 42 | 2 7/8 |
| | | EVPBFFA5448 | 864 | 931 | 54 | 48 | 2 7/8 |
| | | EVPBFFA5454 | 911 | 988 | 54 | 54 | 2 7/8 |
| | | EVPBFFA5460 | 956 | 1041 | 54 | 60 | 2 7/8 |
|  | Segmented Beltline Non-Powered Panel - 66” High | EVPBFFA6624 | 601 | 648 | 66 | 24 | 2 7/8 |
| | | EVPBFFA6630 | 706 | 765 | 66 | 30 | 2 7/8 |
| | 24” Fabric /6” Fabric /6” Fabric /24” Fabric | EVPBFFA6636 | 814 | 882 | 66 | 36 | 2 7/8 |
| | | EVPBFFA6642 | 916 | 992 | 66 | 42 | 2 7/8 |
| | | EVPBFFA6648 | 1001 | 1088 | 66 | 48 | 2 7/8 |
| | | EVPBFFA6654 | 1100 | 1195 | 66 | 54 | 2 7/8 |
| | | EVPBFFA6660 | 1196 | 1307 | 66 | 60 | 2 7/8 |

EVPBLFFA - SEGMENTED BELTLINE NON-POWERED LIGHT PANEL

- Double Beltline Non-Powered Panel incorporates all fabric modules within a solid steel frame.
- Electrical cannot pass through panel at the beltline level.
- There is no base raceway in Light Panels to accommodate electrical
- Fabric covered modules are tackable and acoustical.
- Opposite sides of each panel may have a different fabric within the same grade at no upcharge.
- If different grades of fabric are used on one panel, the entire panel must be priced at highest grade.
- An aluminum low profile top cap is included.
- Stackability: Evolve panels can be increased in height in 6”H, 12”H, 18”H or 24”H increments.
- See Extension Modules for part numbers.

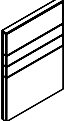
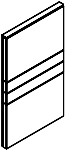
| | DESCRIPTION | PRODUCT CODE | LIST PRICE | | DIMENSIONS/INCHES | | |
|---|---|--------------|------------|------|-------------------|----|-------|
| | | | Gr1 | Gr2 | H | W | D |
|  | Segmented Beltline Non-Powered Light Panel - 54” High | EVPBLFFA5424 | 457 | 497 | 54 | 24 | 2 7/8 |
| | | EVPBLFFA5430 | 539 | 583 | 54 | 30 | 2 7/8 |
| | 24” Fabric /6” Fabric /6” Fabric /12” Fabric | EVPBLFFA5436 | 612 | 667 | 54 | 36 | 2 7/8 |
| | | EVPBLFFA5442 | 685 | 747 | 54 | 42 | 2 7/8 |
| | | EVPBLFFA5448 | 761 | 829 | 54 | 48 | 2 7/8 |
| | | EVPBLFFA5454 | 866 | 942 | 54 | 54 | 2 7/8 |
| | | EVPBLFFA5460 | 908 | 992 | 54 | 60 | 2 7/8 |
|  | Segmented Beltline Non-Powered Light Panel - 66” High | EVPBLFFA6624 | 570 | 616 | 66 | 24 | 2 7/8 |
| | | EVPBLFFA6630 | 632 | 687 | 66 | 30 | 2 7/8 |
| | 24” Fabric /6” Fabric /6” Fabric /24” Fabric | EVPBLFFA6636 | 739 | 808 | 66 | 36 | 2 7/8 |
| | | EVPBLFFA6642 | 833 | 911 | 66 | 42 | 2 7/8 |
| | | EVPBLFFA6648 | 896 | 982 | 66 | 48 | 2 7/8 |
| | | EVPBLFFA6654 | 971 | 1069 | 66 | 54 | 2 7/8 |
| | | EVPBLFFA6660 | 1052 | 1159 | 66 | 60 | 2 7/8 |



EVPMTU - MONOLITHIC 12”H GLAZED PANEL - TEMPERED GLASS

- Monolithic 12”H Glazed Panel incorporates a lower fabric module with a 12”H top position glazed module, into a solid steel frame.
- Fabric covered modules are tackable and acoustical.
- Opposite sides of each panel may have a different fabric within the same grade at no upcharge.
- If different grades of fabric are used on one panel, the entire panel must be priced at highest grade.
- An aluminum low profile top cap is included.
- Stackability: Evolve panels can be increased in height in 6”H, 12”H, 18”H or 24”H increments. See Extension Modules for part numbers.
- Standard in clear (CLR) glass.
- Frosted glass (FRST) 20% upcharge.

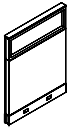
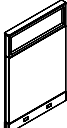
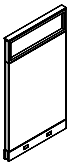
| | DESCRIPTION | PRODUCT CODE | LIST PRICE | | DIMENSIONS/INCHES | | |
|--|---|--------------|------------|------|-------------------|----|-------|
| | | | Gr1 | Gr2 | H | W | D |
|  | Monolithic 12”H Glazed Panel - Tempered Glass - 48” High | EVPMTU4818 | 539 | 570 | 48 | 18 | 2 7/8 |
| | | EVPMTU4824 | 631 | 675 | 48 | 24 | 2 7/8 |
| | | EVPMTU4830 | 732 | 782 | 48 | 30 | 2 7/8 |
| | | EVPMTU4836 | 835 | 896 | 48 | 36 | 2 7/8 |
| | | EVPMTU4842 | 927 | 992 | 48 | 42 | 2 7/8 |
| | | EVPMTU4848 | 1008 | 1084 | 48 | 48 | 2 7/8 |
| | | EVPMTU4854 | 1119 | 1196 | 48 | 54 | 2 7/8 |
| | | EVPMTU4860 | 1227 | 1319 | 48 | 60 | 2 7/8 |
|  | Monolithic 12”H Glazed Panel - Tempered Glass - 54” High | EVPMTU5418 | 556 | 592 | 54 | 18 | 2 7/8 |
| | | EVPMTU5424 | 646 | 687 | 54 | 24 | 2 7/8 |
| | | EVPMTU5430 | 736 | 790 | 54 | 30 | 2 7/8 |
| | | EVPMTU5436 | 821 | 875 | 54 | 36 | 2 7/8 |
| | | EVPMTU5442 | 911 | 977 | 54 | 42 | 2 7/8 |
| | | EVPMTU5448 | 1008 | 1084 | 54 | 48 | 2 7/8 |
| | | EVPMTU5454 | 1103 | 1188 | 54 | 54 | 2 7/8 |
| | | EVPMTU5460 | 1195 | 1289 | 54 | 60 | 2 7/8 |
|  | Monolithic 12”H Glazed Panel - Tempered Glass - 66” High | EVPMTU6618 | 593 | 626 | 66 | 18 | 2 7/8 |
| | | EVPMTU6624 | 710 | 754 | 66 | 24 | 2 7/8 |
| | | EVPMTU6630 | 809 | 863 | 66 | 30 | 2 7/8 |
| | | EVPMTU6636 | 906 | 965 | 66 | 36 | 2 7/8 |
| | | EVPMTU6642 | 1007 | 1073 | 66 | 42 | 2 7/8 |
| | | EVPMTU6648 | 1111 | 1188 | 66 | 48 | 2 7/8 |
| | | EVPMTU6654 | 1215 | 1299 | 66 | 54 | 2 7/8 |
| | | EVPMTU6660 | 1324 | 1414 | 66 | 60 | 2 7/8 |

EVPLMGU - MONOLITHIC 12”H GLAZED LIGHT PANEL - TEMPERED GLASS

- Monolithic 12”H Glazed Light Panel incorporates a lower fabric module with a 12”H top position glazed module, into a solid steel frame.
- There is no base raceway in Light Panels to accommodate electrical.
- Light Panel Connectors must be used in conjunction with Light Panels.
- Fabric covered modules are tackable and acoustical.
- Opposite sides of each panel may have a different fabric within the same grade at no upcharge.
- If different grades of fabric are used on one panel, the entire panel must be priced at highest grade.
- An aluminum low profile top cap is included.
- Stackability: Evolve panels can be increased in height in 6”H, 12”H, 18”H or 24”H increments. See Extension Modules for part numbers.
- Standard in clear (CLR) glass.
- Frosted glass (FRST) 20% upcharge.

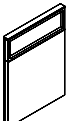
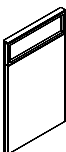
| | DESCRIPTION | PRODUCT CODE | LIST PRICE | | DIMENSIONS/INCHES | | |
|--|---|--------------|------------|------|-------------------|----|-------|
| | | | Gr1 | Gr2 | H | W | D |
|  | Monolithic 12”H Glazed Light Panel - Tempered Glass - 48” High | EVPLMGU4818 | 527 | 557 | 48 | 18 | 2 7/8 |
| | | EVPLMGU4824 | 616 | 656 | 48 | 24 | 2 7/8 |
| | | EVPLMGU4830 | 715 | 766 | 48 | 30 | 2 7/8 |
| | | EVPLMGU4836 | 821 | 875 | 48 | 36 | 2 7/8 |
| | | EVPLMGU4842 | 909 | 972 | 48 | 42 | 2 7/8 |
| | | EVPLMGU4848 | 986 | 1062 | 48 | 48 | 2 7/8 |
| | | EVPLMGU4854 | 1095 | 1171 | 48 | 54 | 2 7/8 |
| | | EVPLMGU4860 | 1204 | 1293 | 48 | 60 | 2 7/8 |
|  | Monolithic 12”H Glazed Light Panel - Tempered Glass - 54” High | EVPLMGU5418 | 544 | 577 | 54 | 18 | 2 7/8 |
| | | EVPLMGU5424 | 633 | 673 | 54 | 24 | 2 7/8 |
| | | EVPLMGU5430 | 721 | 773 | 54 | 30 | 2 7/8 |
| | | EVPLMGU5436 | 806 | 858 | 54 | 36 | 2 7/8 |
| | | EVPLMGU5442 | 896 | 959 | 54 | 42 | 2 7/8 |
| | | EVPLMGU5448 | 986 | 1062 | 54 | 48 | 2 7/8 |
| | | EVPLMGU5454 | 1080 | 1160 | 54 | 54 | 2 7/8 |
| | | EVPLMGU5460 | 1174 | 1262 | 54 | 60 | 2 7/8 |
|  | Monolithic 12”H Glazed Light Panel - Tempered Glass - 66” High | EVPLMGU6618 | 581 | 612 | 66 | 18 | 2 7/8 |
| | | EVPLMGU6624 | 696 | 737 | 66 | 24 | 2 7/8 |
| | | EVPLMGU6630 | 795 | 842 | 66 | 30 | 2 7/8 |
| | | EVPLMGU6636 | 887 | 942 | 66 | 36 | 2 7/8 |
| | | EVPLMGU6642 | 984 | 1052 | 66 | 42 | 2 7/8 |
| | | EVPLMGU6648 | 1088 | 1161 | 66 | 48 | 2 7/8 |
| | | EVPLMGU6654 | 1191 | 1272 | 66 | 54 | 2 7/8 |
| | | EVPLMGU6660 | 1295 | 1383 | 66 | 60 | 2 7/8 |



EVPPFGTU - FABRIC 12”H GLAZED PANEL - TEMPERED GLASS

- Segmented 12”H Glazed Panel incorporates a lower fabric module with a 12”H top position glazed module, into a solid steel frame.
- Panels incorporate 12”H acoustic modules above 30”H base section with a 12”H glazed module at the top.
- Fabric covered modules are tackable and acoustical.
- Opposite sides of each panel may have a different fabric within the same grade at no upcharge.
- If different grades of fabric are used on one panel, the entire panel must be priced at highest grade.
- An aluminum low profile top cap is included.
- Stackability: Evolve panels can be increased in height in 6”H, 12”H, 18”H or 24”H increments. See Extension Modules for part numbers.
- Standard in clear (CLR) glass.
- Frosted glass (FRST) 20% upcharge.

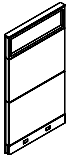
| | DESCRIPTION | PRODUCT CODE | LIST PRICE | | DIMENSIONS/INCHES | | |
|---|--|--------------|------------|------|-------------------|----|-------|
| | | | Gr1 | Gr2 | H | W | D |
|  | Fabric 12” Glazed Panel - Tempered Glass 66” High | EVPPFGTU6618 | 665 | 696 | 66 | 18 | 2 7/8 |
| | | EVPPFGTU6624 | 775 | 818 | 66 | 24 | 2 7/8 |
| | | EVPPFGTU6630 | 885 | 933 | 66 | 30 | 2 7/8 |
| | | EVPPFGTU6636 | 989 | 1048 | 66 | 36 | 2 7/8 |
| | | EVPPFGTU6642 | 1118 | 1180 | 66 | 42 | 2 7/8 |
| | | EVPPFGTU6648 | 1213 | 1286 | 66 | 48 | 2 7/8 |
| | | EVPPFGTU6654 | 1355 | 1435 | 66 | 54 | 2 7/8 |
| | | EVPPFGTU6660 | 1493 | 1580 | 66 | 60 | 2 7/8 |

EVPLFGTU - FABRIC 12”H GLAZED LIGHT PANEL

- Segmented 12”H Glazed Light Panel incorporates a lower fabric module with a 12”H top position glazed module, into a solid steel frame.
- Panels incorporate 12”H acoustic modules above 30”H base section with a 12”H glazed module at the top.
- There is no base raceway in Light Panels to accommodate electrical.
- Light Panel Connectors must be used in conjunction with Light Panels.
- Opposite sides of each panel may have a different fabric within the same grade at no upcharge.
- If different grades of fabric are used on one panel, the entire panel must be priced at highest grade.
- An aluminum low profile top cap is included.
- Stackability: Evolve panels can be increased in height in 6”H, 12”H, 18”H or 24”H increments.
- See Extension Modules for part numbers.
- Standard in clear (CLR) glass.
- Frosted glass (FRST) 20% upcharge.

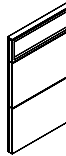
| | DESCRIPTION | PRODUCT CODE | LIST PRICE | | DIMENSIONS/INCHES | | |
|---|---|--------------|------------|------|-------------------|----|-------|
| | | | Gr1 | Gr2 | H | W | D |
|  | Fabric 12”H Glazed Light Panel - 66” High | EVPLFGTU6618 | 649 | 678 | 66 | 18 | 2 7/8 |
| | | EVPLFGTU6624 | 763 | 800 | 66 | 24 | 2 7/8 |
| | | EVPLFGTU6630 | 867 | 911 | 66 | 30 | 2 7/8 |
| | | EVPLFGTU6636 | 972 | 1026 | 66 | 36 | 2 7/8 |
| | | EVPLFGTU6642 | 1094 | 1154 | 66 | 42 | 2 7/8 |
| | | EVPLFGTU6648 | 1187 | 1256 | 66 | 48 | 2 7/8 |
| | | EVPLFGTU6654 | 1327 | 1403 | 66 | 54 | 2 7/8 |
| | | EVPLFGTU6660 | 1465 | 1546 | 66 | 60 | 2 7/8 |

EVFPFGTU - SEGMENTED 12”H GLAZED PANEL - PREMIUM - TEMPERED GLASS

- Segmented 12”H Glazed Premium Panel incorporates a lower fabric module with a 12”H top position glazed module, into a solid steel frame.
- Premium panels incorporate a 6”H base raceway, 24”H base module, 12”H acoustic module and a 12”H glazed module at the top.
- Fabric covered modules are tackable and acoustical.
- Opposite sides of each panel may have a different fabric within the same grade at no upcharge.
- If different grades of fabric are used on one panel, the entire panel must be priced at highest grade.
- An aluminum low profile top cap is included.
- Stackability: Evolve panels can be increased in height in 6”H, 12”H, 18”H or 24”H increments. See Extension Modules for part numbers.
- Standard in clear (CLR) glass.
- Frosted glass (FRST) 20% upcharge.

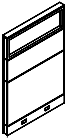
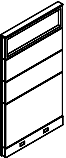
| | DESCRIPTION | PRODUCT CODE | LIST PRICE | | DIMENSIONS/INCHES | | |
|---|---|--------------|------------|------|-------------------|----|-------|
| | | | Gr1 | Gr2 | H | W | D |
|  | Segmented 12”H Glazed Premium Panel - Tempered Glass - 54” High | EVFPFGTU5418 | 612 | 636 | 54 | 18 | 2 7/8 |
| | | EVFPFGTU5424 | 717 | 747 | 54 | 24 | 2 7/8 |
| | | EVFPFGTU5430 | 810 | 849 | 54 | 30 | 2 7/8 |
| | | EVFPFGTU5436 | 911 | 957 | 54 | 36 | 2 7/8 |
| | | EVFPFGTU5442 | 1022 | 1072 | 54 | 42 | 2 7/8 |
| | | EVFPFGTU5448 | 1111 | 1165 | 54 | 48 | 2 7/8 |
| | | EVFPFGTU5454 | 1246 | 1307 | 54 | 54 | 2 7/8 |
| | | EVFPFGTU5460 | 1377 | 1445 | 54 | 60 | 2 7/8 |
|  | Segmented 12”H Glazed Premium Panel - Tempered Glass - 66” High | EVFPFGTU6618 | 748 | 777 | 66 | 18 | 2 7/8 |
| | | EVFPFGTU6624 | 878 | 922 | 66 | 24 | 2 7/8 |
| | | EVFPFGTU6630 | 1000 | 1046 | 66 | 30 | 2 7/8 |
| | | EVFPFGTU6636 | 1122 | 1179 | 66 | 36 | 2 7/8 |
| | | EVFPFGTU6642 | 1267 | 1332 | 66 | 42 | 2 7/8 |
| | | EVFPFGTU6648 | 1371 | 1444 | 66 | 48 | 2 7/8 |
| | | EVFPFGTU6654 | 1533 | 1614 | 66 | 54 | 2 7/8 |
| | | EVFPFGTU6660 | 1702 | 1790 | 66 | 60 | 2 7/8 |

EVPLFPGTU - SEGMENTED 12”H GLAZED PREMIUM LIGHT PANEL – TEMPERED GLASS

- Segmented 12”H Glazed Premium Light Panel incorporates a lower fabric module with a 12”H top position glazed module, into a solid steel frame.
- Premium panels incorporate a 30”H base section, 12”H acoustic module and a 12”H glazed module at the top.
- There is no base raceway in Light Panels to accommodate electrical.
- Light Panel Connectors must be used in conjunction with Light Panels.
- Opposite sides of each panel may have a different fabric within the same grade at no upcharge.
- If different grades of fabric are used on one panel, the entire panel must be priced at highest grade.
- An aluminum low profile top cap is included.
- Stackability: Evolve panels can be increased in height in 6”H, 12”H, 18”H or 24”H increments.
- See Extension Modules for part numbers.
- Standard in clear (CLR) glass.
- Frosted glass (FRST) 20% upcharge.

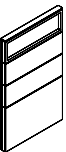
| | DESCRIPTION | PRODUCT CODE | LIST PRICE | | DIMENSIONS/INCHES | | |
|---|---|---------------|------------|------|-------------------|----|-------|
| | | | Gr1 | Gr2 | H | W | D |
|  | Segmented 12”H Glazed Premium Panel - Premium - Tempered Glass - 54” High | EVPLFPGTU5418 | 600 | 621 | 54 | 18 | 2 7/8 |
| | | EVPLFPGTU5424 | 704 | 733 | 54 | 24 | 2 7/8 |
| | | EVPLFPGTU5430 | 796 | 830 | 54 | 30 | 2 7/8 |
| | | EVPLFPGTU5436 | 896 | 932 | 54 | 36 | 2 7/8 |
| | | EVPLFPGTU5442 | 1004 | 1052 | 54 | 42 | 2 7/8 |
| | | EVPLFPGTU5448 | 1088 | 1141 | 54 | 48 | 2 7/8 |
| | | EVPLFPGTU5454 | 1220 | 1278 | 54 | 54 | 2 7/8 |
| | | EVPLFPGTU5460 | 1348 | 1414 | 54 | 60 | 2 7/8 |
|  | Segmented 12”H Glazed Premium Panel - Premium - Tempered Glass - 66” High | EVPLFPGTU6618 | 735 | 764 | 66 | 18 | 2 7/8 |
| | | EVPLFPGTU6624 | 862 | 901 | 66 | 24 | 2 7/8 |
| | | EVPLFPGTU6630 | 978 | 1021 | 66 | 30 | 2 7/8 |
| | | EVPLFPGTU6636 | 1102 | 1154 | 66 | 36 | 2 7/8 |
| | | EVPLFPGTU6642 | 1242 | 1304 | 66 | 42 | 2 7/8 |
| | | EVPLFPGTU6648 | 1344 | 1413 | 66 | 48 | 2 7/8 |
| | | EVPLFPGTU6654 | 1501 | 1578 | 66 | 54 | 2 7/8 |
| | | EVPLFPGTU6660 | 1669 | 1756 | 66 | 60 | 2 7/8 |



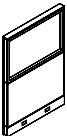
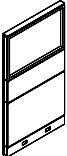

EVPPFGT - PARTLY GLAZED PANEL - TEMPERED GLASS

- Partly Glazed Panel incorporates a lower fabric module with a 12”H or 24”H top position glazed module, into a solid steel frame.
- Opposite sides of each panel may have a different fabric within the same grade at no upcharge.
- If different grades of fabric are used on one panel, the entire panel must be priced at highest grade.
- An aluminum low profile top cap is included.
- Stackability: Evolve panels can be increased in height in 6”H, 12”H, 18”H or 24”H increments. See Extension Modules for part numbers.
- Standard in clear (CLR) glass.
- Frosted glass (FRST) 20% upcharge.

| | DESCRIPTION | PRODUCT CODE | LIST PRICE | | DIMENSIONS/INCHES | | |
|--|---|--------------|------------|------|-------------------|----|-------|
| | | | Gr1 | Gr2 | H | W | D |
|  | Partly Glazed Panel - Tempered Glass - 42" High | EVPPFGT4218 | 471 | 489 | 42 | 18 | 2 7/8 |
| | | EVPPFGT4224 | 556 | 577 | 42 | 24 | 2 7/8 |
| | | EVPPFGT4230 | 629 | 655 | 42 | 30 | 2 7/8 |
| | | EVPPFGT4236 | 702 | 732 | 42 | 36 | 2 7/8 |
| | | EVPPFGT4242 | 780 | 815 | 42 | 42 | 2 7/8 |
| | | EVPPFGT4248 | 854 | 889 | 42 | 48 | 2 7/8 |
| | | EVPPFGT4254 | 954 | 992 | 42 | 54 | 2 7/8 |
| | | EVPPFGT4260 | 1053 | 1099 | 42 | 60 | 2 7/8 |
|  | Partly Glazed Panel - Tempered Glass - 54" High | EVPPFGT5418 | 520 | 541 | 54 | 18 | 2 7/8 |
| | | EVPPFGT5424 | 604 | 628 | 54 | 24 | 2 7/8 |
| | | EVPPFGT5430 | 702 | 728 | 54 | 30 | 2 7/8 |
| | | EVPPFGT5436 | 796 | 826 | 54 | 36 | 2 7/8 |
| | | EVPPFGT5442 | 889 | 922 | 54 | 42 | 2 7/8 |
| | | EVPPFGT5448 | 970 | 1008 | 54 | 48 | 2 7/8 |
| | | EVPPFGT5454 | 1124 | 1165 | 54 | 54 | 2 7/8 |
| | | EVPPFGT5460 | 1276 | 1325 | 54 | 60 | 2 7/8 |
|  | Partly Glazed Panel - Tempered Glass - 66" High | EVPPFGT6618 | 659 | 685 | 66 | 18 | 2 7/8 |
| | | EVPPFGT6624 | 767 | 798 | 66 | 24 | 2 7/8 |
| | | EVPPFGT6630 | 885 | 923 | 66 | 30 | 2 7/8 |
| | | EVPPFGT6636 | 1007 | 1051 | 66 | 36 | 2 7/8 |
| | | EVPPFGT6642 | 1131 | 1184 | 66 | 42 | 2 7/8 |
| | | EVPPFGT6648 | 1229 | 1284 | 66 | 48 | 2 7/8 |
| | | EVPPFGT6654 | 1414 | 1476 | 66 | 54 | 2 7/8 |
| | | EVPPFGT6660 | 1600 | 1668 | 66 | 60 | 2 7/8 |

EVPLFGT - PARTLY GLAZED LIGHT PANEL - TEMPERED GLASS

- Partly Glazed Light Panel incorporates a lower fabric module with a 12”H or 24”H top position glazed module, into a solid steel frame.
- There is no base raceway in Light Panels to accommodate electrical.
- Light Panel Connectors must be used in conjunction with Light Panels.
- Opposite sides of each panel may have a different fabric within the same grade at no upcharge.
- If different grades of fabric are used on one panel, the entire panel must be priced at highest grade.
- An aluminum low profile top cap is included.
- Stackability: Evolve panels can be increased in height in 6”H, 12”H, 18”H or 24”H increments. See Extension Modules for part numbers.
- Standard in clear (CLR) glass.
- Frosted glass (FRST) 20% upcharge.

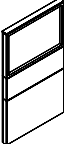
| | DESCRIPTION | PRODUCT CODE | LIST PRICE | | DIMENSIONS/INCHES | | |
|--|--|--------------|------------|------|-------------------|----|-------|
| | | | Gr1 | Gr2 | H | W | D |
|  | Partly Glazed Light Panel - Tempered Glass - 42” High | EVPLFGT4218 | 460 | 477 | 42 | 18 | 2 7/8 |
| | | EVPLFGT4224 | 544 | 564 | 42 | 24 | 2 7/8 |
| | | EVPLFGT4230 | 615 | 641 | 42 | 30 | 2 7/8 |
| | | EVPLFGT4236 | 685 | 714 | 42 | 36 | 2 7/8 |
| | | EVPLFGT4242 | 767 | 799 | 42 | 42 | 2 7/8 |
| | | EVPLFGT4248 | 834 | 869 | 42 | 48 | 2 7/8 |
| | | EVPLFGT4254 | 932 | 972 | 42 | 54 | 2 7/8 |
| | | EVPLFGT4260 | 1032 | 1073 | 42 | 60 | 2 7/8 |
|  | Partly Glazed Light Panel - Tempered Glass - 54” High | EVPLFGT5418 | 511 | 525 | 54 | 18 | 2 7/8 |
| | | EVPLFGT5424 | 593 | 612 | 54 | 24 | 2 7/8 |
| | | EVPLFGT5430 | 685 | 710 | 54 | 30 | 2 7/8 |
| | | EVPLFGT5436 | 777 | 808 | 54 | 36 | 2 7/8 |
| | | EVPLFGT5442 | 872 | 905 | 54 | 42 | 2 7/8 |
| | | EVPLFGT5448 | 951 | 984 | 54 | 48 | 2 7/8 |
| | | EVPLFGT5454 | 1103 | 1141 | 54 | 54 | 2 7/8 |
| | | EVPLFGT5460 | 1251 | 1295 | 54 | 60 | 2 7/8 |
|  | Partly Glazed Light Panel - Tempered Glass - 66” High | EVPLFGT6618 | 647 | 673 | 66 | 18 | 2 7/8 |
| | | EVPLFGT6624 | 748 | 779 | 66 | 24 | 2 7/8 |
| | | EVPLFGT6630 | 867 | 902 | 66 | 30 | 2 7/8 |
| | | EVPLFGT6636 | 984 | 1026 | 66 | 36 | 2 7/8 |
| | | EVPLFGT6642 | 1111 | 1158 | 66 | 42 | 2 7/8 |
| | | EVPLFGT6648 | 1207 | 1256 | 66 | 48 | 2 7/8 |
| | | EVPLFGT6654 | 1385 | 1445 | 66 | 54 | 2 7/8 |
| | | EVPLFGT6660 | 1569 | 1631 | 66 | 60 | 2 7/8 |



EVPPFGTX - PARTLY GLAZED PANEL - 36”H TEMPERED GLASS

- Partly Glazed Panel incorporates a lower fabric module with 36”H top position glazed module, into a solid steel frame.
- Opposite sides of each panel may have a different fabric within the same grade at no upcharge.
- If different grades of fabric are used on one panel, the entire panel must be priced at highest grade.
- An aluminum low profile top cap is included.
- Stackability: Evolve panels can be increased in height in 6”H, 12”H, 18”H or 24”H increments. See Extension Modules for part numbers.
- Standard in clear (CLR) glass.
- Frosted glass (FRST) 40% upcharge.

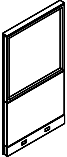
| | DESCRIPTION | PRODUCT CODE | LIST PRICE | | DIMENSIONS/INCHES | | |
|---|---------------------------|--------------|------------|------|-------------------|----|-------|
| | | | Gr1 | Gr2 | H | W | D |
|  | Fabric 36” Glazed Panel - | EVPPFGTX6618 | 764 | 779 | 66 | 18 | 2 7/8 |
| | Tempered Glass - 66” High | EVPPFGTX6624 | 842 | 867 | 66 | 24 | 2 7/8 |
| | | EVPPFGTX6630 | 976 | 1004 | 66 | 30 | 2 7/8 |
| | | EVPPFGTX6636 | 1110 | 1139 | 66 | 36 | 2 7/8 |
| | | EVPPFGTX6642 | 1241 | 1274 | 66 | 42 | 2 7/8 |
| | | EVPPFGTX6648 | 1358 | 1394 | 66 | 48 | 2 7/8 |
| | | EVPPFGTX6654 | 1493 | 1536 | 66 | 54 | 2 7/8 |
| | | EVPPFGTX6660 | 1628 | 1675 | 66 | 60 | 2 7/8 |

EVPLFGTX - PARTLY GLAZED LIGHT PANEL - 36”H TEMPERED GLASS

- Partly Glazed Light Panel incorporates a lower fabric module with 36”H top position glazed module, into a solid steel frame.
- There is no base raceway in Light Panels to accommodate electrical.
- Light Panel Connectors must be used in conjunction with Light Panels.
- Opposite sides of each panel may have a different fabric within the same grade at no upcharge.
- If different grades of fabric are used on one panel, the entire panel must be priced at highest grade.
- An aluminum low profile top cap is included.
- Stackability: Evolve panels can be increased in height in 6”H, 12”H, 18”H or 24”H increments. See Extension Modules for part numbers.
- Standard in clear (CLR) glass.
- Frosted glass (FRST) 40% upcharge.

| | DESCRIPTION | PRODUCT CODE | LIST PRICE | | DIMENSIONS/INCHES | | |
|---|--------------------------------|--------------|------------|------|-------------------|----|-------|
| | | | Gr1 | Gr2 | H | W | D |
|  | Partly Glazed Light Panel - | EVPLFGTX6618 | 737 | 751 | 66 | 18 | 2 7/8 |
| | 36”H Tempered Glass - 66” High | EVPLFGTX6624 | 816 | 838 | 66 | 24 | 2 7/8 |
| | | EVPLFGTX6630 | 948 | 970 | 66 | 30 | 2 7/8 |
| | | EVPLFGTX6636 | 1074 | 1104 | 66 | 36 | 2 7/8 |
| | | EVPLFGTX6642 | 1204 | 1234 | 66 | 42 | 2 7/8 |
| | | EVPLFGTX6648 | 1317 | 1353 | 66 | 48 | 2 7/8 |
| | | EVPLFGTX6654 | 1448 | 1485 | 66 | 54 | 2 7/8 |
| | | EVPLFGTX6660 | 1580 | 1625 | 66 | 60 | 2 7/8 |

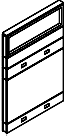
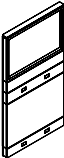

EVPBFGT - PARTLY GLAZED BELTLINE POWERED PANEL

- Partly Glazed Beltline Powered Panel incorporates fabric modules with a power beltline raceway and a 12”H or 24”H glazed module, within a solid steel frame.
- A Chimney Panel is required to run electric and data from the base to belt.
- 6”H power beltline raceway, to accommodate electrical, is metal with knockouts on both sides.
- Beltline Connectors must be used in conjunction with beltline panels.
- Opposite sides of each panel may have a different fabric within the same grade at no upcharge.
- If different grades of fabric are used on one panel, the entire panel must be priced at highest grade.
- An aluminum low profile top cap is included.
- Stackability: Evolve panels can be increased in height in 6”H, 12”H, 18”H or 24”H increments. See Extension Modules for part numbers.
- Standard in clear (CLR) glass.
- Frosted glass (FRST) 20% upcharge.

| | DESCRIPTION | PRODUCT CODE | LIST PRICE | | DIMENSIONS/INCHES | | |
|---|---|--------------|------------|------|-------------------|----|-------|
| | | | Gr1 | Gr2 | H | W | D |
|  | Partly Glazed Beltline Powered Panel - 54” High | EVPBFGT5424 | 770 | 796 | 54 | 24 | 2 7/8 |
| | 24” Fabric /6” Power Belt/ 6” Fabric /12” Glass | EVPBFGT5430 | 902 | 930 | 54 | 30 | 2 7/8 |
| | | EVPBFGT5436 | 1026 | 1061 | 54 | 36 | 2 7/8 |
| | | EVPBFGT5442 | 1155 | 1194 | 54 | 42 | 2 7/8 |
| | | EVPBFGT5448 | 1280 | 1325 | 54 | 48 | 2 7/8 |
| | | EVPBFGT5454 | 1404 | 1454 | 54 | 54 | 2 7/8 |
| | | EVPBFGT5460 | 1531 | 1584 | 54 | 60 | 2 7/8 |
|  | Partly Glazed Beltline Powered Panel - 66” High | EVPBFGT6624 | 874 | 900 | 66 | 24 | 2 7/8 |
| | 24” Fabric /6” Power Belt/ 6” Fabric /24” Glass | EVPBFGT6630 | 1019 | 1049 | 66 | 30 | 2 7/8 |
| | | EVPBFGT6636 | 1159 | 1193 | 66 | 36 | 2 7/8 |
| | | EVPBFGT6642 | 1302 | 1341 | 66 | 42 | 2 7/8 |
| | | EVPBFGT6648 | 1436 | 1483 | 66 | 48 | 2 7/8 |
| | | EVPBFGT6654 | 1580 | 1615 | 66 | 54 | 2 7/8 |
| | | EVPBFGT6660 | 1720 | 1773 | 66 | 60 | 2 7/8 |

EVPBLFGT - PARTLY GLAZED BELTLINE POWER LIGHT PANEL

- Partly Glazed Beltline Powered Light Panel incorporates fabric modules with a power beltline raceway and a 12”H or 24”H glazed module, within a solid steel frame.
- 6”H power beltline raceway, to accommodate electrical, is metal with knockouts on both sides.
- There is no base raceway in Light Panels to accommodate electrical.
- Light Beltline Panel Connectors must be used in conjunction with Light Beltline Panels.
- Opposite sides of each panel may have a different fabric within the same grade at no upcharge.
- If different grades of fabric are used on one panel, the entire panel must be priced at highest grade.
- An aluminum low profile top cap is included.
- Stackability: Evolve Light panels can be increased in height in 6”H, 12”H, 18”H or 24”H increments. See Extension Modules for part numbers.
- Standard in clear (CLR) glass.
- Frosted glass (FRST) 20% upcharge.

| | DESCRIPTION | PRODUCT CODE | LIST PRICE | | DIMENSIONS/INCHES | | |
|---|---|--------------|------------|------|-------------------|----|-------|
| | | | Gr1 | Gr2 | H | W | D |
|  | Partly Glazed Beltline Powered Light Panel - 54” High | EVPBLFGT5424 | 733 | 757 | 54 | 24 | 2 7/8 |
| | 24” Fabric /6” Power Belt/ 6” Fabric /12” Glass | EVPBLFGT5430 | 858 | 886 | 54 | 30 | 2 7/8 |
| | | EVPBLFGT5436 | 974 | 1009 | 54 | 36 | 2 7/8 |
| | | EVPBLFGT5442 | 1098 | 1138 | 54 | 42 | 2 7/8 |
| | | EVPBLFGT5448 | 1215 | 1259 | 54 | 48 | 2 7/8 |
| | | EVPBLFGT5454 | 1335 | 1385 | 54 | 54 | 2 7/8 |
| | | EVPBLFGT5460 | 1454 | 1509 | 54 | 60 | 2 7/8 |
|  | Partly Glazed Beltline Powered Light Panel - 66” High | EVPBLFGT6624 | 830 | 855 | 66 | 24 | 2 7/8 |
| | 24” Fabric /6” Power Belt/ 6” Fabric /24” Glass | EVPBLFGT6630 | 968 | 999 | 66 | 30 | 2 7/8 |
| | | EVPBLFGT6636 | 1102 | 1136 | 66 | 36 | 2 7/8 |
| | | EVPBLFGT6642 | 1235 | 1276 | 66 | 42 | 2 7/8 |
| | | EVPBLFGT6648 | 1368 | 1413 | 66 | 48 | 2 7/8 |
| | | EVPBLFGT6654 | 1501 | 1549 | 66 | 54 | 2 7/8 |
| | | EVPBLFGT6660 | 1632 | 1688 | 66 | 60 | 2 7/8 |



EVPBCFGT - PARTLY GLAZED BELTLINE POWERED CHIMNEY PANEL - TEMPERED GLASS

- Partly Glazed Beltline Powered Chimney Panel incorporates fabric modules with a power beltline raceway and a 12”H or 24”H glazed module, within a solid steel frame.
- A Chimney Panel is required to run electric and data from the base to belt.
- Separate electric harness required to go from base to belt (see EVE8CPCP).
- 6”H power beltline raceway, to accommodate electrical, is metal with knockouts on both sides.
- Beltline Connectors must be used in conjunction with beltline panels.
- Opposite sides of each panel may have a different fabric within the same grade at no upcharge.
- If different grades of fabric are used on one panel, the entire panel must be priced at highest grade.
- An aluminum low profile top cap is included.
- Stackability: Evolve panels can be increased in height in 6”H, 12”H, 18”H or 24”H increments. See Extension Modules for part numbers.
- Standard in clear (CLR) glass.
- Frosted glass (FRST) 20% upcharge.

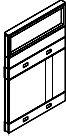
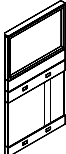
| | DESCRIPTION | PRODUCT CODE | LIST PRICE | | DIMENSIONS/INCHES | | |
|---|--|--------------|------------|------|-------------------|----|-------|
| | | | Gr1 | Gr2 | H | W | D |
|  | Partly Glazed Beltline Powered Chimney Panel - Tempered Glass - 54” High | EVPBCFGT5436 | 1105 | 1141 | 54 | 36 | 2 7/8 |
| | 24” Fabric Chimney /6” Power Belt / 6” Fabric /12” Glass | EVPBCFGT5442 | 1235 | 1276 | 54 | 42 | 2 7/8 |
|  | Partly Glazed Beltline Powered Chimney Panel - Tempered Glass - 66” High | EVPBCFGT6636 | 1254 | 1290 | 66 | 36 | 2 7/8 |
| | 24” Fabric Chimney /6” Power Belt / 6” Fabric /24” Glass | EVPBCFGT6642 | 1383 | 1423 | 66 | 42 | 2 7/8 |

EVE8CPCP - CHIMNEY PANEL JUMPER CABLE KIT

- Contains two (2) 17” flexible harnesses and one (1) “I” connector.
- Used to connect electric from the base to the beltline raceway in Beltline Powered Chimney panel.
- Must use in conjunction with base power distribution harness and beltline power distribution harness (sold separately)

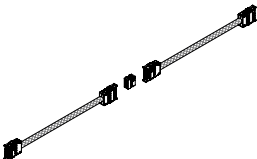
| | DESCRIPTION | PRODUCT CODE | LIST PRICE | DIMENSIONS/INCHES | | |
|---|--------------------------------|--------------|------------|-------------------|---|---|
| | | | | H | W | D |
|  | Chimney Panel Jumper Cable Kit | EVE8CPCP | 341 | | | |

EVFPFGT - PARTLY GLAZED PREMIUM PANEL - TEMPERED GLASS

- Partly Glazed Premium Panel incorporates 12”H glazed modules above 30”H fabric base section.
- Opposite sides of each panel may have a different fabric within the same grade at no upcharge.
- If different grades of fabric are used on one panel, the entire panel must be priced at highest grade.
- An aluminum low profile top cap is included.
- Stackability: Evolve panels can be increased in height in 6”H, 12”H, 18”H or 24”H increments. See Extension Modules for part numbers.
- Standard in clear (CLR) glass.
- Frosted glass (FRST) 20% upcharge.

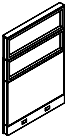
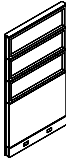
| | DESCRIPTION | PRODUCT CODE | LIST PRICE | | DIMENSIONS/INCHES | | |
|---|---|--------------|------------|------|-------------------|----|-------|
| | | | Gr1 | Gr2 | H | W | D |
|  | Partly Glazed Premium Panel - Tempered Glass - 54” High | EVFPFGT5418 | 629 | 648 | 54 | 18 | 2 7/8 |
| | | EVFPFGT5424 | 748 | 769 | 54 | 24 | 2 7/8 |
| | | EVFPFGT5430 | 839 | 867 | 54 | 30 | 2 7/8 |
| | | EVFPFGT5436 | 932 | 963 | 54 | 36 | 2 7/8 |
| | | EVFPFGT5442 | 1040 | 1073 | 54 | 42 | 2 7/8 |
| | | EVFPFGT5448 | 1144 | 1182 | 54 | 48 | 2 7/8 |
| | | EVFPFGT5454 | 1280 | 1323 | 54 | 54 | 2 7/8 |
| | | EVFPFGT5460 | 1412 | 1460 | 54 | 60 | 2 7/8 |
|  | Partly Glazed Premium Panel - Tempered Glass - 66” High | EVFPFGT6618 | 784 | 802 | 66 | 18 | 2 7/8 |
| | | EVFPFGT6624 | 942 | 969 | 66 | 24 | 2 7/8 |
| | | EVFPFGT6630 | 1058 | 1083 | 66 | 30 | 2 7/8 |
| | | EVFPFGT6636 | 1163 | 1193 | 66 | 36 | 2 7/8 |
| | | EVFPFGT6642 | 1297 | 1332 | 66 | 42 | 2 7/8 |
| | | EVFPFGT6648 | 1433 | 1474 | 66 | 48 | 2 7/8 |
| | | EVFPFGT6654 | 1620 | 1666 | 66 | 54 | 2 7/8 |
| | | EVFPFGT6660 | 1803 | 1851 | 66 | 60 | 2 7/8 |

EVPLFPGT - PARTLY GLAZED PREMIUM LIGHT PANEL – TEMPERED GLASS

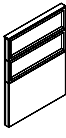
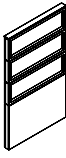

- Partly Glazed Premium Panel incorporates 12”H glazed modules above 30”H fabric base section.
- There is no base raceway in Light Panels to accommodate electrical.
- Light Panel Connectors must be used in conjunction with Light Panels.
- Opposite sides of each panel may have a different fabric within the same grade at no upcharge.
- If different grades of fabric are used on one panel, the entire panel must be priced at highest grade.
- An aluminum low profile top cap is included.
- Stackability: Evolve panels can be increased in height in 6”H, 12”H, 18”H or 24”H increments.
- See Extension Modules for part numbers.
- Standard in clear (CLR) glass.
- Frosted glass (FRST) 20% upcharge.

| | DESCRIPTION | PRODUCT CODE | LIST PRICE | | DIMENSIONS/INCHES | | |
|---|---|--------------|------------|------|-------------------|----|-------|
| | | | Gr1 | Gr2 | H | W | D |
|  | Partly Glazed Premium Light Panel - Tempered Glass - 54” High | EVPLFPGT5418 | 608 | 626 | 54 | 18 | 2 7/8 |
| | | EVPLFPGT5424 | 728 | 745 | 54 | 24 | 2 7/8 |
| | | EVPLFPGT5430 | 813 | 838 | 54 | 30 | 2 7/8 |
| | | EVPLFPGT5436 | 908 | 932 | 54 | 36 | 2 7/8 |
| | | EVPLFPGT5442 | 1009 | 1040 | 54 | 42 | 2 7/8 |
| | | EVPLFPGT5448 | 1111 | 1144 | 54 | 48 | 2 7/8 |
| | | EVPLFPGT5454 | 1241 | 1281 | 54 | 54 | 2 7/8 |
| | | EVPLFPGT5460 | 1369 | 1414 | 54 | 60 | 2 7/8 |
|  | Partly Glazed Premium Light Panel - Tempered Glass - 66” High | EVPLFPGT6618 | 764 | 775 | 66 | 18 | 2 7/8 |
| | | EVPLFPGT6624 | 916 | 938 | 66 | 24 | 2 7/8 |
| | | EVPLFPGT6630 | 1022 | 1049 | 66 | 30 | 2 7/8 |
| | | EVPLFPGT6636 | 1129 | 1159 | 66 | 36 | 2 7/8 |
| | | EVPLFPGT6642 | 1260 | 1291 | 66 | 42 | 2 7/8 |
| | | EVPLFPGT6648 | 1389 | 1426 | 66 | 48 | 2 7/8 |
| | | EVPLFPGT6654 | 1570 | 1610 | 66 | 54 | 2 7/8 |
| | | EVPLFPGT6660 | 1752 | 1793 | 66 | 60 | 2 7/8 |





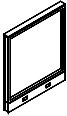
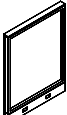
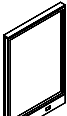

EVPXGT - FULLY GLAZED MONOLITHIC PANEL - TEMPERED GLASS

- Fully Glazed Monolithic Panels are incorporated into a solid steel frame.
- An aluminum low profile top cap is included.
- Stackability: Evolve panels can be increased in height in 6”H, 12”H, 18”H or 24”H increments. See Extension Modules for part numbers.
- Standard in clear (CLR) glass.
- Frosted glass (FRST) 40% upcharge.

| | DESCRIPTION | PRODUCT CODE | LIST PRICE | DIMENSIONS/INCHES | | |
|--|---|--------------|------------|-------------------|----|-------|
| | | | | H | W | D |
|  | Fully Glazed Monolithic Panel - Tempered Glass - 42” High | EVPXGT4218 | 504 | 42 | 18 | 2 7/8 |
| | | EVPXGT4224 | 556 | 42 | 24 | 2 7/8 |
| | | EVPXGT4230 | 646 | 42 | 30 | 2 7/8 |
| | | EVPXGT4236 | 726 | 42 | 36 | 2 7/8 |
| | | EVPXGT4242 | 808 | 42 | 42 | 2 7/8 |
|  | Fully Glazed Monolithic Panel - Tempered Glass - 48” High | EVPXGT4818 | 450 | 48 | 18 | 2 7/8 |
| | | EVPXGT4824 | 575 | 48 | 24 | 2 7/8 |
| | | EVPXGT4830 | 635 | 48 | 30 | 2 7/8 |
| | | EVPXGT4836 | 784 | 48 | 36 | 2 7/8 |
| | | EVPXGT4842 | 827 | 48 | 42 | 2 7/8 |
|  | Fully Glazed Monolithic Panel - Tempered Glass - 54” High | EVPXGT5418 | 558 | 54 | 18 | 2 7/8 |
| | | EVPXGT5424 | 656 | 54 | 24 | 2 7/8 |
| | | EVPXGT5430 | 763 | 54 | 30 | 2 7/8 |
| | | EVPXGT5436 | 858 | 54 | 36 | 2 7/8 |
| | | EVPXGT5442 | 951 | 54 | 42 | 2 7/8 |
|  | Fully Glazed Monolithic Panel - Tempered Glass - 66” High | EVPXGT6618 | 655 | 66 | 18 | 2 7/8 |
| | | EVPXGT6624 | 757 | 66 | 24 | 2 7/8 |
| | | EVPXGT6630 | 874 | 66 | 30 | 2 7/8 |
| | | EVPXGT6636 | 983 | 66 | 36 | 2 7/8 |
| | | EVPXGT6642 | 1094 | 66 | 42 | 2 7/8 |

EVPLXGT - FULLY GLAZED MONOLITHIC LIGHT PANEL - TEMPERED GLASS

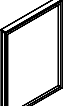
- Fully Glazed Monolithic Light Panels are incorporated into a solid steel frame.
- There is no base raceway in Light Panels to accommodate electrical.
- Light Panel Connectors must be used in conjunction with Light Panels.
- An aluminum low profile top cap is included.
- Stackability: Evolve panels can be increased in height in 6”H, 12”H, 18”H or 24”H increments. See Extension Modules for part numbers.
- Standard in clear (CLR) glass.
- Frosted glass (FRST) 40% upcharge.

| | DESCRIPTION | PRODUCT CODE | LIST PRICE | DIMENSIONS/INCHES | | |
|---|---|--------------|------------|-------------------|----|-------|
| | | | | H | W | D |
|  | Fully Glazed Monolithic Light Panel - Tempered Glass - 42” High | EVPLXGT4218 | 479 | 42 | 18 | 2 7/8 |
| | | EVPLXGT4224 | 528 | 42 | 24 | 2 7/8 |
| | | EVPLXGT4230 | 613 | 42 | 30 | 2 7/8 |
| | | EVPLXGT4236 | 687 | 42 | 36 | 2 7/8 |
| | | EVPLXGT4242 | 768 | 42 | 42 | 2 7/8 |
|  | Fully Glazed Monolithic Light Panel - Tempered Glass - 48” High | EVPLXGT4818 | 424 | 48 | 18 | 2 7/8 |
| | | EVPLXGT4824 | 546 | 48 | 24 | 2 7/8 |
| | | EVPLXGT4830 | 604 | 48 | 30 | 2 7/8 |
| | | EVPLXGT4836 | 746 | 48 | 36 | 2 7/8 |
| | | EVPLXGT4842 | 781 | 48 | 42 | 2 7/8 |
|  | Fully Glazed Monolithic Light Panel - Tempered Glass - 54” | EVPLXGT5418 | 533 | 54 | 18 | 2 7/8 |
| | | EVPLXGT5424 | 625 | 54 | 24 | 2 7/8 |
| | | EVPLXGT5430 | 719 | 54 | 30 | 2 7/8 |
| | | EVPLXGT5436 | 813 | 54 | 36 | 2 7/8 |
| | | EVPLXGT5442 | 902 | 54 | 42 | 2 7/8 |
|  | Fully Glazed Monolithic Light Panel - Tempered Glass - 66” High | EVPLXGT6618 | 624 | 66 | 18 | 2 7/8 |
| | | EVPLXGT6624 | 718 | 66 | 24 | 2 7/8 |
| | | EVPLXGT6630 | 831 | 66 | 30 | 2 7/8 |
| | | EVPLXGT6636 | 932 | 66 | 36 | 2 7/8 |
| | | EVPLXGT6642 | 1040 | 66 | 42 | 2 7/8 |

EVPGT - FULLY GLAZED SEGMENTED PANEL - TEMPERED GLASS

- Fully Glazed Segmented Panel incorporates (2) 24”H Glazed modules into a solid steel frame.
- An aluminum low profile top cap is included.
- Stackability: Evolve panels can be increased in height in 6”H, 12”H, 18”H or 24”H increments. See Extension Modules for part numbers.
- Standard in clear (CLR) glass.
- Frosted glass (FRST) 40% upcharge.

| | DESCRIPTION | PRODUCT CODE | LIST PRICE | DIMENSIONS/INCHES | | |
|---|--|--------------|------------|-------------------|----|-------|
| | | | | H | W | D |
|  | Fully Glazed Segmented Panel - Tempered Glass - 54” High | EVPGT5418 | 714 | 54 | 18 | 2 7/8 |
| | | EVPGT5424 | 875 | 54 | 24 | 2 7/8 |
| | | EVPGT5430 | 968 | 54 | 30 | 2 7/8 |
| | | EVPGT5436 | 1058 | 54 | 36 | 2 7/8 |
| | | EVPGT5442 | 1171 | 54 | 42 | 2 7/8 |
| | | EVPGT5448 | 1306 | 54 | 48 | 2 7/8 |
| | | EVPGT5454 | 1436 | 54 | 54 | 2 7/8 |
| | | EVPGT5460 | 1569 | 54 | 60 | 2 7/8 |





EVPLGT - FULLY GLAZED SEGMENTED LIGHT PANEL - TEMPERED GLASS

- Fully Glazed Segmented Light Panel incorporates (2) 24”H Glazed modules into a solid steel frame.
- There is no base raceway in Light Panels to accommodate electrical.
- Light Panel Connectors must be used in conjunction with Light Panels.
- An aluminum low profile top cap is included.
- Stackability: Evolve panels can be increased in height in 6”H, 12”H, 18”H or 24”H increments. See Extension Modules for part numbers.
- Standard in clear (CLR) glass.
- Frosted glass (FRST) 40% upcharge.

| | DESCRIPTION | PRODUCT CODE | LIST PRICE | DIMENSIONS/INCHES | | |
|---|---|--------------|------------|-------------------|----|-------|
| | | | | H | W | D |
|  | Fully Glazed Segmented Light Panel Tempered Glass - 54” High | EVPLGT5418 | 678 | 54 | 18 | 2 7/8 |
| | | EVPLGT5424 | 833 | 54 | 24 | 2 7/8 |
| | | EVPLGT5430 | 920 | 54 | 30 | 2 7/8 |
| | | EVPLGT5436 | 1004 | 54 | 36 | 2 7/8 |
| | | EVPLGT5442 | 1115 | 54 | 42 | 2 7/8 |
| | | EVPLGT5448 | 1240 | 54 | 48 | 2 7/8 |
| | | EVPLGT5454 | 1366 | 54 | 54 | 2 7/8 |
| | | EVPLGT5460 | 1489 | 54 | 60 | 2 7/8 |

EVPGPT - FULLY GLAZED PREMIUM PANEL - TEMPERED GLASS

- Fully Glazed Premium Panel incorporates 12”H Glazed Modules into a solid steel frame.
- An aluminum low profile top cap is included.
- Stackability: Evolve panels can be increased in height in 6”H, 12”H, 18”H or 24”H increments. See Extension Modules for part numbers.
- Standard in clear (CLR) glass.
- Frosted glass (FRST) 40% upcharge.

| | DESCRIPTION | PRODUCT CODE | LIST PRICE | DIMENSIONS/INCHES | | |
|---|---|--------------|------------|-------------------|----|-------|
| | | | | H | W | D |
|  | Fully Glazed Premium Panel - Tempered Glass - 42” High | EVPGPT4218 | 704 | 42 | 18 | 2 7/8 |
| | | EVPGPT4224 | 862 | 42 | 24 | 2 7/8 |
| | | EVPGPT4230 | 954 | 42 | 30 | 2 7/8 |
| | | EVPGPT4236 | 1040 | 42 | 36 | 2 7/8 |
| | | EVPGPT4242 | 1154 | 42 | 42 | 2 7/8 |
| | | EVPGPT4248 | 1282 | 42 | 48 | 2 7/8 |
| | | EVPGPT4254 | 1413 | 42 | 54 | 2 7/8 |
| | | EVPGPT4260 | 1539 | 42 | 60 | 2 7/8 |
|  | Fully Glazed Premium Panel - Tempered Glass - 54” High | EVPGPT5418 | 890 | 54 | 18 | 2 7/8 |
| | | EVPGPT5424 | 1094 | 54 | 24 | 2 7/8 |
| | | EVPGPT5430 | 1210 | 54 | 30 | 2 7/8 |
| | | EVPGPT5436 | 1317 | 54 | 36 | 2 7/8 |
| | | EVPGPT5442 | 1465 | 54 | 42 | 2 7/8 |
| | | EVPGPT5448 | 1630 | 54 | 48 | 2 7/8 |
| | | EVPGPT5454 | 1798 | 54 | 54 | 2 7/8 |
| | | EVPGPT5460 | 1960 | 54 | 60 | 2 7/8 |
|  | Fully Glazed Premium Panel - Tempered Glass - 66” High | EVPGPT6618 | 1078 | 66 | 18 | 2 7/8 |
| | | EVPGPT6624 | 1326 | 66 | 24 | 2 7/8 |
| | | EVPGPT6630 | 1467 | 66 | 30 | 2 7/8 |
| | | EVPGPT6636 | 1595 | 66 | 36 | 2 7/8 |
| | | EVPGPT6642 | 1771 | 66 | 42 | 2 7/8 |
| | | EVPGPT6648 | 1972 | 66 | 48 | 2 7/8 |
| | | EVPGPT6654 | 2176 | 66 | 54 | 2 7/8 |
| | | EVPGPT6660 | 2379 | 66 | 60 | 2 7/8 |

EVPLGPT - FULLY GLAZED PREMIUM LIGHT PANEL - TEMPERED GLASS

- Fully Glazed Premium Light Panel incorporates 12”H Glazed Modules into a solid steel frame.
- There is no base raceway in Light Panels to accommodate electrical.
- Light Panel Connectors must be used in conjunction with Light Panels.
- An aluminum low profile top cap is included.
- Stackability: Evolve panels can be increased in height in 6”H, 12”H, 18”H or 24”H increments. See Extension Modules for part numbers.
- Standard in clear (CLR) glass.
- Frosted glass (FRST) 40% upcharge.

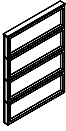
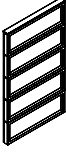
| | DESCRIPTION | PRODUCT CODE | LIST PRICE | DIMENSIONS/INCHES | | |
|--|--|--------------|------------|-------------------|----|-------|
| | | | | H | W | D |
|  | Fully Glazed Premium Light Panel - Tempered Glass - 42” High | EVPLGPT4218 | 682 | 42 | 18 | 2 7/8 |
| | | EVPLGPT4224 | 834 | 42 | 24 | 2 7/8 |
| | | EVPLGPT4230 | 923 | 42 | 30 | 2 7/8 |
| | | EVPLGPT4236 | 1009 | 42 | 36 | 2 7/8 |
| | | EVPLGPT4242 | 1119 | 42 | 42 | 2 7/8 |
| | | EVPLGPT4248 | 1243 | 42 | 48 | 2 7/8 |
| | | EVPLGPT4254 | 1371 | 42 | 54 | 2 7/8 |
| | | EVPLGPT4260 | 1493 | 42 | 60 | 2 7/8 |
|  | Fully Glazed Premium Light Panel - Tempered Glass - 54” High | EVPLGPT5418 | 866 | 54 | 18 | 2 7/8 |
| | | EVPLGPT5424 | 1062 | 54 | 24 | 2 7/8 |
| | | EVPLGPT5430 | 1171 | 54 | 30 | 2 7/8 |
| | | EVPLGPT5436 | 1280 | 54 | 36 | 2 7/8 |
| | | EVPLGPT5442 | 1422 | 54 | 42 | 2 7/8 |
| | | EVPLGPT5448 | 1581 | 54 | 48 | 2 7/8 |
| | | EVPLGPT5454 | 1741 | 54 | 54 | 2 7/8 |
| | | EVPLGPT5460 | 1900 | 54 | 60 | 2 7/8 |
|  | Fully Glazed Premium Light Panel - Tempered Glass - 66” High | EVPLGPT6618 | 1048 | 66 | 18 | 2 7/8 |
| | | EVPLGPT6624 | 1285 | 66 | 24 | 2 7/8 |
| | | EVPLGPT6630 | 1424 | 66 | 30 | 2 7/8 |
| | | EVPLGPT6636 | 1546 | 66 | 36 | 2 7/8 |
| | | EVPLGPT6642 | 1720 | 66 | 42 | 2 7/8 |
| | | EVPLGPT6648 | 1914 | 66 | 48 | 2 7/8 |
| | | EVPLGPT6654 | 2109 | 66 | 54 | 2 7/8 |
| | | EVPLGPT6660 | 2307 | 66 | 60 | 2 7/8 |



EVPHSG - RECEPTION PANEL LAMINATE

- Reception panel incorporates glazed module and pass thru module within steel frame. Glazing is clear only.
- 6" H or 12" H pass thru with sliding glass door module.
- 24" H Laminate bottom module.
- Aluminum low profile top is included.
- Stackability: Evolve panels can be increased in height in 6", 12", 24" increments. See module listing for part numbers.

| | DESCRIPTION | PRODUCT CODE | LIST PRICE | DIMENSIONS/INCHES | | |
|---|--------------------------------------|--------------|------------|-------------------|----|-------|
| | | | | H | W | D |
|  | Reception Panel with 12" H Pass Thru | EVPHSG2M6636 | 1444 | 66 | 36 | 2 7/8 |
| | | EVPHSG2M6642 | 1561 | 66 | 42 | 2 7/8 |
| | | EVPHSG2M6648 | 1688 | 66 | 48 | 2 7/8 |

EVPHSG - RECEPTION PANEL LAMINATE

- Reception panel incorporates glazed module and pass thru module within steel frame. Glazing is clear only.
- 6" H pass thru with sliding glass door module.
- 30" H Laminate bottom module.
- Aluminum low profile top is included.
- Stackability: Evolve panels can be increased in height in 6", 12", 24" increments. See module listing for part numbers.

| | DESCRIPTION | PRODUCT CODE | LIST PRICE | DIMENSIONS/INCHES | | |
|--|-------------------------------------|--------------|------------|-------------------|----|-------|
| | | | | H | W | D |
|  | Reception Panel with 6" H Pass Thru | EVPHSG3M6636 | 1499 | 66 | 36 | 2 7/8 |
| | | EVPHSG3M6642 | 1611 | 66 | 42 | 2 7/8 |
| | | EVPHSG3M6648 | 1764 | 66 | 48 | 2 7/8 |

EVPHSG - RECEPTION PANEL LAMINATE

- Reception panel incorporates glazed module and pass thru module within steel frame. Glazing is clear only.
- 6" H or 12" H pass thru with sliding glass door module.
- 24" H Laminate bottom module.
- Aluminum low profile top is included.
- Stackability: Evolve panels can be increased in height in 6", 12", 24" increments. See module listing for part numbers.

| | DESCRIPTION | PRODUCT CODE | LIST PRICE | DIMENSIONS/INCHES | | |
|---|-------------------------------------|--------------|------------|-------------------|----|-------|
| | | | | H | W | D |
|  | Reception Panel with 6" H Pass Thru | EVPHSG5M6636 | 1477 | 66 | 36 | 2 7/8 |
| | | EVPHSG5M6642 | 1595 | 66 | 42 | 2 7/8 |
| | | EVPHSG5M6648 | 1722 | 66 | 48 | 2 7/8 |

EVPHSG - RECEPTION PANEL FABRIC

- Reception panel incorporates glazed module and pass thru module within steel frame. Glazing is clear only.
- 6" H or 12" H pass thru with sliding glass door module.
- 24" H Fabric bottom module.
- Aluminum low profile top is included.
- Stackability: Evolve panels can be increased in height in 6", 12", 24" increments. See module listing for part numbers.

| | DESCRIPTION | PRODUCT CODE | LIST PRICE | | DIMENSIONS/INCHES | | |
|---|--------------------------------------|--------------|------------|------|-------------------|----|-------|
| | | | Gr1 | Gr2 | H | W | D |
|  | Reception Panel with 12" H Pass Thru | EVPHSG2M6636 | 1291 | 1319 | 66 | 36 | 2 7/8 |
| | | EVPHSG2M6642 | 1422 | 1457 | 66 | 42 | 2 7/8 |
| | | EVPHSG2M6648 | 1566 | 1601 | 66 | 48 | 2 7/8 |

EVPHSG - RECEPTION PANEL FABRIC

- Reception panel incorporates glazed module and pass thru module within steel frame. Glazing is clear only.
- 6" H pass thru with sliding glass door module.
- 30" H Fabric bottom module.
- Aluminum low profile top is included.
- Stackability: Evolve panels can be increased in height in 6", 12", 24" increments. See module listing for part numbers.

| | DESCRIPTION | PRODUCT CODE | LIST PRICE | | DIMENSIONS/INCHES | | |
|--|-------------------------------------|--------------|------------|------|-------------------|----|-------|
| | | | Gr1 | Gr2 | H | W | D |
|  | Reception Panel with 6" H Pass Thru | EVPHSG3M6636 | 1362 | 1391 | 66 | 36 | 2 7/8 |
| | | EVPHSG3M6642 | 1485 | 1520 | 66 | 42 | 2 7/8 |
| | | EVPHSG3M6648 | 1611 | 1646 | 66 | 48 | 2 7/8 |

EVPHSG - RECEPTION PANEL FABRIC

- Reception panel incorporates glazed module and pass thru module within steel frame. Glazing is clear only.
- 6" H or 12" H pass thru with sliding glass door module.
- 24" H Fabric bottom module.
- Aluminum low profile top is included.
- Stackability: Evolve panels can be increased in height in 6", 12", 24" increments. See module listing for part numbers.

| | DESCRIPTION | PRODUCT CODE | LIST PRICE | | DIMENSIONS/INCHES | | |
|---|-------------------------------------|--------------|------------|------|-------------------|----|-------|
| | | | Gr1 | Gr2 | H | W | D |
|  | Reception Panel with 6" H Pass Thru | EVPHSG5M6636 | 1313 | 1342 | 66 | 36 | 2 7/8 |
| | | EVPHSG5M6642 | 1462 | 1495 | 66 | 42 | 2 7/8 |
| | | EVPHSG5M6648 | 1609 | 1644 | 66 | 48 | 2 7/8 |

EVSLs - LAMINATED SHELF FOR RECEPTION PANEL

- Laminated Wood Shelf Panel Mounted.
- Shelf thickness 1".
- Available in LP.
- Includes attachment hardware.

| | DESCRIPTION | PRODUCT CODE | LIST PRICE | DIMENSIONS/INCHES | | |
|---|-----------------------|--------------|------------|-------------------|----|----|
| | | | | H | W | D |
|  | Reception Panel Shelf | EVSLs1218 | 258 | 1.125 | 18 | 12 |
| | | EVSLs1224 | 277 | 1.125 | 24 | 12 |
| | | EVSLs1230 | 294 | 1.125 | 30 | 12 |
| | | EVSLs1236 | 313 | 1.125 | 36 | 12 |
| | | EVSLs1242 | 330 | 1.125 | 42 | 12 |
| | | EVSLs1248 | 349 | 1.125 | 48 | 12 |



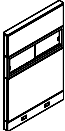
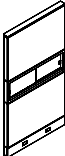
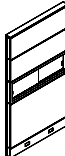

EVPFSG - PASS-THRU SLIDING DOOR GLAZED PANEL - TEMPERED GLASS

- Pass-Thru Sliding Door Glazed Panel incorporates fabric modules on upper and lower positions, with Middle 12”H Pass-Thru Sliding Door module, into a solid steel frame.
- Tracks for Sliding glass door available in Tungsten only.
- Opposite sides of each panel may have a different fabric within the same grade at no upcharge.
- If different grades of fabric are used on one panel, the entire panel must be priced at highest grade.
- An aluminum low profile top cap is included.
- Stackability: Evolve panels can be increased in height in 6”H, 12”H, 18”H or 24”H increments. See Extension Modules for part numbers.
- Standard in clear (CLR) glass.
- Frosted glass (FRST) 20% upcharge.

| | DESCRIPTION | PRODUCT CODE | LIST PRICE | | DIMENSIONS/INCHES | | |
|--|---|--------------|------------|------|-------------------|----|-------|
| | | | Gr1 | Gr2 | H | W | D |
|  | Pass-Thru Sliding Door Glazed Panel - Tempered Glass - 54” High | EVPFSG5424 | 717 | 746 | 54 | 24 | 2 7/8 |
| | | EVPFSG5430 | 810 | 847 | 54 | 30 | 2 7/8 |
| | | EVPFSG5436 | 911 | 954 | 54 | 36 | 2 7/8 |
| | | EVPFSG5442 | 1022 | 1072 | 54 | 42 | 2 7/8 |
| | | EVPFSG5448 | 1111 | 1162 | 54 | 48 | 2 7/8 |
| | | EVPFSG5454 | 1246 | 1304 | 54 | 54 | 2 7/8 |
| | | EVPFSG5460 | 1377 | 1444 | 54 | 60 | 2 7/8 |
|  | Pass-Thru Sliding Door Glazed Panel - Tempered Glass - 66” High | EVPFSG6624 | 775 | 814 | 66 | 24 | 2 7/8 |
| | | EVPFSG6630 | 885 | 930 | 66 | 30 | 2 7/8 |
| | | EVPFSG6636 | 989 | 1048 | 66 | 36 | 2 7/8 |
| | | EVPFSG6642 | 1118 | 1179 | 66 | 42 | 2 7/8 |
| | | EVPFSG6648 | 1213 | 1282 | 66 | 48 | 2 7/8 |
| | | EVPFSG6654 | 1355 | 1432 | 66 | 54 | 2 7/8 |
| | | EVPFSG6660 | 1525 | 1578 | 66 | 60 | 2 7/8 |
|  | Pass-Thru Sliding Door Glazed Panel - Tempered Glass - 66” High | EVPPFSG6624 | 775 | 814 | 66 | 24 | 2 7/8 |
| | | EVPPFSG6630 | 885 | 930 | 66 | 30 | 2 7/8 |
| | | EVPPFSG6636 | 989 | 1048 | 66 | 36 | 2 7/8 |
| | | EVPPFSG6642 | 1118 | 1179 | 66 | 42 | 2 7/8 |
| | | EVPPFSG6648 | 1213 | 1282 | 66 | 48 | 2 7/8 |
| | | EVPPFSG6654 | 1355 | 1432 | 66 | 54 | 2 7/8 |
| | | EVPPFSG6660 | 1525 | 1578 | 66 | 60 | 2 7/8 |

EVPFSGX - FABRIC GLAZED PASS-THRU SLIDING DOOR PANEL - TEMPERED GLASS

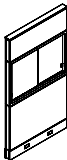

- Pass-Thru Sliding Door Glazed Panel incorporates fabric modules with 12”H or 24”H Pass-Thru Sliding Door module, into a solid steel frame.
- Tracks for Sliding glass door available in Tungsten only.
- Opposite sides of each panel may have a different fabric within the same grade at no upcharge.
- If different grades of fabric are used on one panel, the entire panel must be priced at highest grade.
- An aluminum low profile top cap is included.
- Stackability: Evolve panels can be increased in height in 6”H, 12”H, 18”H or 24”H increments. See Extension Modules for part numbers.
- Standard in clear (CLR) glass.
- Frosted glass (FRST) 20% upcharge.

| | DESCRIPTION | PRODUCT CODE | LIST PRICE | | DIMENSIONS/INCHES | | |
|--|--|--------------|------------|------|-------------------|----|-------|
| | | | Gr1 | Gr2 | H | W | D |
|  | Fabric Glazed Pass-Thru Sliding Door Panel - Tempered Glass - 42” High | EVPFSGX4224 | 556 | 575 | 42 | 24 | 2 7/8 |
| | | EVPFSGX4230 | 629 | 652 | 42 | 30 | 2 7/8 |
| | | EVPFSGX4236 | 702 | 730 | 42 | 36 | 2 7/8 |
| | | EVPFSGX4242 | 780 | 813 | 42 | 42 | 2 7/8 |
| | | EVPFSGX4248 | 854 | 887 | 42 | 48 | 2 7/8 |
| | | EVPFSGX4254 | 954 | 989 | 42 | 54 | 2 7/8 |
| | | EVPFSGX4260 | 1053 | 1095 | 42 | 60 | 2 7/8 |
|  | Fabric Glazed Pass-Thru Sliding Door Panel - Tempered Glass - 54” High | EVPFSGX5424 | 604 | 625 | 54 | 24 | 2 7/8 |
| | | EVPFSGX5430 | 702 | 725 | 54 | 30 | 2 7/8 |
| | | EVPFSGX5436 | 796 | 824 | 54 | 36 | 2 7/8 |
| | | EVPFSGX5442 | 889 | 921 | 54 | 42 | 2 7/8 |
| | | EVPFSGX5448 | 970 | 1006 | 54 | 48 | 2 7/8 |
| | | EVPFSGX5454 | 1124 | 1162 | 54 | 54 | 2 7/8 |
| | | EVPFSGX5460 | 1276 | 1324 | 54 | 60 | 2 7/8 |
|  | Fabric Glazed Pass-Thru Sliding Door Panel - Tempered Glass - 66” High | EVPFSGX6624 | 767 | 797 | 66 | 24 | 2 7/8 |
| | | EVPFSGX6630 | 885 | 920 | 66 | 30 | 2 7/8 |
| | | EVPFSGX6636 | 1007 | 1048 | 66 | 36 | 2 7/8 |
| | | EVPFSGX6642 | 1131 | 1182 | 66 | 42 | 2 7/8 |
| | | EVPFSGX6648 | 1229 | 1282 | 66 | 48 | 2 7/8 |
| | | EVPFSGX6654 | 1414 | 1473 | 66 | 54 | 2 7/8 |
| | | EVPFSGX6660 | 1600 | 1666 | 66 | 60 | 2 7/8 |

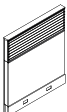

EVPF1S - SLATWALL PANEL - SINGLE SIDED

- Slatwall Panel incorporates fabric modules with a single 12”H or 24”H top position slatwall module, into a solid steel frame.
- 66”H panel can be configured with either a 24”H slatwall module at the top or a 12”H slatwall at the middle Position (EVPF1S66xxM)
- Opposite side is fabric covered.
- Slatwall is made of aluminum.
- Accessories can be used on slatwall modules. Please see accessory section for additional details.
- Opposite sides of each panel may have a different fabric within the same grade at no upcharge.
- If different grades of fabric are used on one panel, the entire panel must be priced at highest grade.
- An aluminum low profile top cap is included.
- Stackability: Evolve panels can be increased in height in 6”H, 12”H, 18”H or 24”H increments. See Extension Modules for part numbers.

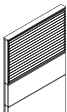
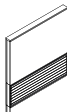
| | DESCRIPTION | PRODUCT CODE | LIST PRICE | | DIMENSIONS/INCHES | | |
|---|---|--------------|------------|------|-------------------|----|-------|
| | | | Gr1 | Gr2 | H | W | D |
|  | Slatwall Panel - Single Sided - 42” High | EVPF1S4218 | 525 | 546 | 42 | 18 | 2 7/8 |
| | | EVPF1S4224 | 626 | 654 | 42 | 24 | 2 7/8 |
| | | EVPF1S4230 | 734 | 765 | 42 | 30 | 2 7/8 |
| | | EVPF1S4236 | 839 | 875 | 42 | 36 | 2 7/8 |
| | | EVPF1S4242 | 954 | 992 | 42 | 42 | 2 7/8 |
| | | EVPF1S4248 | 1037 | 1084 | 42 | 48 | 2 7/8 |
| | | EVPF1S4254 | 1152 | 1200 | 42 | 54 | 2 7/8 |
| | | EVPF1S4260 | 1260 | 1317 | 42 | 60 | 2 7/8 |
|  | Slatwall Panel - Single Sided - 54” High | EVPF1S5418 | 618 | 643 | 54 | 18 | 2 7/8 |
| | | EVPF1S5424 | 744 | 774 | 54 | 24 | 2 7/8 |
| | | EVPF1S5430 | 869 | 907 | 54 | 30 | 2 7/8 |
| | | EVPF1S5436 | 1000 | 1039 | 54 | 36 | 2 7/8 |
| | | EVPF1S5442 | 1129 | 1180 | 54 | 42 | 2 7/8 |
| | | EVPF1S5448 | 1231 | 1288 | 54 | 48 | 2 7/8 |
| | | EVPF1S5454 | 1372 | 1433 | 54 | 54 | 2 7/8 |
| | | EVPF1S5460 | 1509 | 1570 | 54 | 60 | 2 7/8 |
|  | Slatwall Panel - Single Sided - 66” High | EVPF1S6618 | 785 | 813 | 66 | 18 | 2 7/8 |
| | | EVPF1S6624 | 942 | 986 | 66 | 24 | 2 7/8 |
| | | EVPF1S6630 | 1104 | 1154 | 66 | 30 | 2 7/8 |
| | | EVPF1S6636 | 1272 | 1322 | 66 | 36 | 2 7/8 |
| | | EVPF1S6642 | 1446 | 1512 | 66 | 42 | 2 7/8 |
| | | EVPF1S6648 | 1573 | 1637 | 66 | 48 | 2 7/8 |
| | | EVPF1S6654 | 1752 | 1822 | 66 | 54 | 2 7/8 |
| | | EVPF1S6660 | 1930 | 2007 | 66 | 60 | 2 7/8 |
|  | Slat Wall Panel - Single Sided - Middle Module - 66” High | EVPF1S6618M | 765 | 800 | 66 | 18 | 2 7/8 |
| | | EVPF1S6624M | 920 | 966 | 66 | 24 | 2 7/8 |
| | | EVPF1S6630M | 1073 | 1127 | 66 | 30 | 2 7/8 |
| | | EVPF1S6636M | 1235 | 1299 | 66 | 36 | 2 7/8 |
| | | EVPF1S6642M | 1406 | 1480 | 66 | 42 | 2 7/8 |
| | | EVPF1S6648M | 1531 | 1612 | 66 | 48 | 2 7/8 |
| | | EVPF1S6654M | 1702 | 1793 | 66 | 54 | 2 7/8 |
| | | EVPF1S6660M | 1873 | 1972 | 66 | 60 | 2 7/8 |

EVPLF1S - SLATWALL LIGHT PANEL - SINGLE SIDED

- Slatwall Light Panel incorporates fabric modules with a single 12”H or 24”H top position slatwall module, into a solid steel frame.
- 66”H panel can be configured with either a 24”H slatwall module at the top or a 12”H slatwall at the middle Position (EVPLF1S66xxM)
- Opposite side is fabric covered
- Slatwall is made of aluminum.
- Accessories can be used on slatwall modules. Please see accessory section for additional details.
- There is no base raceway in Light Panels to accommodate electrical.
- Light Panel Connectors must be used in conjunction with Light Panels.
- Opposite sides of each panel may have a different fabric within the same grade at no upcharge.
- If different grades of fabric are used on one panel, the entire panel must be priced at highest grade.
- An aluminum low profile top cap is included.
- Stackability: Evolve panels can be increased in height in 6”H, 12”H, 18”H or 24”H increments. See Extension Modules for part numbers.

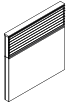
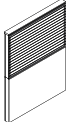
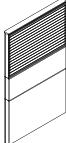
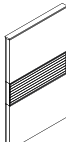
| | DESCRIPTION | PRODUCT CODE | LIST PRICE | | DIMENSIONS/INCHES | | |
|---|--|--------------|------------|------|-------------------|----|-------|
| | | | Gr1 | Gr2 | H | W | D |
|  | Slatwall Light Panel - Single Sided- 42” High | EVPLF1S4218 | 513 | 534 | 42 | 18 | 2 7/8 |
| | | EVPLF1S4224 | 613 | 641 | 42 | 24 | 2 7/8 |
| | | EVPLF1S4230 | 718 | 747 | 42 | 30 | 2 7/8 |
| | | EVPLF1S4236 | 824 | 857 | 42 | 36 | 2 7/8 |
| | | EVPLF1S4242 | 932 | 972 | 42 | 42 | 2 7/8 |
| | | EVPLF1S4248 | 1017 | 1060 | 42 | 48 | 2 7/8 |
| | | EVPLF1S4254 | 1127 | 1175 | 42 | 54 | 2 7/8 |
| | | EVPLF1S4260 | 1235 | 1290 | 42 | 60 | 2 7/8 |
|  | Slatwall Light Panel - Single Sided - 54” High | EVPLF1S5418 | 605 | 626 | 54 | 18 | 2 7/8 |
| | | EVPLF1S5424 | 730 | 757 | 54 | 24 | 2 7/8 |
| | | EVPLF1S5430 | 854 | 887 | 54 | 30 | 2 7/8 |
| | | EVPLF1S5436 | 978 | 1018 | 54 | 36 | 2 7/8 |
| | | EVPLF1S5442 | 1107 | 1154 | 54 | 42 | 2 7/8 |
| | | EVPLF1S5448 | 1210 | 1262 | 54 | 48 | 2 7/8 |
| | | EVPLF1S5454 | 1345 | 1403 | 54 | 54 | 2 7/8 |
| | | EVPLF1S5460 | 1479 | 1535 | 54 | 60 | 2 7/8 |
|  | Slatwall Light Panel - Single Sided - 66” High | EVPLF1S6618 | 770 | 796 | 66 | 18 | 2 7/8 |
| | | EVPLF1S6624 | 923 | 965 | 66 | 24 | 2 7/8 |
| | | EVPLF1S6630 | 1081 | 1127 | 66 | 30 | 2 7/8 |
| | | EVPLF1S6636 | 1246 | 1294 | 66 | 36 | 2 7/8 |
| | | EVPLF1S6642 | 1417 | 1479 | 66 | 42 | 2 7/8 |
| | | EVPLF1S6648 | 1540 | 1604 | 66 | 48 | 2 7/8 |
| | | EVPLF1S6654 | 1714 | 1781 | 66 | 54 | 2 7/8 |
| | | EVPLF1S6660 | 1892 | 1965 | 66 | 60 | 2 7/8 |
|  | Slatwall Light Panel - Single Sided - Middle Module - 66” High | EVPLF1S6618M | 747 | 779 | 66 | 18 | 2 7/8 |
| | | EVPLF1S6624M | 902 | 942 | 66 | 24 | 2 7/8 |
| | | EVPLF1S6630M | 1053 | 1103 | 66 | 30 | 2 7/8 |
| | | EVPLF1S6636M | 1213 | 1273 | 66 | 36 | 2 7/8 |
| | | EVPLF1S6642M | 1378 | 1448 | 66 | 42 | 2 7/8 |
| | | EVPLF1S6648M | 1500 | 1577 | 66 | 48 | 2 7/8 |
| | | EVPLF1S6654M | 1669 | 1757 | 66 | 54 | 2 7/8 |
| | | EVPLF1S6660M | 1835 | 1931 | 66 | 60 | 2 7/8 |



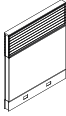
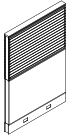
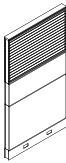
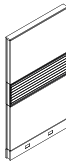

EVPF2S - SLATWALL PANEL - DOUBLE SIDED

- Slatwall Panel incorporates fabric modules with a single 12”H or 24”H top position slatwall module, into a solid steel frame.
- 66”H panel can be configured with either a 24”H slatwall module at the top or a 12”H slatwall at the middle Position (EVPF2S66xxM)
- Slatwall module has slatwall on both sides.
- Slatwall is made of aluminum.
- Accessories can be used on slatwall modules. Please see accessory section for additional details.
- Opposite sides of each panel may have a different fabric within the same grade at no upcharge.
- If different grades of fabric are used on one panel, the entire panel must be priced at highest grade.
- An aluminum low profile top cap is included.
- Stackability: Evolve panels can be increased in height in 6”H, 12”H, 18”H or 24”H increments. See Extension Modules for part numbers.

| | DESCRIPTION | PRODUCT CODE | LIST PRICE | | DIMENSIONS/INCHES | | |
|---|--|--------------|------------|------|-------------------|----|-------|
| | | | Gr1 | Gr2 | H | W | D |
|  | Slatwall Panel - Double Sided - 42” High | EVPF2S4218 | 588 | 605 | 42 | 18 | 2 7/8 |
| | | EVPF2S4224 | 710 | 734 | 42 | 24 | 2 7/8 |
| | | EVPF2S4230 | 835 | 863 | 42 | 30 | 2 7/8 |
| | | EVPF2S4236 | 974 | 1005 | 42 | 36 | 2 7/8 |
| | | EVPF2S4242 | 1111 | 1144 | 42 | 42 | 2 7/8 |
| | | EVPF2S4248 | 1243 | 1281 | 42 | 48 | 2 7/8 |
| | | EVPF2S4254 | 1369 | 1408 | 42 | 54 | 2 7/8 |
| | | EVPF2S4260 | 1488 | 1537 | 42 | 60 | 2 7/8 |
|  | Slatwall Panel - Double Sided - 54” High | EVPF2S5418 | 686 | 704 | 54 | 18 | 2 7/8 |
| | | EVPF2S5424 | 840 | 866 | 54 | 24 | 2 7/8 |
| | | EVPF2S5430 | 992 | 1019 | 54 | 30 | 2 7/8 |
| | | EVPF2S5436 | 1158 | 1188 | 54 | 36 | 2 7/8 |
| | | EVPF2S5442 | 1325 | 1358 | 54 | 42 | 2 7/8 |
| | | EVPF2S5448 | 1487 | 1525 | 54 | 48 | 2 7/8 |
| | | EVPF2S5454 | 1636 | 1677 | 54 | 54 | 2 7/8 |
| | | EVPF2S5460 | 1781 | 1829 | 54 | 60 | 2 7/8 |
|  | Slatwall Panel - Double Sided - 66” High | EVPF2S6618 | 889 | 914 | 66 | 18 | 2 7/8 |
| | | EVPF2S6624 | 1094 | 1125 | 66 | 24 | 2 7/8 |
| | | EVPF2S6630 | 1295 | 1333 | 66 | 30 | 2 7/8 |
| | | EVPF2S6636 | 1503 | 1546 | 66 | 36 | 2 7/8 |
| | | EVPF2S6642 | 1721 | 1771 | 66 | 42 | 2 7/8 |
| | | EVPF2S6648 | 1930 | 1985 | 66 | 48 | 2 7/8 |
| | | EVPF2S6654 | 2131 | 2189 | 66 | 54 | 2 7/8 |
| | | EVPF2S6660 | 2325 | 2394 | 66 | 60 | 2 7/8 |
|  | Slatwall Panel - Double Sided - Middle Module - 66” High | EVPF2S6618M | 866 | 897 | 66 | 18 | 2 7/8 |
| | | EVPF2S6624M | 1063 | 1106 | 66 | 24 | 2 7/8 |
| | | EVPF2S6630M | 1260 | 1309 | 66 | 30 | 2 7/8 |
| | | EVPF2S6636M | 1463 | 1517 | 66 | 36 | 2 7/8 |
| | | EVPF2S6642M | 1671 | 1733 | 66 | 42 | 2 7/8 |
| | | EVPF2S6648M | 1873 | 1948 | 66 | 48 | 2 7/8 |
| | | EVPF2S6654M | 2072 | 2149 | 66 | 54 | 2 7/8 |
| | | EVPF2S6660M | 2263 | 2350 | 66 | 60 | 2 7/8 |

EVPLF2S - SLATWALL LIGHT PANEL - DOUBLE SIDED

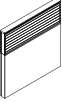
- Slatwall Light Panel incorporates fabric modules with a single 12”H or 24”H top position slatwall module, into a solid steel frame.
- 66”H panel can be configured with either a 24”H slatwall module at the top or a 12”H slatwall at the middle Position (EVPLF2S66xxM)
- Slatwall module has slatwall on both sides.
- Slatwall is made of aluminum.
- Accessories can be used on slatwall modules. Please see accessory section for additional details.
- There is no base raceway in Light Panels to accommodate electrical.
- Light Panel Connectors must be used in conjunction with Light Panels.
- Opposite sides of each panel may have a different fabric within the same grade at no upcharge.
- If different grades of fabric are used on one panel, the entire panel must be priced at highest grade.
- An aluminum low profile top cap is included.
- Stackability: Evolve panels can be increased in height in 6”H, 12”H, 18”H or 24”H increments.
- See Extension Modules for part numbers.

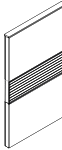
| | DESCRIPTION | PRODUCT CODE | LIST PRICE | | DIMENSIONS/INCHES | | |
|---|--|--------------|------------|------|-------------------|-------|-------|
| | | | Gr1 | Gr2 | H | W | D |
|  | Slatwall Light Panel - Double Sided - 42" High | EVPLF2S4218 | 576 | 592 | 42 | 18 | 2 7/8 |
| | | EVPLF2S4224 | 696 | 715 | 42 | 24 | 2 7/8 |
| | | EVPLF2S4230 | 821 | 842 | 42 | 30 | 2 7/8 |
| | | EVPLF2S4236 | 956 | 983 | 42 | 36 | 2 7/8 |
| | | EVPLF2S4242 | 1088 | 1120 | 42 | 42 | 2 7/8 |
| | | EVPLF2S4248 | 1219 | 1253 | 42 | 48 | 2 7/8 |
| | | EVPLF2S4254 | 1341 | 1378 | 42 | 54 | 2 7/8 |
| | EVPLF2S4260 | 1457 | 1503 | 42 | 60 | 2 7/8 | |
|  | Slatwall Light Panel - Double Sided - 54" High | EVPLF2S5418 | 674 | 686 | 54 | 18 | 2 7/8 |
| | | EVPLF2S5424 | 827 | 844 | 54 | 24 | 2 7/8 |
| | | EVPLF2S5430 | 974 | 999 | 54 | 30 | 2 7/8 |
| | | EVPLF2S5436 | 1135 | 1161 | 54 | 36 | 2 7/8 |
| | | EVPLF2S5442 | 1296 | 1328 | 54 | 42 | 2 7/8 |
| | | EVPLF2S5448 | 1456 | 1490 | 54 | 48 | 2 7/8 |
| | | EVPLF2S5454 | 1604 | 1639 | 54 | 54 | 2 7/8 |
| | EVPLF2S5460 | 1746 | 1790 | 54 | 60 | 2 7/8 | |
|  | Slatwall Light Panel - Double Sided - 66" High | EVPLF2S6618 | 872 | 896 | 66 | 18 | 2 7/8 |
| | | EVPLF2S6624 | 1072 | 1103 | 66 | 24 | 2 7/8 |
| | | EVPLF2S6630 | 1272 | 1306 | 66 | 30 | 2 7/8 |
| | | EVPLF2S6636 | 1473 | 1514 | 66 | 36 | 2 7/8 |
| | | EVPLF2S6642 | 1687 | 1732 | 66 | 42 | 2 7/8 |
| | | EVPLF2S6648 | 1892 | 1940 | 66 | 48 | 2 7/8 |
| | | EVPLF2S6654 | 2086 | 2143 | 66 | 54 | 2 7/8 |
| | EVPLF2S6660 | 2280 | 2343 | 66 | 60 | 2 7/8 | |
|  | Slatwall Light Panel - Double Sided - 66" High | EVPLF2S6618M | 840 | 878 | 66 | 18 | 2 7/8 |
| | | EVPLF2S6624M | 1042 | 1081 | 66 | 24 | 2 7/8 |
| | | EVPLF2S6630M | 1235 | 1281 | 66 | 30 | 2 7/8 |
| | | EVPLF2S6636M | 1433 | 1484 | 66 | 36 | 2 7/8 |
| | | EVPLF2S6642M | 1638 | 1699 | 66 | 42 | 2 7/8 |
| | | EVPLF2S6648M | 1835 | 1903 | 66 | 48 | 2 7/8 |
| | | EVPLF2S6654M | 2030 | 2105 | 66 | 54 | 2 7/8 |
| | EVPLF2S6660M | 2219 | 2304 | 66 | 60 | 2 7/8 | |



EVPBSFA - FRAMELESS SLATWALL BELTLINE POWERED PANEL - DOUBLE SIDED ONLY

- Frameless Slatwall Beltline Powered Panel incorporates fabric modules with a single 6”H slatwall module above a power beltline raceway, into a solid steel frame.
- Slatwall module has slatwall on both sides only, and is not available Single Sided.
- Slatwall is made of aluminum.
- Slatwall is not encompassed within a frame.
- A Chimney Panel is required to run electric and data from the base to belt
- 6”H power beltline raceway, to accommodate electrical, is metal with knockouts on both sides.
- Beltline Connectors must be used in conjunction with beltline panels.
- Accessories can be used on slatwall modules. Please see accessory section for additional details.
- Opposite sides of each panel may have a different fabric within the same grade at no upcharge.
- If different grades of fabric are used on one panel, the entire panel must be priced at highest grade.
- An aluminum low profile top cap is included.
- Stackability: Evolve panels can be increased in height in 6”H, 12”H, 18”H or 24”H increments. See Extension Modules for part numbers.

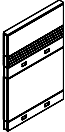
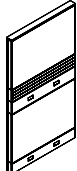
| | DESCRIPTION | PRODUCT CODE | LIST PRICE | | DIMENSIONS/INCHES | | |
|--|--|--------------|------------|------|-------------------|----|-------|
| | | | Gr1 | Gr2 | H | W | D |
|  | Frameless Slatwall Beltline Powered Panel - Double Sided Only - 42” High | EVPBSFA4224 | 520 | 541 | 42 | 24 | 2 7/8 |
| | | EVPBSFA4230 | 605 | 627 | 42 | 30 | 2 7/8 |
| | | EVPBSFA4236 | 706 | 732 | 42 | 36 | 2 7/8 |
| | | EVPBSFA4242 | 794 | 824 | 42 | 42 | 2 7/8 |
| | | EVPBSFA4248 | 874 | 938 | 42 | 48 | 2 7/8 |
| | | EVPBSFA4254 | 961 | 1001 | 42 | 54 | 2 7/8 |
| | | EVPBSFA4260 | 1044 | 1088 | 42 | 60 | 2 7/8 |
|  | Frameless Slatwall Beltline Powered Panel - Double Sided Only - 54” High | EVPBSFA5424 | 657 | 686 | 54 | 24 | 2 7/8 |
| | | EVPBSFA5430 | 765 | 799 | 54 | 30 | 2 7/8 |
| | | EVPBSFA5436 | 902 | 941 | 54 | 36 | 2 7/8 |
| | | EVPBSFA5442 | 1009 | 1055 | 54 | 42 | 2 7/8 |
| | | EVPBSFA5448 | 1111 | 1163 | 54 | 48 | 2 7/8 |
| | | EVPBSFA5454 | 1207 | 1265 | 54 | 54 | 2 7/8 |
| | | EVPBSFA5460 | 1314 | 1379 | 54 | 60 | 2 7/8 |
|  | Frameless Slatwall Beltline Powered Panel - Double Sided Only - 66” High | EVPBSFA6624 | 733 | 769 | 66 | 24 | 2 7/8 |
| | | EVPBSFA6630 | 849 | 897 | 66 | 30 | 2 7/8 |
| | | EVPBSFA6636 | 981 | 1034 | 66 | 36 | 2 7/8 |
| | | EVPBSFA6642 | 1102 | 1162 | 66 | 42 | 2 7/8 |
| | | EVPBSFA6648 | 1216 | 1286 | 66 | 48 | 2 7/8 |
| | | EVPBSFA6654 | 1333 | 1408 | 66 | 54 | 2 7/8 |
| | | EVPBSFA6660 | 1448 | 1533 | 66 | 60 | 2 7/8 |

EVPBLSFA - FRAMELESS SLATWALL BELTLINE POWERED LIGHT PANEL - DOUBLE SIDED ONLY

- Frameless Slatwall Beltline Powered Light Panel incorporates fabric modules with a single 6”H slatwall module above a power beltline raceway, into a solid steel frame.
- Slatwall module has slatwall on both sides only, and is not available Single Sided.
- Slatwall is made of aluminum.
- Slatwall is not encompassed within a frame.
- 6”H power beltline raceway, to accommodate electrical, is metal with knockouts on both sides.
- There is no base raceway in Light Panels to accommodate electrical.
- Light Beltline Panel Connectors must be used in conjunction with Light Beltline Panels.
- Accessories can be used on slatwall modules. Please see accessory section for additional details.
- Opposite sides of each panel may have a different fabric within the same grade at no upcharge.
- If different grades of fabric are used on one panel, the entire panel must be priced at highest grade.
- An aluminum low profile top cap is included.
- Stackability: Evolve panels can be increased in height in 6”H, 12”H, 18”H or 24”H increments. See Extension Modules for part numbers.

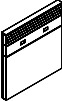
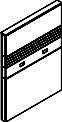
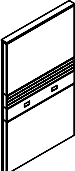
| | DESCRIPTION | PRODUCT CODE | LIST PRICE | | DIMENSIONS/INCHES | | |
|--|--|--------------|------------|------|-------------------|----|-------|
| | | | Gr1 | Gr2 | H | W | D |
|  | Frameless Slatwall Beltline Powered Light Panel - Double Sided Only- 42” High | EVPBLSFA4224 | 497 | 514 | 42 | 24 | 2 7/8 |
| | | EVPBLSFA4230 | 576 | 598 | 42 | 30 | 2 7/8 |
| | | EVPBLSFA4236 | 674 | 699 | 42 | 36 | 2 7/8 |
| | | EVPBLSFA4242 | 753 | 785 | 42 | 42 | 2 7/8 |
| | | EVPBLSFA4248 | 834 | 869 | 42 | 48 | 2 7/8 |
| | | EVPBLSFA4254 | 919 | 957 | 42 | 54 | 2 7/8 |
|  | Frameless Slatwall Beltline Powered Light Panel - Double Sided Only- 54” High | EVPBLSFA5424 | 611 | 641 | 54 | 24 | 2 7/8 |
| | | EVPBLSFA5430 | 667 | 744 | 54 | 30 | 2 7/8 |
| | | EVPBLSFA5436 | 796 | 880 | 54 | 36 | 2 7/8 |
| | | EVPBLSFA5442 | 940 | 984 | 54 | 42 | 2 7/8 |
| | | EVPBLSFA5448 | 1034 | 1088 | 54 | 48 | 2 7/8 |
| | | EVPBLSFA5454 | 1122 | 1182 | 54 | 54 | 2 7/8 |
|  | Frameless Slatwall Beltline Powered Light Panel - Double Sided Only - 66” High | EVPBLSFA6624 | 678 | 714 | 66 | 24 | 2 7/8 |
| | | EVPBLSFA6630 | 784 | 831 | 66 | 30 | 2 7/8 |
| | | EVPBLSFA6636 | 910 | 963 | 66 | 36 | 2 7/8 |
| | | EVPBLSFA6642 | 1018 | 1081 | 66 | 42 | 2 7/8 |
| | | EVPBLSFA6648 | 1124 | 1194 | 66 | 48 | 2 7/8 |
| | | EVPBLSFA6654 | 1234 | 1308 | 66 | 54 | 2 7/8 |
| | | EVPBLSFA6660 | 1341 | 1426 | 66 | 60 | 2 7/8 |



EVPBCSFA - FRAMELESS SLATWALL BELTLINE POWERED CHIMNEY PANEL - DOUBLE SIDED ONLY

- Frameless Slatwall Beltline Powered Chimney Panel incorporates fabric modules with a single 6”H slatwall module above a power beltline raceway, into a solid steel frame.
- Slatwall module has slatwall on both sides only, and is not available Single Sided.
- Slatwall is made of aluminum.
- Slatwall is not encompassed within a frame.
- A Chimney Panel is required to run electric and data from the base to belt.
- Separate electric harness required to go from base to belt (see EVE8CPCP).
- 6”H power beltline raceway, to accommodate electrical, is metal with knockouts on both sides.
- Beltline Connectors must be used in conjunction with beltline panels.
- Accessories can be used on slatwall modules. Please see accessory section for additional details.
- Opposite sides of each panel may have a different fabric within the same grade at no upcharge.
- If different grades of fabric are used on one panel, the entire panel must be priced at highest grade.
- An aluminum low profile top cap is included.
- Stackability: Evolve panels can be increased in height in 6”H, 12”H, 18”H or 24”H increments. See Extension Modules for part numbers.

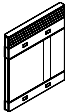
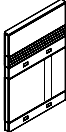
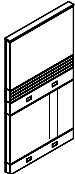
| | DESCRIPTION | PRODUCT CODE | LIST PRICE | | DIMENSIONS/INCHES | | |
|--|--|--------------|------------|------|-------------------|----|-------|
| | | | Gr1 | Gr2 | H | W | D |
|  | Frameless Slatwall Beltline Powered - | EVPBCSFA4236 | 780 | 808 | 42 | 36 | 2 7/8 |
| | Chimney Panel - Double Sided Only - 42” High | EVPBCSFA4242 | 868 | 901 | 42 | 42 | 2 7/8 |
|  | Frameless Slatwall Beltline Powered - | EVPBCSFA5436 | 978 | 1018 | 54 | 36 | 2 7/8 |
| | Chimney Panel - Double Sided Only - 54” High | EVPBCSFA5442 | 1085 | 1130 | 54 | 42 | 2 7/8 |
|  | Frameless Slatwall Beltline Powered - | EVPBCSFA6636 | 1059 | 1111 | 66 | 36 | 2 7/8 |
| | Chimney Panel - Double Sided Only - 66” High | EVPBCSFA6642 | 1176 | 1240 | 66 | 42 | 2 7/8 |

EVE8CPCP - CHIMNEY PANEL JUMPER CABLE KIT

- Contains two (2) 17” flexible harnesses and one (1) “I” connector.
- Used to connect electric from the base to the beltline raceway in Beltline Powered Chimney panel.
- Must use in conjunction with base power distribution harness and beltline power distribution harness (sold separately)

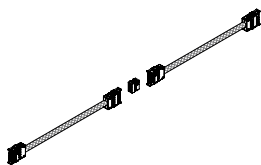

| | DESCRIPTION | PRODUCT CODE | LIST PRICE | DIMENSIONS/INCHES | | |
|--|-------------|--------------|------------|-------------------|---|---|
| | | | | H | W | D |



| | | | | | |
|--------------------------------|----------|-----|--|--|--|
| Chimney Panel Jumper Cable Kit | EVE8CPCP | 341 | | | |
|--------------------------------|----------|-----|--|--|--|



EVPF1W - WRITE BOARD PANEL - SINGLE SIDED

- Write Board Panel incorporates fabric modules with a single 24”H top position write board module, into a solid steel frame.
- Use erasable writeboard markers only.
- Fabric covered modules are tackable and acoustical.
- Opposite sides of each panel may have a different fabric within the same grade at no upcharge.
- If different grades of fabric are used on one panel, the entire panel must be priced at highest grade.
- An aluminum low profile top cap is included.
- Stackability: Evolve panels can be increased in height in 6”H, 12”H, 18”H or 24”H increments. See Extension Modules for part numbers.

| | DESCRIPTION | PRODUCT CODE | LIST PRICE | | DIMENSIONS/INCHES | | |
|---|---|--------------|------------|------|-------------------|----|-------|
| | | | Gr1 | Gr2 | H | W | D |
|  | Write Board Panel - Single Sided - 54” High | EVPF1W5418 | 512 | 530 | 54 | 18 | 2 7/8 |
| | | EVPF1W5424 | 634 | 665 | 54 | 24 | 2 7/8 |
| | | EVPF1W5430 | 766 | 802 | 54 | 30 | 2 7/8 |
| | | EVPF1W5436 | 847 | 890 | 54 | 36 | 2 7/8 |
| | | EVPF1W5442 | 954 | 1004 | 54 | 42 | 2 7/8 |
| | | EVPF1W5448 | 1074 | 1129 | 54 | 48 | 2 7/8 |
| | | EVPF1W5454 | 1194 | 1237 | 54 | 54 | 2 7/8 |
| | | EVPF1W5460 | 1315 | 1381 | 54 | 60 | 2 7/8 |
|  | Write Board Panel - Single Sided - 66” High | EVPF1W6618 | 649 | 676 | 66 | 18 | 2 7/8 |
| | | EVPF1W6624 | 800 | 839 | 66 | 24 | 2 7/8 |
| | | EVPF1W6630 | 950 | 996 | 66 | 30 | 2 7/8 |
| | | EVPF1W6636 | 1058 | 1113 | 66 | 36 | 2 7/8 |
| | | EVPF1W6642 | 1195 | 1260 | 66 | 42 | 2 7/8 |
| | | EVPF1W6648 | 1335 | 1408 | 66 | 48 | 2 7/8 |
| | | EVPF1W6654 | 1484 | 1569 | 66 | 54 | 2 7/8 |
| | | EVPF1W6660 | 1637 | 1727 | 66 | 60 | 2 7/8 |

EVPLF1W - WRITE BOARD LIGHT PANEL - SINGLE SIDED



- Write Board Panel incorporates fabric modules with a single 24”H top position write board module, into a solid steel frame.
- Use erasable writeboard markers only.
- Fabric covered modules are tackable and acoustical.
- Opposite sides of each panel may have a different fabric within the same grade at no upcharge.
- If different grades of fabric are used on one panel, the entire panel must be priced at highest grade.
- Light panel connectors must be used for Light Panels.
- There is no base raceway in Light Panels to accommodate electrical.
- An aluminum low profile top cap is included.
- Stackability: Evolve panels can be increased in height in 6”H, 12”H, 18”H or 24”H increments. See Extension Modules for part numbers.

| | DESCRIPTION | PRODUCT CODE | LIST PRICE | | DIMENSIONS/INCHES | | |
|---|---|--------------|------------|------|-------------------|----|-------|
| | | | Gr1 | Gr2 | H | W | D |
|  | Write Board Light Panel - Single Sided - 54” High | EVPLF1W5418 | 497 | 512 | 54 | 18 | 2 7/8 |
| | | EVPLF1W5424 | 615 | 645 | 54 | 18 | 2 7/8 |
| | | EVPLF1W5430 | 743 | 775 | 54 | 18 | 2 7/8 |
| | | EVPLF1W5436 | 822 | 862 | 54 | 18 | 2 7/8 |
| | | EVPLF1W5442 | 923 | 971 | 54 | 18 | 2 7/8 |
| | | EVPLF1W5448 | 1042 | 1094 | 54 | 18 | 2 7/8 |
| | | EVPLF1W5454 | 1160 | 1195 | 54 | 18 | 2 7/8 |
| | | EVPLF1W5460 | 1276 | 1337 | 54 | 18 | 2 7/8 |
|  | Write Board Light Panel - Single Sided - 66” High | EVPLF1W6618 | 632 | 653 | 66 | 18 | 2 7/8 |
| | | EVPLF1W6624 | 775 | 811 | 66 | 24 | 2 7/8 |
| | | EVPLF1W6630 | 920 | 963 | 66 | 30 | 2 7/8 |
| | | EVPLF1W6636 | 1022 | 1077 | 66 | 36 | 2 7/8 |
| | | EVPLF1W6642 | 1161 | 1220 | 66 | 42 | 2 7/8 |
| | | EVPLF1W6648 | 1294 | 1363 | 66 | 48 | 2 7/8 |
| | | EVPLF1W6654 | 1437 | 1518 | 66 | 54 | 2 7/8 |
| | | EVPLF1W6660 | 1587 | 1671 | 66 | 60 | 2 7/8 |





EVPF2W - WRITE BOARD PANEL - DOUBLE SIDED

- Write Board Panel incorporates fabric modules with a single 24”H top position write board module, into a solid steel frame.
- Use erasable writeboard markers only.
- Opposite sides of each panel may have a different fabric within the same grade at no upcharge.
- If different grades of fabric are used on one panel, the entire panel must be priced at highest grade.
- An aluminum low profile top cap is included.
- Stackability: Evolve panels can be increased in height in 6”H, 12”H, 18”H or 24”H increments. See Extension Modules for part numbers.

| | DESCRIPTION | PRODUCT CODE | LIST PRICE | | DIMENSIONS/INCHES | | |
|---|---|--------------|------------|------|-------------------|----|-------|
| | | | Gr1 | Gr2 | H | W | D |
|  | Write Board Panel - Double Sided - 54” High | EVPF2W5418 | 554 | 570 | 54 | 18 | 2 7/8 |
| | | EVPF2W5424 | 693 | 712 | 54 | 24 | 2 7/8 |
| | | EVPF2W5430 | 864 | 889 | 54 | 30 | 2 7/8 |
| | | EVPF2W5436 | 932 | 963 | 54 | 36 | 2 7/8 |
| | | EVPF2W5442 | 1059 | 1092 | 54 | 42 | 2 7/8 |
| | | EVPF2W5448 | 1239 | 1275 | 54 | 48 | 2 7/8 |
| | | EVPF2W5454 | 1375 | 1416 | 54 | 54 | 2 7/8 |
| | | EVPF2W5460 | 1515 | 1564 | 54 | 60 | 2 7/8 |
|  | Write Board Panel - Double Sided - 66” High | EVPF2W6618 | 687 | 713 | 66 | 18 | 2 7/8 |
| | | EVPF2W6624 | 857 | 886 | 66 | 24 | 2 7/8 |
| | | EVPF2W6630 | 1048 | 1084 | 66 | 30 | 2 7/8 |
| | | EVPF2W6636 | 1146 | 1190 | 66 | 36 | 2 7/8 |
| | | EVPF2W6642 | 1297 | 1346 | 66 | 42 | 2 7/8 |
| | | EVPF2W6648 | 1493 | 1546 | 66 | 48 | 2 7/8 |
| | | EVPF2W6654 | 1666 | 1727 | 66 | 54 | 2 7/8 |
| | | EVPF2W6660 | 1835 | 1903 | 66 | 60 | 2 7/8 |

EVPLF2W - WRITE BOARD LIGHT PANEL - DOUBLE SIDED

- Write Board Light Panel incorporates fabric modules with a single 24”H top position write board module, into a solid steel frame.
- Use erasable writeboard markers only.
- There is no base raceway in Light Panels to accommodate electrical.
- Light Panel Connectors must be used in conjunction with Light Panels.
- Opposite sides of each panel may have a different fabric within the same grade at no upcharge.
- If different grades of fabric are used on one panel, the entire panel must be priced at highest grade.
- An aluminum low profile top cap is included.
- Stackability: Evolve panels can be increased in height in 6”H, 12”H, 18”H or 24”H increments. See Extension Modules for part numbers.

| | DESCRIPTION | PRODUCT CODE | LIST PRICE | | DIMENSIONS/INCHES | | |
|---|---|--------------|------------|------|-------------------|----|-------|
| | | | Gr1 | Gr2 | H | W | D |
|  | Write Board Light Panel - Double Sided - 54” High | EVPLF2W5418 | 537 | 548 | 54 | 18 | 2 7/8 |
| | | EVPLF2W5424 | 673 | 687 | 54 | 18 | 2 7/8 |
| | | EVPLF2W5430 | 835 | 861 | 54 | 18 | 2 7/8 |
| | | EVPLF2W5436 | 908 | 932 | 54 | 18 | 2 7/8 |
| | | EVPLF2W5442 | 1026 | 1059 | 54 | 18 | 2 7/8 |
| | | EVPLF2W5448 | 1199 | 1234 | 54 | 18 | 2 7/8 |
| | | EVPLF2W5454 | 1334 | 1372 | 54 | 18 | 2 7/8 |
| | | EVPLF2W5460 | 1470 | 1514 | 54 | 18 | 2 7/8 |
|  | Write Board Light Panel - Double Sided - 66” High | EVPLF2W6618 | 668 | 687 | 66 | 18 | 2 7/8 |
| | | EVPLF2W6624 | 830 | 861 | 66 | 24 | 2 7/8 |
| | | EVPLF2W6630 | 1015 | 1052 | 66 | 30 | 2 7/8 |
| | | EVPLF2W6636 | 1113 | 1153 | 66 | 36 | 2 7/8 |
| | | EVPLF2W6642 | 1260 | 1307 | 66 | 42 | 2 7/8 |
| | | EVPLF2W6648 | 1448 | 1496 | 66 | 48 | 2 7/8 |
| | | EVPLF2W6654 | 1616 | 1671 | 66 | 54 | 2 7/8 |
| | | EVPLF2W6660 | 1843 | 1843 | 66 | 60 | 2 7/8 |

EVPH1S - LAMINATE PANEL - SINGLE SIDED

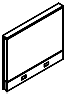
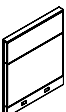
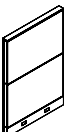
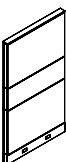

- Laminate Panel incorporates single sided laminate modules, into a solid steel frame.
- Opposite side is fabric covered.
- Laminate faces on all modules provide durable, washable surfaces on Single Sided of the panel.
- Available in high pressure laminate only.
- If wood grain is selected, grain runs horizontally.
- If different grades of fabric are used on one panel, the entire panel must be priced at highest grade.
- An aluminum low profile top cap is included.
- Stackability: Evolve panels can be increased in height in 6”H, 12”H, 18”H or 24”H increments. See Extension Modules for part numbers.

| | DESCRIPTION | PRODUCT CODE | LIST PRICE | | DIMENSIONS/INCHES | | |
|---|--|--------------|------------|------|-------------------|----|-------|
| | | | Gr1 | Gr2 | H | W | D |
|  | Laminate Panel - Single Sided - 30” High | EVPH1S3018 | 422 | 432 | 30 | 18 | 2 7/8 |
| | | EVPH1S3024 | 504 | 517 | 30 | 24 | 2 7/8 |
| | | EVPH1S3030 | 587 | 602 | 30 | 30 | 2 7/8 |
| | | EVPH1S3036 | 668 | 685 | 30 | 36 | 2 7/8 |
| | | EVPH1S3042 | 761 | 776 | 30 | 42 | 2 7/8 |
| | | EVPH1S3048 | 827 | 843 | 30 | 48 | 2 7/8 |
| | | EVPH1S3054 | 910 | 931 | 30 | 54 | 2 7/8 |
| | | EVPH1S3060 | 1000 | 1021 | 30 | 60 | 2 7/8 |
|  | Laminate Panel - Single Sided - 42” High | EVPH1S4218 | 502 | 515 | 42 | 18 | 2 7/8 |
| | | EVPH1S4224 | 597 | 614 | 42 | 24 | 2 7/8 |
| | | EVPH1S4230 | 699 | 718 | 42 | 30 | 2 7/8 |
| | | EVPH1S4236 | 800 | 826 | 42 | 36 | 2 7/8 |
| | | EVPH1S4242 | 908 | 933 | 42 | 42 | 2 7/8 |
| | | EVPH1S4248 | 986 | 1015 | 42 | 48 | 2 7/8 |
| | | EVPH1S4254 | 1094 | 1125 | 42 | 54 | 2 7/8 |
| | | EVPH1S4260 | 1199 | 1235 | 42 | 60 | 2 7/8 |
|  | Laminate Panel - Single Sided - 54” High | EVPH1S5418 | 588 | 602 | 54 | 18 | 2 7/8 |
| | | EVPH1S5424 | 708 | 733 | 54 | 24 | 2 7/8 |
| | | EVPH1S5430 | 830 | 857 | 54 | 30 | 2 7/8 |
| | | EVPH1S5436 | 951 | 978 | 54 | 36 | 2 7/8 |
| | | EVPH1S5442 | 1077 | 1112 | 54 | 42 | 2 7/8 |
| | | EVPH1S5448 | 1175 | 1213 | 54 | 48 | 2 7/8 |
| | | EVPH1S5454 | 1307 | 1346 | 54 | 54 | 2 7/8 |
| | | EVPH1S5460 | 1435 | 1482 | 54 | 60 | 2 7/8 |
|  | Laminate Panel - Single Sided - 66” High | EVPH1S6618 | 728 | 749 | 66 | 18 | 2 7/8 |
| | | EVPH1S6624 | 874 | 903 | 66 | 24 | 2 7/8 |
| | | EVPH1S6630 | 1021 | 1054 | 66 | 30 | 2 7/8 |
| | | EVPH1S6636 | 1179 | 1217 | 66 | 36 | 2 7/8 |
| | | EVPH1S6642 | 1340 | 1381 | 66 | 42 | 2 7/8 |
| | | EVPH1S6648 | 1457 | 1504 | 66 | 48 | 2 7/8 |
| | | EVPH1S6654 | 1624 | 1674 | 66 | 54 | 2 7/8 |
| | | EVPH1S6660 | 1786 | 1843 | 66 | 60 | 2 7/8 |





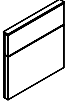
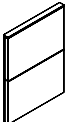

EVPLH1S - LAMINATE LIGHT PANEL - SINGLE SIDED

- Laminate Panel incorporates single sided laminate modules, into a solid steel frame.
- Opposite side is fabric covered.
- Laminate faces on all modules provide durable, washable surfaces on Single Sided of the panel.
- Available in high pressure laminate only.
- If wood grain is selected, grain runs horizontally.
- There is no base raceway in Light Panels to accommodate electrical.
- Light Panel Connectors must be used in conjunction with Light Panels.
- If different grades of fabric are used on one panel, the entire panel must be priced at highest grade.
- An aluminum low profile top cap is included.
- Stackability: Evolve panels can be increased in height in 6”H, 12”H, 18”H or 24”H increments. See Extension Modules for part numbers.

| | DESCRIPTION | PRODUCT CODE | LIST PRICE | | DIMENSIONS/INCHES | | |
|---|--|--------------|------------|------|-------------------|----|-------|
| | | | Gr1 | Gr2 | H | W | D |
|  | Laminate Light Panel - Single Sided - 30" High | EVPLH1S3018 | 411 | 418 | 30 | 18 | 2 7/8 |
| | | EVPLH1S3024 | 491 | 501 | 30 | 24 | 2 7/8 |
| | | EVPLH1S3030 | 570 | 578 | 30 | 30 | 2 7/8 |
| | | EVPLH1S3036 | 648 | 665 | 30 | 36 | 2 7/8 |
| | | EVPLH1S3042 | 735 | 748 | 30 | 42 | 2 7/8 |
| | | EVPLH1S3048 | 801 | 814 | 30 | 48 | 2 7/8 |
| | | EVPLH1S3054 | 882 | 905 | 30 | 54 | 2 7/8 |
| | | EVPLH1S3060 | 968 | 987 | 30 | 60 | 2 7/8 |
|  | Laminate Light Panel - Single Sided - 42" High | EVPLH1S4218 | 488 | 497 | 42 | 18 | 2 7/8 |
| | | EVPLH1S4224 | 577 | 594 | 42 | 24 | 2 7/8 |
| | | EVPLH1S4230 | 677 | 697 | 42 | 30 | 2 7/8 |
| | | EVPLH1S4236 | 775 | 799 | 42 | 36 | 2 7/8 |
| | | EVPLH1S4242 | 879 | 905 | 42 | 42 | 2 7/8 |
| | | EVPLH1S4248 | 959 | 982 | 42 | 48 | 2 7/8 |
| | | EVPLH1S4254 | 1062 | 1092 | 42 | 54 | 2 7/8 |
| | | EVPLH1S4260 | 1163 | 1195 | 42 | 60 | 2 7/8 |
|  | Laminate Light Panel - Single Sided - 54" High | EVPLH1S5418 | 571 | 578 | 54 | 18 | 2 7/8 |
| | | EVPLH1S5424 | 686 | 707 | 54 | 24 | 2 7/8 |
| | | EVPLH1S5430 | 807 | 828 | 54 | 30 | 2 7/8 |
| | | EVPLH1S5436 | 921 | 950 | 54 | 36 | 2 7/8 |
| | | EVPLH1S5442 | 1044 | 1074 | 54 | 42 | 2 7/8 |
| | | EVPLH1S5448 | 1139 | 1174 | 54 | 48 | 2 7/8 |
| | | EVPLH1S5454 | 1267 | 1306 | 54 | 54 | 2 7/8 |
| | | EVPLH1S5460 | 1392 | 1434 | 54 | 60 | 2 7/8 |
|  | Laminate Light Panel - Single Sided - 66" High | EVPLH1S6618 | 706 | 725 | 66 | 18 | 2 7/8 |
| | | EVPLH1S6624 | 849 | 872 | 66 | 24 | 2 7/8 |
| | | EVPLH1S6630 | 989 | 1020 | 66 | 30 | 2 7/8 |
| | | EVPLH1S6636 | 1142 | 1176 | 66 | 36 | 2 7/8 |
| | | EVPLH1S6642 | 1297 | 1336 | 66 | 42 | 2 7/8 |
| | | EVPLH1S6648 | 1416 | 1456 | 66 | 48 | 2 7/8 |
| | | EVPLH1S6654 | 1573 | 1624 | 66 | 54 | 2 7/8 |
| | | EVPLH1S6660 | 1732 | 1786 | 66 | 60 | 2 7/8 |

EVPH2S - LAMINATE PANEL - DOUBLE SIDED





- Laminate Panel incorporates double sided laminate modules, into a solid steel frame.
- Laminate faces on all modules provide durable, washable surfaces on Single Sided of the panel.
- Available in high pressure laminate only.
- If wood grain is selected, grain runs horizontally.
- If different grades of fabric are used on one panel, the entire panel must be priced at highest grade.
- An aluminum low profile top cap is included.
- Stackability: Evolve panels can be increased in height in 6”H, 12”H, 18”H or 24”H increments. See Extension Modules for part numbers.

| | DESCRIPTION | PRODUCT CODE | LIST PRICE | DIMENSIONS/INCHES | | |
|---|--|--------------|------------|-------------------|-------|-------|
| | | | | H | W | D |
|  | Laminate Panel - Double Sided - 30" High | EVPH2S3018 | 575 | 30 | 18 | 2 7/8 |
| | | EVPH2S3024 | 575 | 30 | 24 | 2 7/8 |
| | | EVPH2S3030 | 678 | 30 | 30 | 2 7/8 |
| | | EVPH2S3036 | 775 | 30 | 36 | 2 7/8 |
| | | EVPH2S3042 | 882 | 30 | 42 | 2 7/8 |
| | | EVPH2S3048 | 984 | 30 | 48 | 2 7/8 |
| | | EVPH2S3054 | 1092 | 30 | 54 | 2 7/8 |
| | EVPH2S3060 | 1179 | 30 | 60 | 2 7/8 | |
|  | Laminate Panel - Double Sided - 42" High | EVPH2S4218 | 558 | 42 | 18 | 2 7/8 |
| | | EVPH2S4224 | 678 | 42 | 24 | 2 7/8 |
| | | EVPH2S4230 | 799 | 42 | 30 | 2 7/8 |
| | | EVPH2S4236 | 929 | 42 | 36 | 2 7/8 |
| | | EVPH2S4242 | 1059 | 42 | 42 | 2 7/8 |
| | | EVPH2S4248 | 1185 | 42 | 48 | 2 7/8 |
| | | EVPH2S4254 | 1304 | 42 | 54 | 2 7/8 |
| | EVPH2S4260 | 1417 | 42 | 60 | 2 7/8 | |
|  | Laminate Panel - Double Sided - 54" High | EVPH2S5418 | 655 | 54 | 18 | 2 7/8 |
| | | EVPH2S5424 | 801 | 54 | 24 | 2 7/8 |
| | | EVPH2S5430 | 950 | 54 | 30 | 2 7/8 |
| | | EVPH2S5436 | 1103 | 54 | 36 | 2 7/8 |
| | | EVPH2S5442 | 1259 | 54 | 42 | 2 7/8 |
| | | EVPH2S5448 | 1416 | 54 | 48 | 2 7/8 |
| | | EVPH2S5454 | 1560 | 54 | 54 | 2 7/8 |
| | EVPH2S5460 | 1697 | 54 | 60 | 2 7/8 | |
|  | Laminate Panel - Double Sided - 66" High | EVPH2S6618 | 827 | 66 | 18 | 2 7/8 |
| | | EVPH2S6624 | 1014 | 66 | 24 | 2 7/8 |
| | | EVPH2S6630 | 1199 | 66 | 30 | 2 7/8 |
| | | EVPH2S6636 | 1392 | 66 | 36 | 2 7/8 |
| | | EVPH2S6642 | 1593 | 66 | 42 | 2 7/8 |
| | | EVPH2S6648 | 1786 | 66 | 48 | 2 7/8 |
| | | EVPH2S6654 | 1971 | 66 | 54 | 2 7/8 |
| | EVPH2S6660 | 2153 | 66 | 60 | 2 7/8 | |





EVPLH2S - LAMINATE LIGHT PANEL - DOUBLE SIDED

- Laminate Panel incorporates double sided laminate modules, into a solid steel frame.
- Laminate faces on all modules provide durable, washable surfaces on Single Sided of the panel.
- Available in high pressure laminate only
- If wood grain is selected, grain runs horizontally.
- There is no base raceway in Light Panels to accommodate electrical.
- Light Panel Connectors must be used in conjunction with Light Panels.
- If different grades of fabric are used on one panel, the entire panel must be priced at highest grade.
- An aluminum low profile top cap is included.
- Stackability: Evolve panels can be increased in height in 6”H, 12”H, 18”H or 24”H increments. See Extension Modules for part numbers.

| | DESCRIPTION | PRODUCT CODE | LIST PRICE | DIMENSIONS/INCHES | | |
|---|--|--------------|------------|-------------------|----|-------|
| | | | | H | W | D |
|  | Laminate Light Panel - Double Sided - 30" High | EVPLH2S3018 | 557 | 30 | 18 | 2 7/8 |
| | | EVPLH2S3024 | 557 | 30 | 24 | 2 7/8 |
| | | EVPLH2S3030 | 657 | 30 | 30 | 2 7/8 |
| | | EVPLH2S3036 | 751 | 30 | 36 | 2 7/8 |
| | | EVPLH2S3042 | 858 | 30 | 42 | 2 7/8 |
| | | EVPLH2S3048 | 957 | 30 | 48 | 2 7/8 |
| | | EVPLH2S3054 | 1060 | 30 | 54 | 2 7/8 |
| | | EVPLH2S3060 | 1142 | 30 | 60 | 2 7/8 |
|  | Laminate Light Panel - Double Sided - 42" High | EVPLH2S4218 | 543 | 42 | 18 | 2 7/8 |
| | | EVPLH2S4224 | 657 | 42 | 24 | 2 7/8 |
| | | EVPLH2S4230 | 774 | 42 | 30 | 2 7/8 |
| | | EVPLH2S4236 | 902 | 42 | 36 | 2 7/8 |
| | | EVPLH2S4242 | 1026 | 42 | 42 | 2 7/8 |
| | | EVPLH2S4248 | 1152 | 42 | 48 | 2 7/8 |
| | | EVPLH2S4254 | 1263 | 42 | 54 | 2 7/8 |
| | | EVPLH2S4260 | 1375 | 42 | 60 | 2 7/8 |
|  | Laminate Light Panel - Double Sided - 54" High | EVPLH2S5418 | 635 | 54 | 18 | 2 7/8 |
| | | EVPLH2S5424 | 776 | 54 | 24 | 2 7/8 |
| | | EVPLH2S5430 | 920 | 54 | 30 | 2 7/8 |
| | | EVPLH2S5436 | 1069 | 54 | 36 | 2 7/8 |
| | | EVPLH2S5442 | 1220 | 54 | 42 | 2 7/8 |
| | | EVPLH2S5448 | 1374 | 54 | 48 | 2 7/8 |
| | | EVPLH2S5454 | 1513 | 54 | 54 | 2 7/8 |
| | | EVPLH2S5460 | 1643 | 54 | 60 | 2 7/8 |
|  | Laminate Light Panel - Double Sided - 66" High | EVPLH2S6618 | 706 | 66 | 18 | 2 7/8 |
| | | EVPLH2S6624 | 982 | 66 | 24 | 2 7/8 |
| | | EVPLH2S6630 | 1163 | 66 | 30 | 2 7/8 |
| | | EVPLH2S6636 | 1349 | 66 | 36 | 2 7/8 |
| | | EVPLH2S6642 | 1544 | 66 | 42 | 2 7/8 |
| | | EVPLH2S6648 | 1732 | 66 | 48 | 2 7/8 |
| | | EVPLH2S6654 | 1912 | 66 | 54 | 2 7/8 |
| | | EVPLH2S6660 | 2088 | 66 | 60 | 2 7/8 |

EVPPAF - AIRFLOW PANEL

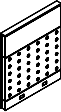
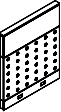
- Airflow Panel incorporates bottom 24”H airflow module with individual fabric modules, within a steel frame.
- The 24”H Metal airflow module is positioned in the base section to provide air circulation.
- Opposite sides of each panel may have a different fabric within the same grade at no upcharge.
- If different grades of fabric are used on one panel, the entire panel must be priced at highest grade.
- An aluminum low profile top cap is included.
- Stackability: Evolve panels can be increased in height in 6”H, 12”H, 18”H or 24”H increments. See Extension Modules for part numbers.

| | DESCRIPTION | PRODUCT CODE | LIST PRICE | | DIMENSIONS/INCHES | | |
|---|--------------------------|--------------|------------|------|-------------------|----|-------|
| | | | Gr1 | Gr2 | H | W | D |
|  | Airflow Panel - 30” High | EVPPAF3024 | 483 | | 30 | 24 | 2 7/8 |
| | | EVPPAF3030 | 574 | | 30 | 30 | 2 7/8 |
| | | EVPPAF3036 | 635 | | 30 | 36 | 2 7/8 |
| | | EVPPAF3042 | 706 | | 30 | 42 | 2 7/8 |
| | | EVPPAF3048 | 796 | | 30 | 48 | 2 7/8 |
| | | EVPPAF3054 | 912 | | 30 | 54 | 2 7/8 |
| | | EVPPAF3060 | 1029 | | 30 | 60 | 2 7/8 |
|  | Airflow Panel - 42” High | EVPPAF4224 | 615 | 625 | 42 | 24 | 2 7/8 |
| | | EVPPAF4230 | 728 | 743 | 42 | 30 | 2 7/8 |
| | | EVPPAF4236 | 810 | 827 | 42 | 36 | 2 7/8 |
| | | EVPPAF4242 | 900 | 917 | 42 | 42 | 2 7/8 |
| | | EVPPAF4248 | 1017 | 1035 | 42 | 48 | 2 7/8 |
| | | EVPPAF4254 | 1158 | 1179 | 42 | 54 | 2 7/8 |
| | | EVPPAF4260 | 1175 | 1199 | 42 | 60 | 2 7/8 |
|  | Airflow Panel - 54” High | EVPPAF5424 | 690 | 714 | 54 | 24 | 2 7/8 |
| | | EVPPAF5430 | 795 | 820 | 54 | 30 | 2 7/8 |
| | | EVPPAF5436 | 888 | 918 | 54 | 36 | 2 7/8 |
| | | EVPPAF5442 | 989 | 1024 | 54 | 42 | 2 7/8 |
| | | EVPPAF5448 | 1113 | 1152 | 54 | 48 | 2 7/8 |
| | | EVPPAF5454 | 1295 | 1339 | 54 | 54 | 2 7/8 |
| | | EVPPAF5460 | 1413 | 1459 | 54 | 60 | 2 7/8 |
|  | Airflow Panel - 66” High | EVPPAF6624 | 806 | 835 | 66 | 24 | 2 7/8 |
| | | EVPPAF6630 | 950 | 985 | 66 | 30 | 2 7/8 |
| | | EVPPAF6636 | 1063 | 1107 | 66 | 36 | 2 7/8 |
| | | EVPPAF6642 | 1185 | 1233 | 66 | 42 | 2 7/8 |
| | | EVPPAF6648 | 1335 | 1389 | 66 | 48 | 2 7/8 |
| | | EVPPAF6654 | 1509 | 1570 | 66 | 54 | 2 7/8 |
| | | EVPPAF6660 | 1679 | 1747 | 66 | 60 | 2 7/8 |



EVPLFAF - AIRFLOW LIGHT PANEL

- Airflow Light Panel incorporates bottom 24”H airflow module with individual fabric modules, within a steel frame.
- The 24”H Metal airflow module is positioned in the base section to provide air circulation.
- There is no base raceway in Light Panels to accommodate electrical.
- Light Panel Connectors must be used in conjunction with Light Panels.
- Opposite sides of each panel may have a different fabric within the same grade at no upcharge.
- If different grades of fabric are used on one panel, the entire panel must be priced at highest grade.
- An aluminum low profile top cap is included.
- Stackability: Evolve panels can be increased in height in 6”H, 12”H, 18”H or 24”H increments. See Extension Module listings for part numbers

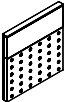
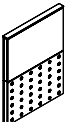
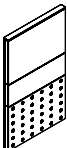
| | DESCRIPTION | PRODUCT CODE | LIST PRICE | | DIMENSIONS/INCHES | | |
|---|--------------------------------|--------------|------------|------|-------------------|----|-------|
| | | | Gr1 | Gr2 | H | W | D |
|  | Airflow Light Panel - 30” High | EVPLFAF3024 | 470 | | 30 | 18 | 2 7/8 |
| | | EVPLFAF3030 | 556 | | 30 | 30 | 2 7/8 |
| | | EVPLFAF3036 | 616 | | 30 | 36 | 2 7/8 |
| | | EVPLFAF3042 | 684 | | 30 | 42 | 2 7/8 |
| | | EVPLFAF3048 | 770 | | 30 | 48 | 2 7/8 |
| | | EVPLFAF3054 | 886 | | 30 | 54 | 2 7/8 |
| | | EVPLFAF3060 | 1001 | | 30 | 60 | 2 7/8 |
|  | Airflow Light Panel - 42” High | EVPLFAF4224 | 598 | 605 | 42 | 18 | 2 7/8 |
| | | EVPLFAF4230 | 706 | 718 | 42 | 30 | 2 7/8 |
| | | EVPLFAF4236 | 785 | 801 | 42 | 36 | 2 7/8 |
| | | EVPLFAF4242 | 871 | 887 | 42 | 42 | 2 7/8 |
| | | EVPLFAF4248 | 984 | 1004 | 42 | 48 | 2 7/8 |
| | | EVPLFAF4254 | 1121 | 1141 | 42 | 54 | 2 7/8 |
| | | EVPLFAF4260 | 1139 | 1161 | 42 | 60 | 2 7/8 |
|  | Airflow Light Panel - 54” High | EVPLFAF5424 | 671 | 687 | 54 | 18 | 2 7/8 |
| | | EVPLFAF5430 | 769 | 795 | 54 | 30 | 2 7/8 |
| | | EVPLFAF5436 | 864 | 888 | 54 | 36 | 2 7/8 |
| | | EVPLFAF5442 | 961 | 992 | 54 | 42 | 2 7/8 |
| | | EVPLFAF5448 | 1078 | 1115 | 54 | 48 | 2 7/8 |
| | | EVPLFAF5454 | 1257 | 1293 | 54 | 54 | 2 7/8 |
| | | EVPLFAF5460 | 1371 | 1413 | 54 | 60 | 2 7/8 |
|  | Airflow Light Panel - 66” High | EVPLFAF6624 | 779 | 808 | 66 | 18 | 2 7/8 |
| | | EVPLFAF6630 | 920 | 956 | 66 | 30 | 2 7/8 |
| | | EVPLFAF6636 | 1032 | 1072 | 66 | 36 | 2 7/8 |
| | | EVPLFAF6642 | 1152 | 1194 | 66 | 42 | 2 7/8 |
| | | EVPLFAF6648 | 1294 | 1346 | 66 | 48 | 2 7/8 |
| | | EVPLFAF6654 | 1465 | 1518 | 66 | 54 | 2 7/8 |
| | | EVPLFAF6660 | 1630 | 1691 | 30 | 60 | 2 7/8 |

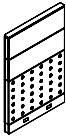
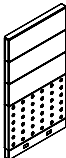

EVPPPAF - AIRFLOW PREMIUM PANEL

- Airflow Premium Panel incorporates bottom 24”H airflow module with individual fabric modules, within a steel frame.
- The 24”H Metal airflow module is positioned in the base section to provide air circulation.
- Premium panels incorporate 12”H acoustic modules above 30”H base section.
- Opposite sides of each panel may have a different fabric within the same grade at no upcharge.
- If different grades of fabric are used on one panel, the entire panel must be priced at highest grade.
- An aluminum low profile top cap is included.
- Stackability: Evolve panels can be increased in height in 6”H, 12”H, 18”H or 24”H increments. See Extension Modules for part numbers.

| | DESCRIPTION | PRODUCT CODE | LIST PRICE | | DIMENSIONS/INCHES | | |
|---|----------------------------------|--------------|------------|------|-------------------|----|-------|
| | | | Gr1 | Gr2 | H | W | D |
|  | Airflow Premium Panel - 54” High | EVPPPAF5424 | 767 | 785 | 54 | 24 | 2 7/8 |
| | | EVPPPAF5430 | 878 | 905 | 54 | 30 | 2 7/8 |
| | | EVPPPAF5436 | 982 | 1011 | 54 | 36 | 2 7/8 |
| | | EVPPPAF5442 | 1091 | 1124 | 54 | 42 | 2 7/8 |
| | | EVPPPAF5448 | 1235 | 1273 | 54 | 48 | 2 7/8 |
| | | EVPPPAF5454 | 1396 | 1439 | 54 | 54 | 2 7/8 |
|  | Airflow Premium Panel - 66” High | EVPPPAF6624 | 879 | 910 | 66 | 24 | 2 7/8 |
| | | EVPPPAF6630 | 1032 | 1070 | 66 | 30 | 2 7/8 |
| | | EVPPPAF6636 | 1155 | 1198 | 66 | 36 | 2 7/8 |
| | | EVPPPAF6642 | 1282 | 1331 | 66 | 42 | 2 7/8 |
| | | EVPPPAF6648 | 1456 | 1513 | 66 | 48 | 2 7/8 |
| | | EVPPPAF6654 | 1639 | 1701 | 66 | 54 | 2 7/8 |
| EVPPPAF6660 | 1829 | 1895 | 66 | 60 | 2 7/8 | | |

EVPLPPAF - AIRFLOW PREMIUM LIGHT PANEL

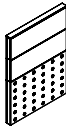



- Airflow Premium Light Panel incorporates bottom 24”H airflow module with individual 12”H fabric modules, within a steel frame.
- The 24”H Metal airflow module is positioned in the base section to provide air circulation.
- Premium panels incorporate 12”H acoustic modules above 30”H base section.
- There is no base raceway in Light Panels to accommodate electrical.
- Light Panel Connectors must be used in conjunction with Light Panels.
- Opposite sides of each panel may have a different fabric within the same grade at no upcharge.
- If different grades of fabric are used on one panel, the entire panel must be priced at highest grade.
- An aluminum low profile top cap is included.
- Stackability: Evolve panels can be increased in height in 6”H, 12”H, 18”H or 24”H increments. See Extension Modules for part numbers.

| | DESCRIPTION | PRODUCT CODE | LIST PRICE | | DIMENSIONS/INCHES | | |
|---|--|--------------|------------|------|-------------------|----|-------|
| | | | Gr1 | Gr2 | H | W | D |
|  | Airflow Premium Light Panel - 54” High | EVPLPPAF5424 | 744 | 764 | 54 | 18 | 2 7/8 |
| | | EVPLPPAF5430 | 854 | 874 | 54 | 30 | 2 7/8 |
| | | EVPLPPAF5436 | 954 | 978 | 54 | 36 | 2 7/8 |
| | | EVPLPPAF5442 | 1059 | 1088 | 54 | 42 | 2 7/8 |
| | | EVPLPPAF5448 | 1196 | 1231 | 54 | 48 | 2 7/8 |
| | | EVPLPPAF5454 | 1356 | 1391 | 54 | 54 | 2 7/8 |
|  | Airflow Premium Light Panel - 66” High | EVPLPPAF6624 | 855 | 880 | 66 | 18 | 2 7/8 |
| | | EVPLPPAF6630 | 1003 | 1034 | 66 | 30 | 2 7/8 |
| | | EVPLPPAF6636 | 1120 | 1161 | 66 | 36 | 2 7/8 |
| | | EVPLPPAF6642 | 1243 | 1287 | 66 | 42 | 2 7/8 |
| | | EVPLPPAF6648 | 1414 | 1466 | 66 | 48 | 2 7/8 |
| | | EVPLPPAF6654 | 1591 | 1643 | 66 | 54 | 2 7/8 |
| EVPLPPAF6660 | 1773 | 1834 | 66 | 60 | 2 7/8 | | |



EVPM1S - METAL SKIN PANEL - SINGLE SIDED

- Metal Skin Panel incorporates single sided metal skin modules, into a solid steel frame.
- Opposite side is fabric covered.
- Metal faces on all modules provide durable, washable and magnetic surfaces on Single Sided of the panel.
- If different grades of fabric are used on one panel, the entire panel must be priced at highest grade.
- An aluminum low profile top cap is included.
- Stackability: Evolve panels can be increased in height in 6”H, 12”H, 18”H or 24”H increments. See Extension Modules for part numbers.

| | DESCRIPTION | PRODUCT CODE | LIST PRICE | | DIMENSIONS/INCHES | | |
|---|---|--------------|------------|------|-------------------|----|-------|
| | | | Gr1 | Gr2 | H | W | D |
|  | Metal Skin Panel - Single Sided 30" High | EVPM1S3018 | 547 | 557 | 30 | 18 | 2 7/8 |
| | | EVPM1S3024 | 655 | 669 | 30 | 24 | 2 7/8 |
| | | EVPM1S3030 | 763 | 776 | 30 | 30 | 2 7/8 |
| | | EVPM1S3036 | 867 | 883 | 30 | 36 | 2 7/8 |
| | | EVPM1S3042 | 983 | 1002 | 30 | 42 | 2 7/8 |
| | | EVPM1S3048 | 1071 | 1090 | 30 | 48 | 2 7/8 |
| | | EVPM1S3054 | 1183 | 1202 | 30 | 54 | 2 7/8 |
| | | EVPM1S3060 | 1295 | 1319 | 30 | 60 | 2 7/8 |
|  | Metal Skin Panel - Single Sided 42" High | EVPM1S4218 | 649 | 662 | 42 | 18 | 2 7/8 |
| | | EVPM1S4224 | 773 | 788 | 42 | 24 | 2 7/8 |
| | | EVPM1S4230 | 908 | 926 | 42 | 30 | 2 7/8 |
| | | EVPM1S4236 | 1038 | 1065 | 42 | 36 | 2 7/8 |
| | | EVPM1S4242 | 1179 | 1205 | 42 | 42 | 2 7/8 |
| | | EVPM1S4248 | 1281 | 1310 | 42 | 48 | 2 7/8 |
| | | EVPM1S4254 | 1423 | 1452 | 42 | 54 | 2 7/8 |
| | | EVPM1S4260 | 1561 | 1594 | 42 | 60 | 2 7/8 |
|  | Metal Skin Panel - Single Sided 54" High | EVPM1S5418 | 765 | 780 | 54 | 18 | 2 7/8 |
| | | EVPM1S5424 | 920 | 939 | 54 | 24 | 2 7/8 |
| | | EVPM1S5430 | 1077 | 1103 | 54 | 30 | 2 7/8 |
| | | EVPM1S5436 | 1231 | 1261 | 54 | 36 | 2 7/8 |
| | | EVPM1S5442 | 1397 | 1432 | 54 | 42 | 2 7/8 |
| | | EVPM1S5448 | 1526 | 1565 | 54 | 48 | 2 7/8 |
| | | EVPM1S5454 | 1697 | 1741 | 54 | 54 | 2 7/8 |
| | | EVPM1S5460 | 1865 | 1909 | 54 | 60 | 2 7/8 |
|  | Metal Skin Panel - Single Sided 66" High | EVPM1S6618 | 942 | 966 | 66 | 18 | 2 7/8 |
| | | EVPM1S6624 | 1136 | 1163 | 66 | 24 | 2 7/8 |
| | | EVPM1S6630 | 1327 | 1358 | 66 | 30 | 2 7/8 |
| | | EVPM1S6636 | 1531 | 1569 | 66 | 36 | 2 7/8 |
| | | EVPM1S6642 | 1740 | 1781 | 66 | 42 | 2 7/8 |
| | | EVPM1S6648 | 1894 | 1941 | 66 | 48 | 2 7/8 |
| | | EVPM1S6654 | 2106 | 2157 | 66 | 54 | 2 7/8 |
| | | EVPM1S6660 | 2320 | 2377 | 66 | 60 | 2 7/8 |





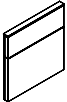
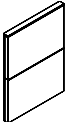
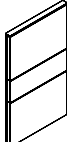

EVPLM1S - METAL SKIN LIGHT PANEL - SINGLE SIDED

- Metal Skin Light Panel incorporates single sided metal skin modules, into a solid steel frame.
- Opposite side is fabric covered.
- Metal faces on all modules provide durable, washable and magnetic surfaces on Single Sided of the panel.
- There is no base raceway in Light Panels to accommodate electrical.
- Light Panel Connectors must be used in conjunction with Light Panels.
- If different grades of fabric are used on one panel, the entire panel must be priced at highest grade.
- An aluminum low profile top cap is included.
- Stackability: Evolve panels can be increased in height in 6”H, 12”H, 18”H or 24”H increments. See Extension Modules for part numbers.

| | DESCRIPTION | PRODUCT CODE | LIST PRICE | | DIMENSIONS/INCHES | | |
|---|--|--------------|------------|------|-------------------|----|-------|
| | | | Gr1 | Gr2 | H | W | D |
|  | Metal Skin Light Panel - Single Sided - 30” High | EVPLM1S3018 | 533 | 541 | 30 | 18 | 2 7/8 |
| | | EVPLM1S3024 | 635 | 646 | 30 | 24 | 2 7/8 |
| | | EVPLM1S3030 | 736 | 747 | 30 | 30 | 2 7/8 |
| | | EVPLM1S3036 | 840 | 857 | 30 | 36 | 2 7/8 |
| | | EVPLM1S3042 | 956 | 970 | 30 | 42 | 2 7/8 |
| | | EVPLM1S3048 | 1038 | 1055 | 30 | 48 | 2 7/8 |
| | | EVPLM1S3054 | 1150 | 1164 | 30 | 54 | 2 7/8 |
| | | EVPLM1S3060 | 1257 | 1278 | 30 | 60 | 2 7/8 |
|  | Metal Skin Light Panel - Single Sided - 42” High | EVPLM1S4218 | 632 | 642 | 42 | 18 | 2 7/8 |
| | | EVPLM1S4224 | 748 | 765 | 42 | 24 | 2 7/8 |
| | | EVPLM1S4230 | 879 | 899 | 42 | 30 | 2 7/8 |
| | | EVPLM1S4236 | 1008 | 1028 | 42 | 36 | 2 7/8 |
| | | EVPLM1S4242 | 1142 | 1164 | 42 | 42 | 2 7/8 |
| | | EVPLM1S4248 | 1242 | 1270 | 42 | 48 | 2 7/8 |
| | | EVPLM1S4254 | 1378 | 1406 | 42 | 54 | 2 7/8 |
| | | EVPLM1S4260 | 1514 | 1544 | 42 | 60 | 2 7/8 |
|  | Metal Skin Light Panel - Single Sided - 54” High | EVPLM1S5418 | 739 | 753 | 54 | 18 | 2 7/8 |
| | | EVPLM1S5424 | 890 | 910 | 54 | 24 | 2 7/8 |
| | | EVPLM1S5430 | 1044 | 1066 | 54 | 30 | 2 7/8 |
| | | EVPLM1S5436 | 1194 | 1221 | 54 | 36 | 2 7/8 |
| | | EVPLM1S5442 | 1357 | 1388 | 54 | 42 | 2 7/8 |
| | | EVPLM1S5448 | 1481 | 1515 | 54 | 48 | 2 7/8 |
| | | EVPLM1S5454 | 1643 | 1687 | 54 | 54 | 2 7/8 |
| | | EVPLM1S5460 | 1808 | 1851 | 54 | 60 | 2 7/8 |
|  | Metal Skin Light Panel - Single Sided - 66” High | EVPLM1S6618 | 916 | 932 | 66 | 18 | 2 7/8 |
| | | EVPLM1S6624 | 1103 | 1124 | 66 | 24 | 2 7/8 |
| | | EVPLM1S6630 | 1286 | 1316 | 66 | 30 | 2 7/8 |
| | | EVPLM1S6636 | 1484 | 1520 | 66 | 36 | 2 7/8 |
| | | EVPLM1S6642 | 1688 | 1726 | 66 | 42 | 2 7/8 |
| | | EVPLM1S6648 | 1835 | 1879 | 66 | 48 | 2 7/8 |
| | | EVPLM1S6654 | 2044 | 2090 | 66 | 54 | 2 7/8 |
| | | EVPLM1S6660 | 2250 | 2305 | 66 | 60 | 2 7/8 |

EVPM2S - METAL SKIN PANEL - DOUBLE SIDED

- Metal Skin Panel incorporates double sided metal skin modules, into a solid steel frame.
- Metal faces on all modules provide durable, washable and magnetic surfaces on Single Sided of the panel.
- If different grades of fabric are used on one panel, the entire panel must be priced at highest grade.
- An aluminum low profile top cap is included.
- Stackability: Evolve panels can be increased in height in 6”H, 12”H, 18”H or 24”H increments. See Extension Modules for part numbers.

| | DESCRIPTION | PRODUCT CODE | LIST PRICE | DIMENSIONS/INCHES | | |
|---|--|--------------|------------|-------------------|----|-------|
| | | | | H | W | D |
|  | Metal Skin Panel - Double Sided - 30” High | EVPM2S3018 | 806 | 30 | 18 | 2 7/8 |
| | | EVPM2S3024 | 806 | 30 | 24 | 2 7/8 |
| | | EVPM2S3030 | 948 | 30 | 30 | 2 7/8 |
| | | EVPM2S3036 | 1085 | 30 | 36 | 2 7/8 |
| | | EVPM2S3042 | 1085 | 30 | 42 | 2 7/8 |
| | | EVPM2S3048 | 1231 | 30 | 48 | 2 7/8 |
| | | EVPM2S3054 | 1377 | 30 | 54 | 2 7/8 |
| | | EVPM2S3060 | 1645 | 30 | 60 | 2 7/8 |
|  | Metal Skin Panel - Double Sided - 42” High | EVPM2S4218 | 779 | 42 | 18 | 2 7/8 |
| | | EVPM2S4224 | 948 | 42 | 24 | 2 7/8 |
| | | EVPM2S4230 | 1116 | 42 | 30 | 2 7/8 |
| | | EVPM2S4236 | 1297 | 42 | 36 | 2 7/8 |
| | | EVPM2S4242 | 1479 | 42 | 42 | 2 7/8 |
| | | EVPM2S4248 | 1659 | 42 | 48 | 2 7/8 |
| | | EVPM2S4254 | 1822 | 42 | 54 | 2 7/8 |
| | | EVPM2S4260 | 1983 | 42 | 60 | 2 7/8 |
|  | Metal Skin Panel - Double Sided - 54” High | EVPM2S5418 | 916 | 54 | 18 | 2 7/8 |
| | | EVPM2S5424 | 1120 | 54 | 24 | 2 7/8 |
| | | EVPM2S5430 | 1326 | 54 | 30 | 2 7/8 |
| | | EVPM2S5436 | 1540 | 54 | 36 | 2 7/8 |
| | | EVPM2S5442 | 1762 | 54 | 42 | 2 7/8 |
| | | EVPM2S5448 | 1980 | 54 | 48 | 2 7/8 |
| | | EVPM2S5454 | 2178 | 54 | 54 | 2 7/8 |
| | | EVPM2S5460 | 2375 | 54 | 60 | 2 7/8 |
|  | Metal Skin Panel - Double Sided - 66” High | EVPM2S6618 | 1153 | 66 | 18 | 2 7/8 |
| | | EVPM2S6624 | 1417 | 66 | 24 | 2 7/8 |
| | | EVPM2S6630 | 1678 | 66 | 30 | 2 7/8 |
| | | EVPM2S6636 | 1949 | 66 | 36 | 2 7/8 |
| | | EVPM2S6642 | 2227 | 66 | 42 | 2 7/8 |
| | | EVPM2S6648 | 2499 | 66 | 48 | 2 7/8 |
| | | EVPM2S6654 | 2756 | 66 | 54 | 2 7/8 |
| | | EVPM2S6660 | 3016 | 66 | 60 | 2 7/8 |



EVPLM2S - METAL SKIN LIGHT PANEL - DOUBLE SIDED

- Metal Skin Light Panel incorporates double sided metal skin modules, into a solid steel frame.
- Metal faces on all modules provide durable, washable and magnetic surfaces on Single Sided of the panel.
- There is no base raceway in Light Panels to accommodate electrical.
- Light Panel Connectors must be used in conjunction with Light Panels.
- If different grades of fabric are used on one panel, the entire panel must be priced at highest grade.
- An aluminum low profile top cap is included.
- Stackability: Evolve panels can be increased in height in 6”H, 12”H, 18”H or 24”H increments. See Extension Modules for part numbers.

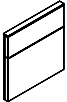
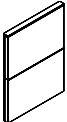
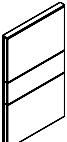
| | DESCRIPTION | PRODUCT CODE | LIST PRICE | DIMENSIONS/INCHES | | |
|---|--|--------------|------------|-------------------|----|-------|
| | | | | H | W | D |
|  | Metal Skin Light Panel - Double Sided - 30" High | EVPLM2S3018 | 779 | 30 | 18 | 2 7/8 |
| | | EVPLM2S3024 | 779 | 30 | 24 | 2 7/8 |
| | | EVPLM2S3030 | 919 | 30 | 30 | 2 7/8 |
| | | EVPLM2S3036 | 1053 | 30 | 36 | 2 7/8 |
| | | EVPLM2S3042 | 1053 | 30 | 42 | 2 7/8 |
| | | EVPLM2S3048 | 1194 | 30 | 48 | 2 7/8 |
| | | EVPLM2S3054 | 1335 | 30 | 54 | 2 7/8 |
| | | EVPLM2S3060 | 1598 | 30 | 60 | 2 7/8 |
|  | Metal Skin Light Panel - Double Sided - 42" High | EVPLM2S4218 | 757 | 42 | 18 | 2 7/8 |
| | | EVPLM2S4224 | 919 | 42 | 24 | 2 7/8 |
| | | EVPLM2S4230 | 1081 | 42 | 30 | 2 7/8 |
| | | EVPLM2S4236 | 1260 | 42 | 36 | 2 7/8 |
| | | EVPLM2S4242 | 1433 | 42 | 42 | 2 7/8 |
| | | EVPLM2S4248 | 1608 | 42 | 48 | 2 7/8 |
| | | EVPLM2S4254 | 1768 | 42 | 54 | 2 7/8 |
| | | EVPLM2S4260 | 1923 | 42 | 60 | 2 7/8 |
|  | Metal Skin Light Panel - Double Sided - 54" High | EVPLM2S5418 | 887 | 54 | 18 | 2 7/8 |
| | | EVPLM2S5424 | 1087 | 54 | 24 | 2 7/8 |
| | | EVPLM2S5430 | 1285 | 54 | 30 | 2 7/8 |
| | | EVPLM2S5436 | 1494 | 54 | 36 | 2 7/8 |
| | | EVPLM2S5442 | 1709 | 54 | 42 | 2 7/8 |
| | | EVPLM2S5448 | 1920 | 54 | 48 | 2 7/8 |
| | | EVPLM2S5454 | 2111 | 54 | 54 | 2 7/8 |
| | | EVPLM2S5460 | 2304 | 54 | 60 | 2 7/8 |
|  | Metal Skin Light Panel - Double Sided - 66" High | EVPLM2S6618 | 1118 | 66 | 18 | 2 7/8 |
| | | EVPLM2S6624 | 1375 | 66 | 24 | 2 7/8 |
| | | EVPLM2S6630 | 1628 | 66 | 30 | 2 7/8 |
| | | EVPLM2S6636 | 1891 | 66 | 36 | 2 7/8 |
| | | EVPLM2S6642 | 2158 | 66 | 42 | 2 7/8 |
| | | EVPLM2S6648 | 2425 | 66 | 48 | 2 7/8 |
| | | EVPLM2S6654 | 2671 | 66 | 54 | 2 7/8 |
| | | EVPLM2S6660 | 2953 | 66 | 60 | 2 7/8 |

EVPFOL - OPEN BOTTOM PANEL

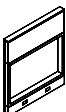
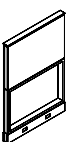
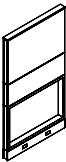

- Open Bottom Panel incorporates bottom 24”H open module with individual fabric modules, within a steel frame.
- The 24”H open bottom module in the base section is to provide air circulation and access to electrical or data.
- Opposite sides of each panel may have a different fabric within the same grade at no upcharge.
- If different grades of fabric are used on one panel, the entire panel must be priced at highest grade.
- An aluminum low profile top cap is included.
- Stackability: Evolve panels can be increased in height in 6”H, 12”H, 18”H or 24”H increments. See Extension Modules for part numbers.

| | DESCRIPTION | PRODUCT CODE | LIST PRICE | | DIMENSIONS/INCHES | | |
|---|------------------------------|--------------|------------|------|-------------------|----|-------|
| | | | Gr1 | Gr2 | H | W | D |
|  | Open Bottom Panel - 30" High | EVPFOL3018 | 279 | | 30 | 18 | 2 7/8 |
| | | EVPFOL3024 | 317 | | 30 | 24 | 2 7/8 |
| | | EVPFOL3030 | 358 | | 30 | 30 | 2 7/8 |
| | | EVPFOL3036 | 393 | | 30 | 36 | 2 7/8 |
| | | EVPFOL3042 | 431 | | 30 | 42 | 2 7/8 |
| | | EVPFOL3048 | 465 | | 30 | 48 | 2 7/8 |
| | | EVPFOL3054 | 503 | | 30 | 54 | 2 7/8 |
| EVPFOL3060 | 539 | | 30 | 60 | 2 7/8 | | |
|  | Open Bottom Panel - 42" High | EVPFOL4218 | 415 | 423 | 42 | 18 | 2 7/8 |
| | | EVPFOL4224 | 477 | 490 | 42 | 24 | 2 7/8 |
| | | EVPFOL4230 | 539 | 554 | 42 | 30 | 2 7/8 |
| | | EVPFOL4236 | 604 | 622 | 42 | 36 | 2 7/8 |
| | | EVPFOL4242 | 671 | 688 | 42 | 42 | 2 7/8 |
| | | EVPFOL4248 | 721 | 739 | 42 | 48 | 2 7/8 |
| | | EVPFOL4254 | 795 | 813 | 42 | 54 | 2 7/8 |
| EVPFOL4260 | 862 | 883 | 42 | 60 | 2 7/8 | | |
|  | Open Bottom Panel - 54" High | EVPFOL5418 | 469 | 486 | 54 | 18 | 2 7/8 |
| | | EVPFOL5424 | 534 | 558 | 54 | 24 | 2 7/8 |
| | | EVPFOL5430 | 612 | 636 | 54 | 30 | 2 7/8 |
| | | EVPFOL5436 | 685 | 716 | 54 | 36 | 2 7/8 |
| | | EVPFOL5442 | 764 | 797 | 54 | 42 | 2 7/8 |
| | | EVPFOL5448 | 827 | 865 | 54 | 48 | 2 7/8 |
| | | EVPFOL5454 | 905 | 941 | 54 | 54 | 2 7/8 |
| EVPFOL5460 | 978 | 1026 | 54 | 60 | 2 7/8 | | |
|  | Open Bottom Panel - 66" High | EVPFOL6618 | 608 | 634 | 66 | 18 | 2 7/8 |
| | | EVPFOL6624 | 699 | 730 | 66 | 24 | 2 7/8 |
| | | EVPFOL6630 | 799 | 835 | 66 | 30 | 2 7/8 |
| | | EVPFOL6636 | 897 | 938 | 66 | 36 | 2 7/8 |
| | | EVPFOL6642 | 1007 | 1058 | 66 | 42 | 2 7/8 |
| | | EVPFOL6648 | 1078 | 1132 | 66 | 48 | 2 7/8 |
| | | EVPFOL6654 | 1191 | 1250 | 66 | 54 | 2 7/8 |
| EVPFOL6660 | 1297 | 1366 | 66 | 60 | 2 7/8 | | |



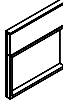
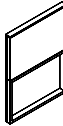

EVPLFOL - OPEN BOTTOM LIGHT PANEL

- Open Bottom Light Panel incorporates bottom 24"H open module with individual fabric modules, within a steel frame.
- The 24"H open bottom module in the base section is to provide air circulation and access to electrical or data.
- There is no base raceway in Light Panels to accommodate electrical.
- Light Panel Connectors must be used in conjunction with Light Panels.
- Opposite sides of each panel may have a different fabric within the same grade at no upcharge.
- If different grades of fabric are used on one panel, the entire panel must be priced at highest grade.
- An aluminum low profile top cap is included.
- Stackability: Evolve panels can be increased in height in 6"H, 12"H, 18"H or 24"H increments. See Extension Modules for part numbers.

| | DESCRIPTION | PRODUCT CODE | LIST PRICE | | DIMENSIONS/INCHES | | |
|---|--------------------------------------|--------------|------------|------|-------------------|----|-------|
| | | | Gr1 | Gr2 | H | W | D |
|  | Open Bottom Light Panel - 30" High | EVPLFOL3018 | 269 | | 30 | 18 | 2 7/8 |
| | | EVPLFOL3024 | 304 | | 30 | 24 | 2 7/8 |
| | | EVPLFOL3030 | 348 | | 30 | 30 | 2 7/8 |
| | | EVPLFOL3036 | 382 | | 30 | 36 | 2 7/8 |
| | | EVPLFOL3042 | 418 | | 30 | 42 | 2 7/8 |
| | | EVPLFOL3048 | 445 | | 30 | 48 | 2 7/8 |
| | | EVPLFOL3054 | 490 | | 30 | 54 | 2 7/8 |
| | | EVPLFOL3060 | 523 | | 30 | 60 | 2 7/8 |
|  | Open Bottom Light Panel - 42" High | EVPLFOL4218 | 401 | 409 | 42 | 18 | 2 7/8 |
| | | EVPLFOL4224 | 462 | 472 | 42 | 24 | 2 7/8 |
| | | EVPLFOL4230 | 523 | 535 | 42 | 30 | 2 7/8 |
| | | EVPLFOL4236 | 587 | 601 | 42 | 36 | 2 7/8 |
| | | EVPLFOL4242 | 649 | 667 | 42 | 42 | 2 7/8 |
| | | EVPLFOL4248 | 703 | 715 | 42 | 48 | 2 7/8 |
| | | EVPLFOL4254 | 769 | 785 | 42 | 54 | 2 7/8 |
| | | EVPLFOL4260 | 834 | 857 | 42 | 60 | 2 7/8 |
|  | Open Bottom Light Panel - 54" High | EVPLFOL5418 | 450 | 464 | 54 | 18 | 2 7/8 |
| | | EVPLFOL5424 | 512 | 533 | 54 | 24 | 2 7/8 |
| | | EVPLFOL5430 | 588 | 607 | 54 | 30 | 2 7/8 |
| | | EVPLFOL5436 | 657 | 685 | 54 | 36 | 2 7/8 |
| | | EVPLFOL5442 | 732 | 764 | 54 | 42 | 2 7/8 |
| | | EVPLFOL5448 | 794 | 828 | 54 | 48 | 2 7/8 |
| | | EVPLFOL5454 | 868 | 906 | 54 | 54 | 2 7/8 |
| | | EVPLFOL5460 | 940 | 983 | 54 | 60 | 2 7/8 |
|  | Open Bottom Premium Panel - 66" High | EVPLFOL6618 | 583 | 605 | 60 | 18 | 2 7/8 |
| | | EVPLFOL6624 | 673 | 702 | 60 | 24 | 2 7/8 |
| | | EVPLFOL6630 | 767 | 800 | 60 | 30 | 2 7/8 |
| | | EVPLFOL6636 | 862 | 900 | 60 | 36 | 2 7/8 |
| | | EVPLFOL6642 | 967 | 1014 | 60 | 42 | 2 7/8 |
| | | EVPLFOL6648 | 1034 | 1087 | 60 | 48 | 2 7/8 |
| | | EVPLFOL6654 | 1142 | 1196 | 60 | 54 | 2 7/8 |
| | | EVPLFOL6660 | 1248 | 1312 | 60 | 60 | 2 7/8 |

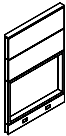

EVFPOL - OPEN BOTTOM PREMIUM PANEL

- Open Bottom Premium Panel incorporates bottom 24”H open module with individual fabric modules, within a steel frame.
- The 24”H open bottom module in the base section is to provide air circulation and access to electrical or data.
- Premium panels incorporate 12”H fabric modules above 30”H base section.
- Opposite sides of each panel may have a different fabric within the same grade at no upcharge.
- If different grades of fabric are used on one panel, the entire panel must be priced at highest grade.
- An aluminum low profile top cap is included.
- Stackability: Evolve panels can be increased in height in 6”H, 12”H, 18”H or 24”H increments. See Extension Modules for part numbers.

| | DESCRIPTION | PRODUCT CODE | LIST PRICE | | DIMENSIONS/INCHES | | |
|---|--------------------------------------|--------------|------------|------|-------------------|-------|-------|
| | | | Gr1 | Gr2 | H | W | D |
|  | Open Bottom Premium Panel - 54” High | EVFPOL5418 | 554 | 570 | 54 | 18 | 2 7/8 |
| | | EVFPOL5424 | 634 | 658 | 54 | 24 | 2 7/8 |
| | | EVFPOL5430 | 725 | 750 | 54 | 30 | 2 7/8 |
| | | EVFPOL5436 | 813 | 841 | 54 | 36 | 2 7/8 |
| | | EVFPOL5442 | 916 | 949 | 54 | 42 | 2 7/8 |
| | | EVFPOL5448 | 982 | 1020 | 54 | 48 | 2 7/8 |
| | | EVFPOL5454 | 1080 | 1120 | 54 | 54 | 2 7/8 |
|  | Open Bottom Premium Panel - 66” High | EVFPOL6618 | 693 | 719 | 66 | 18 | 2 7/8 |
| | | EVFPOL6624 | 800 | 831 | 66 | 24 | 2 7/8 |
| | | EVFPOL6630 | 909 | 944 | 66 | 30 | 2 7/8 |
| | | EVFPOL6636 | 1026 | 1070 | 66 | 36 | 2 7/8 |
| | | EVFPOL6642 | 1158 | 1207 | 66 | 42 | 2 7/8 |
| | | EVFPOL6648 | 1240 | 1295 | 66 | 48 | 2 7/8 |
| | | EVFPOL6654 | 1374 | 1435 | 66 | 54 | 2 7/8 |
| | EVFPOL6660 | 1506 | 1574 | 66 | 60 | 2 7/8 | |

EVPLPOL - OPEN BOTTOM PREMIUM LIGHT PANEL

- Open Bottom Premium Light Panel incorporates bottom 24”H open module with individual fabric modules, within a steel frame.
- The 24”H open bottom module in the base section is to provide air circulation and access to electrical or data.
- Premium panels incorporate 12”H fabric modules above 30”H base section.
- There is no base raceway in Light Panels to accommodate electrical.
- Light Panel Connectors must be used in conjunction with Light Panels.
- Opposite sides of each panel may have a different fabric within the same grade at no upcharge.
- If different grades of fabric are used on one panel, the entire panel must be priced at highest grade.
- An aluminum low profile top cap is included.
- Stackability: Evolve panels can be increased in height in 6”H, 12”H, 18”H or 24”H increments. See Extension Modules for part numbers.

| | DESCRIPTION | PRODUCT CODE | LIST PRICE | | DIMENSIONS/INCHES | | |
|---|--|--------------|------------|------|-------------------|-------|-------|
| | | | Gr1 | Gr2 | H | W | D |
|  | Open Bottom Premium Light Panel - 54” High | EVPLPOL5418 | 531 | 544 | 54 | 18 | 2 7/8 |
| | | EVPLPOL5424 | 608 | 631 | 54 | 24 | 2 7/8 |
| | | EVPLPOL5430 | 696 | 715 | 54 | 30 | 2 7/8 |
| | | EVPLPOL5436 | 780 | 808 | 54 | 36 | 2 7/8 |
| | | EVPLPOL5442 | 878 | 908 | 54 | 42 | 2 7/8 |
| | | EVPLPOL5448 | 942 | 977 | 54 | 48 | 2 7/8 |
| | | EVPLPOL5454 | 1037 | 1074 | 54 | 54 | 2 7/8 |
|  | Open Bottom Premium Light Panel - 66” High | EVPLPOL6618 | 666 | 686 | 60 | 18 | 2 7/8 |
| | | EVPLPOL6624 | 768 | 797 | 60 | 24 | 2 7/8 |
| | | EVPLPOL6630 | 871 | 908 | 60 | 30 | 2 7/8 |
| | | EVPLPOL6636 | 983 | 1022 | 60 | 36 | 2 7/8 |
| | | EVPLPOL6642 | 1111 | 1155 | 60 | 42 | 2 7/8 |
| | | EVPLPOL6648 | 1190 | 1242 | 60 | 48 | 2 7/8 |
| | | EVPLPOL6654 | 1317 | 1375 | 60 | 54 | 2 7/8 |
| | EVPLPOL6660 | 1446 | 1511 | 60 | 60 | 2 7/8 | |



EVVFO - OPEN MIDDLE PANEL - 12”H OPENING

- Open Middle Panel incorporates a 12”H middle position open module with fabric modules, within a steel frame.
- Open Middle Panel Incorporates a 12”H opening above 30”H base module to provide pass-through convenience.
- Opposite sides of each panel may have a different fabric within the same grade at no upcharge.
- If different grades of fabric are used on one panel, the entire panel must be priced at highest grade.
- An aluminum low profile top cap is included.
- Stackability: Evolve panels can be increased in height in 6”H, 12”H, 18”H or 24”H increments. See Extension Modules or part numbers.

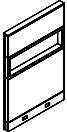
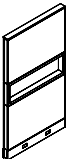
| | DESCRIPTION | PRODUCT CODE | LIST PRICE | | DIMENSIONS/INCHES | | |
|---|---|--------------|------------|------|-------------------|----|-------|
| | | | Gr1 | Gr2 | H | W | D |
|  | Open Middle Panel - 12”H Opening - 54” High | EVVFO5418 | 560 | 587 | 54 | 18 | 2 7/8 |
| | | EVVFO5424 | 652 | 683 | 54 | 24 | 2 7/8 |
| | | EVVFO5430 | 750 | 786 | 54 | 30 | 2 7/8 |
| | | EVVFO5436 | 854 | 897 | 54 | 36 | 2 7/8 |
| | | EVVFO5442 | 961 | 1010 | 54 | 42 | 2 7/8 |
| | | EVVFO5448 | 1037 | 1094 | 54 | 48 | 2 7/8 |
| | | EVVFO5454 | 1150 | 1207 | 54 | 54 | 2 7/8 |
| | | EVVFO5460 | 1257 | 1326 | 54 | 60 | 2 7/8 |
|  | Open Middle Panel - 12”H Opening - 66” High | EVVFO6618 | 618 | 649 | 66 | 18 | 2 7/8 |
| | | EVVFO6624 | 714 | 753 | 66 | 24 | 2 7/8 |
| | | EVVFO6630 | 822 | 869 | 66 | 30 | 2 7/8 |
| | | EVVFO6636 | 932 | 989 | 66 | 36 | 2 7/8 |
| | | EVVFO6642 | 1052 | 1114 | 66 | 42 | 2 7/8 |
| | | EVVFO6648 | 1135 | 1210 | 66 | 48 | 2 7/8 |
| | | EVVFO6654 | 1259 | 1336 | 66 | 54 | 2 7/8 |
| | | EVVFO6660 | 1375 | 1466 | 66 | 60 | 2 7/8 |

EVPLFO - OPEN MIDDLE LIGHT PANEL - 12”H OPENING

- Open Middle Light Panel incorporates a 12”H middle position open module with fabric modules, within a steel frame.
- Open Middle Light Panel Incorporates a 12”H opening above 30”H base module to provide pass-through convenience.
- There is no base raceway in Light Panels to accommodate electrical.
- Light Panel Connectors must be used in conjunction with Light Panels.
- Opposite sides of each panel may have a different fabric within the same grade at no upcharge.
- If different grades of fabric are used on one panel, the entire panel must be priced at highest grade.
- An aluminum low profile top cap is included.
- Stackability: Evolve panels can be increased in height in 6”H, 12”H, 18”H or 24”H increments. See Extension Modules for part numbers.

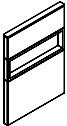
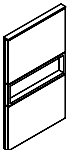
| | DESCRIPTION | PRODUCT CODE | LIST PRICE | | DIMENSIONS/INCHES | | |
|---|---|--------------|------------|------|-------------------|----|-------|
| | | | Gr1 | Gr2 | H | W | D |
|  | Open Middle Light Panel - 12”H Opening - 54” High | EVPLFO5418 | 534 | 556 | 54 | 18 | 2 7/8 |
| | | EVPLFO5424 | 621 | 648 | 54 | 24 | 2 7/8 |
| | | EVPLFO5430 | 714 | 747 | 54 | 30 | 2 7/8 |
| | | EVPLFO5436 | 810 | 849 | 54 | 36 | 2 7/8 |
| | | EVPLFO5442 | 912 | 959 | 54 | 42 | 2 7/8 |
| | | EVPLFO5448 | 984 | 1034 | 54 | 48 | 2 7/8 |
| | | EVPLFO5454 | 1091 | 1146 | 54 | 54 | 2 7/8 |
| | | EVPLFO5460 | 1194 | 1257 | 54 | 60 | 2 7/8 |
|  | Open Middle Light Panel - 12”H Opening - 66” High | EVPLFO6618 | 588 | 616 | 60 | 18 | 2 7/8 |
| | | EVPLFO6624 | 678 | 715 | 60 | 24 | 2 7/8 |
| | | EVPLFO6630 | 779 | 824 | 60 | 30 | 2 7/8 |
| | | EVPLFO6636 | 887 | 939 | 60 | 36 | 2 7/8 |
| | | EVPLFO6642 | 1000 | 1058 | 60 | 42 | 2 7/8 |
| | | EVPLFO6648 | 1078 | 1146 | 60 | 48 | 2 7/8 |
| | | EVPLFO6654 | 1195 | 1270 | 60 | 54 | 2 7/8 |
| | | EVPLFO6660 | 1307 | 1389 | 60 | 60 | 2 7/8 |

EVFPFO - OPEN MIDDLE PREMIUM PANEL - 12”H OPENING

- Open Middle Premium Panel incorporates a 12”H middle position open module with fabric modules, within a steel frame.
- Open Middle Premium Panel Incorporates a 12”H opening above 30”H base module to provide pass-through convenience.
- Premium panels incorporate 12”H modules above 30”H base section.
- Opposite sides of each panel may have a different fabric within the same grade at no upcharge.
- If different grades of fabric are used on one panel, the entire panel must be priced at highest grade.
- An aluminum low profile top cap is included.
- Stackability: Evolve panels can be increased in height in 6”H, 12”H, 18”H or 24”H increments. See Extension Modules for part numbers.

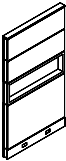
| | DESCRIPTION | PRODUCT CODE | LIST PRICE | | DIMENSIONS/INCHES | | |
|---|--|--------------|------------|------|-------------------|----|-------|
| | | | Gr1 | Gr2 | H | W | D |
|  | Open Middle Premium Panel - 12”H Opening - 66” High | EVFPFO6618 | 703 | 734 | 66 | 18 | 2 7/8 |
| | | EVFPFO6624 | 813 | 857 | 66 | 24 | 2 7/8 |
| | | EVFPFO6630 | 935 | 985 | 66 | 30 | 2 7/8 |
| | | EVFPFO6636 | 1059 | 1113 | 66 | 36 | 2 7/8 |
| | | EVFPFO6642 | 1204 | 1268 | 66 | 42 | 2 7/8 |
| | | EVFPFO6648 | 1294 | 1368 | 66 | 48 | 2 7/8 |
| | | EVFPFO6654 | 1435 | 1514 | 66 | 54 | 2 7/8 |
| | | EVFPFO6660 | 1580 | 1671 | 66 | 60 | 2 7/8 |

EVPLFPO - OPEN MIDDLE PREMIUM LIGHT PANEL - 12” OPENING

- Open Middle Premium Light Panel incorporates a 12”H middle position open module with fabric modules, within a steel frame.
- Open Middle Premium Light Panel Incorporates a 12”H opening above 30”H base module to provide pass-through convenience.
- Premium panels incorporate 12”H modules above 30”H base section.
- There is no base raceway in Light Panels to accommodate electrical.
- Light Panel Connectors must be used in conjunction with Light Panels.
- Opposite sides of each panel may have a different fabric within the same grade at no upcharge.
- If different grades of fabric are used on one panel, the entire panel must be priced at highest grade.
- An aluminum low profile top cap is included.
- Stackability: Evolve panels can be increased in height in 6”H, 12”H, 18”H or 24”H increments. See Extension Modules for part numbers.

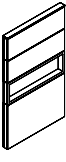
| | DESCRIPTION | PRODUCT CODE | LIST PRICE | | DIMENSIONS/INCHES | | |
|---|--|--------------|------------|------|-------------------|----|-------|
| | | | Gr1 | Gr2 | H | W | D |
|  | Open Middle Premium Light Panel - 12”H Opening - 66” High | EVPLFPO6618 | 667 | 696 | 66 | 18 | 2 7/8 |
| | | EVPLFPO6624 | 774 | 810 | 66 | 24 | 2 7/8 |
| | | EVPLFPO6630 | 888 | 931 | 66 | 30 | 2 7/8 |
| | | EVPLFPO6636 | 1006 | 1055 | 66 | 36 | 2 7/8 |
| | | EVPLFPO6642 | 1144 | 1204 | 66 | 42 | 2 7/8 |
| | | EVPLFPO6648 | 1230 | 1296 | 66 | 48 | 2 7/8 |
| | | EVPLFPO6654 | 1363 | 1436 | 66 | 54 | 2 7/8 |
| | | EVPLFPO6660 | 1501 | 1584 | 66 | 60 | 2 7/8 |



EVFOX - OPEN MIDDLE PANEL - 24”H OPENING

- Open Middle Panel incorporates a 24”H middle position open module with fabric modules, within a steel frame.
- Open Middle Panel Incorporates a 24”H opening above 30”H base module to provide pass-through convenience.
- Opposite sides of each panel may have a different fabric within the same grade at no upcharge.
- If different grades of fabric are used on one panel, the entire panel must be priced at highest grade.
- An aluminum low profile top cap is included.
- Stackability: Evolve panels can be increased in height in 6”H, 12”H, 18”H or 24”H increments. See Extension Modules for part numbers.

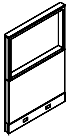
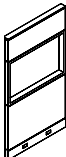
| | DESCRIPTION | PRODUCT CODE | LIST PRICE | | DIMENSIONS/INCHES | | |
|---|---|--------------|------------|------|-------------------|----|-------|
| | | | Gr1 | Gr2 | H | W | D |
|  | Open Middle Panel - 24”H Opening - 54” High | EVFOX5418 | 469 | 486 | 54 | 18 | 2 7/8 |
| | | EVFOX5424 | 534 | 558 | 54 | 24 | 2 7/8 |
| | | EVFOX5430 | 612 | 636 | 54 | 30 | 2 7/8 |
| | | EVFOX5436 | 685 | 716 | 54 | 36 | 2 7/8 |
| | | EVFOX5442 | 763 | 796 | 54 | 42 | 2 7/8 |
| | | EVFOX5448 | 822 | 860 | 54 | 48 | 2 7/8 |
| | | EVFOX5454 | 902 | 940 | 54 | 54 | 2 7/8 |
| | | EVFOX5460 | 978 | 1026 | 54 | 60 | 2 7/8 |
|  | Open Middle Panel - 24”H Opening - 66” High | EVFOX6618 | 608 | 634 | 66 | 18 | 2 7/8 |
| | | EVFOX6624 | 699 | 730 | 66 | 24 | 2 7/8 |
| | | EVFOX6630 | 822 | 860 | 66 | 30 | 2 7/8 |
| | | EVFOX6636 | 897 | 938 | 66 | 36 | 2 7/8 |
| | | EVFOX6642 | 1007 | 1058 | 66 | 42 | 2 7/8 |
| | | EVFOX6648 | 1078 | 1132 | 66 | 48 | 2 7/8 |
| | | EVFOX6654 | 1191 | 1250 | 66 | 54 | 2 7/8 |
| | | EVFOX6660 | 1297 | 1366 | 66 | 60 | 2 7/8 |

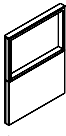
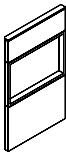

EVPLFOX - OPEN MIDDLE LIGHT PANEL - 24”H OPENING

- Open Middle Panel incorporates a 24”H middle position open module with fabric modules, within a steel frame.
- Open Middle Panel Incorporates a 24”H opening above 30”H base module to provide pass-through convenience.
- There is no base raceway in Light Panels to accommodate electrical.
- Light Panel Connectors must be used in conjunction with Light Panels.
- Opposite sides of each panel may have a different fabric within the same grade at no upcharge.
- If different grades of fabric are used on one panel, the entire panel must be priced at highest grade.
- An aluminum low profile top cap is included.
- Stackability: Evolve panels can be increased in height in 6”H, 12”H, 18”H or 24”H increments. See Extension Modules for part numbers.

| | DESCRIPTION | PRODUCT CODE | LIST PRICE | | DIMENSIONS/INCHES | | |
|---|---|--------------|------------|------|-------------------|----|-------|
| | | | Gr1 | Gr2 | H | W | D |
|  | Open Middle Light Panel - 24”H Opening - 54” High | EVPLFOX5418 | 445 | 459 | 54 | 18 | 2 7/8 |
| | | EVPLFOX5424 | 505 | 527 | 54 | 24 | 2 7/8 |
| | | EVPLFOX5430 | 581 | 601 | 54 | 30 | 2 7/8 |
| | | EVPLFOX5436 | 652 | 678 | 54 | 36 | 2 7/8 |
| | | EVPLFOX5442 | 719 | 750 | 54 | 42 | 2 7/8 |
| | | EVPLFOX5448 | 779 | 813 | 54 | 48 | 2 7/8 |
| | | EVPLFOX5454 | 858 | 896 | 54 | 54 | 2 7/8 |
| | | EVPLFOX5460 | 930 | 972 | 54 | 60 | 2 7/8 |
|  | Open Middle Light Panel - 24”H Opening - 66” High | EVPLFOX6618 | 577 | 600 | 66 | 18 | 2 7/8 |
| | | EVPLFOX6624 | 665 | 693 | 66 | 24 | 2 7/8 |
| | | EVPLFOX6630 | 779 | 813 | 66 | 30 | 2 7/8 |
| | | EVPLFOX6636 | 851 | 888 | 66 | 36 | 2 7/8 |
| | | EVPLFOX6642 | 957 | 1003 | 66 | 42 | 2 7/8 |
| | | EVPLFOX6648 | 1022 | 1074 | 66 | 48 | 2 7/8 |
| | | EVPLFOX6654 | 1130 | 1185 | 66 | 54 | 2 7/8 |
| | | EVPLFOX6660 | 1235 | 1296 | 66 | 60 | 2 7/8 |

EVPFANR - SEGMENTED NO RACEWAY PANEL

- Segmented No Raceway panel incorporates fabric modules within steel frame.
- There is no base raceway in No Raceway Panels to accommodate electric.
- No Raceway connectors to be used.
- Fabric covered modules are tackable and acoustical.
- Each side of fabric module may have different fabric within the same grade at no charge.
- If different grades of fabric are used, the entire module must be price at highest grade.
- Aluminum low profile top and bottom cap is included.
- Stackability: Evolve panels can be increased in height in 6”H, 12”H, 18”H, 24”H increments. See module listing for part numbers See Extension Modules for part numbers.

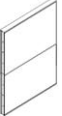
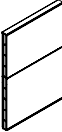
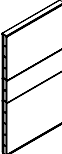
| | DESCRIPTION | PRODUCT CODE | LIST PRICE | | DIMENSIONS/INCHES | | |
|---|-------------------------------|--------------|------------|------|-------------------|----|-------|
| | | | Gr1 | Gr2 | H | W | D |
|  | Segmented NR Panel - 30" High | EVPPFA3018NR | 371 | 385 | 30 | 18 | 2 7/8 |
| | | EVPPFA3024NR | 385 | 407 | 30 | 24 | 2 7/8 |
| | | EVPPFA3030NR | 432 | 453 | 30 | 30 | 2 7/8 |
| | | EVPPFA3036NR | 466 | 494 | 30 | 36 | 2 7/8 |
| | | EVPPFA3042NR | 499 | 533 | 30 | 42 | 2 7/8 |
| | | EVPPFA3048NR | 548 | 588 | 30 | 48 | 2 7/8 |
| | | EVPPFA3054NR | 594 | 634 | 30 | 54 | 2 7/8 |
|  | Segmented NR Panel - 42" High | EVPPFA4218NR | 411 | 435 | 42 | 18 | 2 7/8 |
| | | EVPPFA4224NR | 436 | 466 | 42 | 24 | 2 7/8 |
| | | EVPPFA4230NR | 504 | 542 | 42 | 30 | 2 7/8 |
| | | EVPPFA4236NR | 542 | 587 | 42 | 36 | 2 7/8 |
| | | EVPPFA4242NR | 621 | 666 | 42 | 42 | 2 7/8 |
| | | EVPPFA4248NR | 666 | 721 | 42 | 48 | 2 7/8 |
| | | EVPPFA4254NR | 737 | 800 | 42 | 54 | 2 7/8 |
|  | Segmented NR Panel - 48" High | EVPPFA4818NR | 442 | 475 | 48 | 18 | 2 7/8 |
| | | EVPPFA4824NR | 481 | 523 | 48 | 24 | 2 7/8 |
| | | EVPPFA4830NR | 553 | 600 | 48 | 30 | 2 7/8 |
| | | EVPPFA4836NR | 615 | 674 | 48 | 36 | 2 7/8 |
| | | EVPPFA4842NR | 695 | 763 | 48 | 42 | 2 7/8 |
| | | EVPPFA4848NR | 774 | 847 | 48 | 48 | 2 7/8 |
| | | EVPPFA4854NR | 839 | 918 | 48 | 54 | 2 7/8 |
|  | Segmented NR Panel - 54" High | EVPPFA5418NR | 442 | 475 | 54 | 18 | 2 7/8 |
| | | EVPPFA5424NR | 481 | 523 | 54 | 24 | 2 7/8 |
| | | EVPPFA5430NR | 553 | 600 | 54 | 30 | 2 7/8 |
| | | EVPPFA5436NR | 615 | 674 | 54 | 36 | 2 7/8 |
| | | EVPPFA5442NR | 695 | 763 | 54 | 42 | 2 7/8 |
| | | EVPPFA5448NR | 774 | 847 | 54 | 48 | 2 7/8 |
| | | EVPPFA5454NR | 839 | 918 | 54 | 54 | 2 7/8 |
|  | Segmented NR Panel - 66" High | EVPPFA6618NR | 556 | 596 | 66 | 18 | 2 7/8 |
| | | EVPPFA6624NR | 597 | 648 | 66 | 24 | 2 7/8 |
| | | EVPPFA6630NR | 664 | 721 | 66 | 30 | 2 7/8 |
| | | EVPPFA6636NR | 776 | 849 | 66 | 36 | 2 7/8 |
| | | EVPPFA6642NR | 874 | 956 | 66 | 42 | 2 7/8 |
| | | EVPPFA6648NR | 940 | 1032 | 66 | 48 | 2 7/8 |
| | | EVPPFA6654NR | 1019 | 1121 | 66 | 54 | 2 7/8 |
| EVPPFA6660NR | 1104 | 1216 | 66 | 60 | 2 7/8 | | |





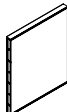
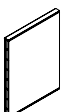
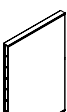
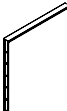
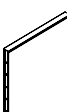

EVPFAMNR - MONOLITHIC NO RACEWAY PANEL

- Monolithic No Raceway panel incorporates fabric modules within steel frame.
- There is no base raceway in No Raceway Panels to accommodate electric.
- No Raceway connectors to be used.
- Fabric covered modules are tackable and acoustical.
- Each side of fabric module may have different fabric within the same grade at no charge.
- If different grades of fabric are used, the entire module must be price at highest grade.
- Aluminum low profile top and bottom cap is included.
- Stackability: Evolve panels can be increased in height in 6”H, 12”H, 18”H, 24”H increments. See module listing for part numbers See Extension Modules for part numbers.

| | DESCRIPTION | PRODUCT CODE | LIST PRICE | | DIMENSIONS/INCHES | | |
|---|--------------------------------|--------------|------------|------|-------------------|----|-------|
| | | | Gr1 | Gr2 | H | W | D |
|  | Monolithic NR Panel 42" High | EVPFAM4218NR | 383 | 416 | 42 | 18 | 2 7/8 |
| | | EVPFAM4224NR | 407 | 446 | 42 | 24 | 2 7/8 |
| | | EVPFAM4230NR | 469 | 517 | 42 | 30 | 2 7/8 |
| | | EVPFAM4236NR | 499 | 556 | 42 | 36 | 2 7/8 |
| | | EVPFAM4242NR | 553 | 622 | 42 | 42 | 2 7/8 |
| | | EVPFAM4248NR | 600 | 678 | 42 | 48 | 2 7/8 |
| | | EVPFAM4254NR | 658 | 744 | 42 | 54 | 2 7/8 |
| | | EVPFAM4260NR | 714 | 807 | 42 | 60 | 2 7/8 |
|  | Monolithic NR Panel - 48" High | EVPFAM4818NR | 388 | 421 | 48 | 18 | 2 7/8 |
| | | EVPFAM4824NR | 425 | 470 | 48 | 24 | 2 7/8 |
| | | EVPFAM4830NR | 493 | 542 | 48 | 30 | 2 7/8 |
| | | EVPFAM4836NR | 536 | 594 | 48 | 36 | 2 7/8 |
| | | EVPFAM4842NR | 597 | 666 | 48 | 42 | 2 7/8 |
| | | EVPFAM4848NR | 648 | 725 | 48 | 48 | 2 7/8 |
| | | EVPFAM4854NR | 717 | 805 | 48 | 54 | 2 7/8 |
| | | EVPFAM4860NR | 779 | 872 | 48 | 60 | 2 7/8 |
|  | Monolithic NR Panel - 54" High | EVPFAM5418NR | 393 | 425 | 54 | 18 | 2 7/8 |
| | | EVPFAM5424NR | 432 | 472 | 54 | 24 | 2 7/8 |
| | | EVPFAM5430NR | 501 | 553 | 54 | 30 | 2 7/8 |
| | | EVPFAM5436NR | 556 | 616 | 54 | 36 | 2 7/8 |
| | | EVPFAM5442NR | 622 | 689 | 54 | 42 | 2 7/8 |
| | | EVPFAM5448NR | 676 | 750 | 54 | 48 | 2 7/8 |
| | | EVPFAM5454NR | 737 | 829 | 54 | 54 | 2 7/8 |
| | | EVPFAM5460NR | 810 | 906 | 54 | 60 | 2 7/8 |
|  | Monolithic NR Panel - 66" High | EVPFAM6618NR | 483 | 517 | 66 | 18 | 2 7/8 |
| | | EVPFAM6624NR | 532 | 574 | 66 | 24 | 2 7/8 |
| | | EVPFAM6630NR | 597 | 649 | 66 | 30 | 2 7/8 |
| | | EVPFAM6636NR | 695 | 753 | 66 | 36 | 2 7/8 |
| | | EVPFAM6642NR | 779 | 847 | 66 | 42 | 2 7/8 |
| | | EVPFAM6648NR | 844 | 919 | 66 | 48 | 2 7/8 |
| | | EVPFAM6654NR | 940 | 1021 | 66 | 54 | 2 7/8 |
| | | EVPFAM6660NR | 1033 | 1124 | 66 | 60 | 2 7/8 |
|  | Monolithic NR Panel - 90" High | EVPFAM9018NR | 849 | 911 | 90 | 18 | 2 7/8 |
| | | EVPFAM9024NR | 919 | 994 | 90 | 24 | 2 7/8 |
| | | EVPFAM9030NR | 1022 | 1118 | 90 | 30 | 2 7/8 |
| | | EVPFAM9036NR | 1190 | 1295 | 90 | 36 | 2 7/8 |

EVPH1SNR - LAMINATE NO RACEWAY - PANEL SINGLE SIDED

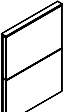

- Laminate No Raceway panel incorporates single sided laminate modules within steel frame.
- Opposite side is fabric covered.
- Laminate faces on all modules provide durable, washable surfaces on One Side of the panel.
- Available in high pressure laminate only.
- If wood grain is selected, grain runs horizontally.
- There is no base raceway in No Raceway Panels to accommodate electric.
- No Raceway connectors to be used.
- If different grades of fabric are used, the entire module must be priced at highest grade.
- An aluminum low profile top and bottom cap is included.
- Stackability: Evolve panels can be increased in height in 6”H, 12”H, 18”H, 24”H increments. See module listing for part numbers.

| | DESCRIPTION | PRODUCT CODE | LIST PRICE | | DIMENSIONS/INCHES | | |
|---|---|--------------|------------|------|-------------------|----|-------|
| | | | Gr1 | Gr2 | H | W | D |
|  | Laminate NR Panel - Single Sided - 30" High | EVPH1S3018NR | 456 | 464 | 30 | 18 | 2 7/8 |
| | | EVPH1S3024NR | 546 | 557 | 30 | 24 | 2 7/8 |
| | | EVPH1S3030NR | 634 | 646 | 30 | 30 | 2 7/8 |
| | | EVPH1S3036NR | 721 | 737 | 30 | 36 | 2 7/8 |
| | | EVPH1S3042NR | 821 | 834 | 30 | 42 | 2 7/8 |
| | | EVPH1S3048NR | 891 | 908 | 30 | 48 | 2 7/8 |
| | | EVPH1S3054NR | 983 | 1007 | 30 | 54 | 2 7/8 |
| | | EVPH1S3060NR | 1081 | 1103 | 30 | 60 | 2 7/8 |
|  | Laminate NR Panel - Single Sided - 42" High | EVPH1S4218NR | 543 | 554 | 42 | 18 | 2 7/8 |
| | | EVPH1S4224NR | 645 | 664 | 42 | 24 | 2 7/8 |
| | | EVPH1S4230NR | 757 | 775 | 42 | 30 | 2 7/8 |
| | | EVPH1S4236NR | 866 | 888 | 42 | 36 | 2 7/8 |
| | | EVPH1S4242NR | 981 | 1007 | 42 | 42 | 2 7/8 |
| | | EVPH1S4248NR | 1067 | 1095 | 42 | 48 | 2 7/8 |
| | | EVPH1S4254NR | 1183 | 1216 | 42 | 54 | 2 7/8 |
| | | EVPH1S4260NR | 1296 | 1334 | 42 | 60 | 2 7/8 |
|  | Laminate NR Panel - Single Sided - 54" High | EVPH1S5418NR | 635 | 646 | 54 | 18 | 2 7/8 |
| | | EVPH1S5424NR | 767 | 788 | 54 | 24 | 2 7/8 |
| | | EVPH1S5430NR | 899 | 922 | 54 | 30 | 2 7/8 |
| | | EVPH1S5436NR | 1028 | 1055 | 54 | 36 | 2 7/8 |
| | | EVPH1S5442NR | 1163 | 1199 | 54 | 42 | 2 7/8 |
| | | EVPH1S5448NR | 1272 | 1311 | 54 | 48 | 2 7/8 |
| | | EVPH1S5454NR | 1413 | 1452 | 54 | 54 | 2 7/8 |
| | | EVPH1S5460NR | 1553 | 1599 | 54 | 60 | 2 7/8 |
|  | Laminate NR Panel - Single Sided - 66" High | EVPH1S6618NR | 786 | 808 | 66 | 18 | 2 7/8 |
| | | EVPH1S6624NR | 945 | 974 | 66 | 24 | 2 7/8 |
| | | EVPH1S6630NR | 1105 | 1140 | 66 | 30 | 2 7/8 |
| | | EVPH1S6636NR | 1275 | 1313 | 66 | 36 | 2 7/8 |
| | | EVPH1S6642NR | 1448 | 1489 | 66 | 42 | 2 7/8 |
| | | EVPH1S6648NR | 1448 | 1489 | 66 | 48 | 2 7/8 |
| | | EVPH1S6654NR | 1757 | 1807 | 66 | 54 | 2 7/8 |
| | | EVPH1S6660NR | 1931 | 1989 | 66 | 60 | 2 7/8 |

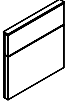
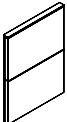

EVPH2SNR - LAMINATE NO RACEWAY - PANEL DOUBLE SIDED

- Laminate No Raceway panel incorporates double sided laminate modules, within steel frame.
- Laminate faces on all modules provide durable, washable surfaces on both sides of the panel.
- Available in high pressure laminate only.
- If wood grain is selected, grain runs horizontally.
- There is no base raceway in No Raceway Panels to accommodate electric.
- No Raceway connectors to be used.
- If different grades of fabric are used, the entire module must be priced at highest grade.
- An aluminum low profile top and bottom cap is included.
- Stackability: Evolve panels can be increased in height in 6”H, 12”H, 18”H, 24”H increments. See module listing for part numbers.

| | DESCRIPTION | PRODUCT CODE | LIST PRICE | DIMENSIONS/INCHES | | |
|---|---|--------------|------------|-------------------|----|-------|
| | | | | H | W | D |
|  | Laminate NR Panel - Double Sided - 30" High | EVPH2S3018NR | 622 | 30 | 18 | 2 7/8 |
| | | EVPH2S3024NR | 622 | 30 | 24 | 2 7/8 |
| | | EVPH2S3030NR | 734 | 30 | 30 | 2 7/8 |
| | | EVPH2S3036NR | 839 | 30 | 36 | 2 7/8 |
| | | EVPH2S3042NR | 954 | 30 | 42 | 2 7/8 |
| | | EVPH2S3048NR | 1066 | 30 | 48 | 2 7/8 |
| | | EVPH2S3054NR | 1181 | 30 | 54 | 2 7/8 |
| EVPH2S3060NR | 1275 | 30 | 60 | 2 7/8 | | |
|  | Laminate NR Panel - Double Sided - 42" High | EVPH2S4218NR | 604 | 42 | 18 | 2 7/8 |
| | | EVPH2S4224NR | 734 | 42 | 24 | 2 7/8 |
| | | EVPH2S4230NR | 865 | 42 | 30 | 2 7/8 |
| | | EVPH2S4236NR | 1004 | 42 | 36 | 2 7/8 |
| | | EVPH2S4242NR | 1144 | 42 | 42 | 2 7/8 |
| | | EVPH2S4248NR | 1282 | 42 | 48 | 2 7/8 |
| | | EVPH2S4254NR | 1410 | 42 | 54 | 2 7/8 |
| EVPH2S4260NR | 1533 | 42 | 60 | 2 7/8 | | |
|  | Laminate NR Panel - Double Sided - 54" High | EVPH2S5418NR | 708 | 54 | 18 | 2 7/8 |
| | | EVPH2S5424NR | 867 | 54 | 24 | 2 7/8 |
| | | EVPH2S5430NR | 1027 | 54 | 30 | 2 7/8 |
| | | EVPH2S5436NR | 1192 | 54 | 36 | 2 7/8 |
| | | EVPH2S5442NR | 1362 | 54 | 42 | 2 7/8 |
| | | EVPH2S5448NR | 1531 | 54 | 48 | 2 7/8 |
| | | EVPH2S5454NR | 1687 | 54 | 54 | 2 7/8 |
| EVPH2S5460NR | 1834 | 54 | 60 | 2 7/8 | | |
|  | Laminate NR Panel - Double Sided - 66" High | EVPH2S6618NR | 891 | 66 | 18 | 2 7/8 |
| | | EVPH2S6624NR | 1095 | 66 | 24 | 2 7/8 |
| | | EVPH2S6630NR | 1296 | 66 | 30 | 2 7/8 |
| | | EVPH2S6636NR | 1504 | 66 | 36 | 2 7/8 |
| | | EVPH2S6642NR | 1723 | 66 | 42 | 2 7/8 |
| | | EVPH2S6648NR | 1931 | 66 | 48 | 2 7/8 |
| | | EVPH2S6654NR | 2132 | 66 | 54 | 2 7/8 |
| EVPH2S6660NR | 2328 | 66 | 60 | 2 7/8 | | |

EVPGTNR - FULLY GLAZED SEGMENTED NO RACEWAY PANEL

- Fully Glazed Segmented No Raceway Panels are incorporated in solid steel frame
- There is no base raceway in No Raceway Panels to accommodate electric
- No Raceway connectors to be used
- Standard in clear (CLR) glass.
- Frosted glass (FRST) 40% upcharge
- Aluminum low profile top and bottom cap is included
- Stackability: Evolve panels can be increased in height in 6”H, 12”H, 18”H, 24”H increments. See module listing for part numbers.

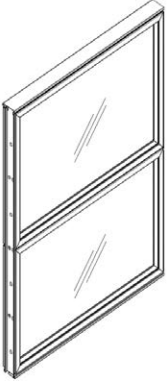
| DESCRIPTION | PRODUCT CODE | LIST PRICE | DIMENSIONS/INCHES | | |
|--|--------------|------------|-------------------|----|-------|
| | | | H | W | D |
|  Glazed Segmented NR Panel 48” H | EVPGT4818NR | 748 | 48 | 18 | 2 7/8 |
| | EVPGT4824NR | 919 | 48 | 24 | 2 7/8 |
| | EVPGT4830NR | 1017 | 48 | 30 | 2 7/8 |
| | EVPGT4836NR | 1110 | 48 | 36 | 2 7/8 |
| | EVPGT4842NR | 1229 | 48 | 42 | 2 7/8 |
| | EVPGT4848NR | 1371 | 48 | 48 | 2 7/8 |
| | EVPGT4854NR | 1509 | 48 | 54 | 2 7/8 |
| | EVPGT4860NR | 1646 | 48 | 60 | 2 7/8 |

EVPXGTNR - FULLY GLAZED MONOLITHIC NO RACEWAY PANEL

- Fully Glazed Monolithic No Raceway Panels are incorporated in solid steel frame.
- There is no base raceway in No Raceway Panels to accommodate electric.
- No Raceway connectors to be used.
- Standard in clear (CLR) glass.
- Frosted glass (FRST) 40% upcharge.
- Size 90”x36”W is maximum size allowed.
- Panel height to align with standard door height.
- Aluminum low profile top and bottom cap is included.
- Stackability: Evolve panels can be increased in height in 6”H, 12”H, 18”H, 24”H increments. See module listing for part numbers.

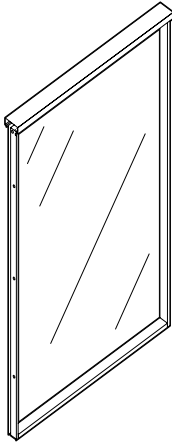
| DESCRIPTION | PRODUCT CODE | LIST PRICE | DIMENSIONS/INCHES | | |
|--|--------------|------------|-------------------|----|-------|
| | | | H | W | D |
|  Glazed Monolithic NR Panel 90” High | EVPXGT9018NR | 951 | 90 | 18 | 2 7/8 |
| | EVPXGT9024NR | 1085 | 90 | 24 | 2 7/8 |
| | EVPXGT9030NR | 1230 | 90 | 30 | 2 7/8 |
| | EVPXGT9036NR | 1330 | 90 | 36 | 2 7/8 |



EVPICNR - INLINE CONNECTOR NO RACEWAY PANEL

- Connects two No Raceway Panels in a straight run.
- Provides slotted support for worksurfaces and hang on components.
- Includes one slotted connector with leveling glide and connecting hardware.
- Connectors are available without slots, as a special at no extra charge. Contact Customer Support.

| | DESCRIPTION | PRODUCT CODE | LIST PRICE | DIMENSIONS/INCHES | | |
|---|---|--------------|------------|-------------------|---|---|
| | | | | H | W | D |
|  | Inline Connector No Raceway Panel | EVPIC30NR | 77 | 30 | 2 | |
| | To be used only with 90" H NR Glazed Panels | EVPIC42NR | 90 | 42 | 2 | |
| | | EVPIC48NR | 94 | 48 | 2 | |
| | | EVPIC54NR | 97 | 54 | 2 | |
| | | EVPIC66NR | 108 | 66 | 2 | |

EVPICNR - INLINE CONNECTOR PANEL - NO RACEWAY PANEL

- Connects Panel to No Raceway panel in straight run.
- Provides slotted support for worksurfaces and hang on components.
- Includes one slotted connector with leveling glide and connecting hardware.
- Connectors are available without slots, as a special at no extra charge. Contact Customer Support.
- Note: Allows to connect panel to NR panel in straight run.

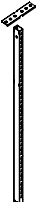
| | DESCRIPTION | PRODUCT CODE | LIST PRICE | DIMENSIONS/INCHES | | |
|--|---|--------------|------------|-------------------|---|---|
| | | | | H | W | D |
|  | Inline Connector Panel - No Raceway Panel | EVPIC30PNR | 74 | 30 | 2 | |
| | | EVPIC42PNR | 86 | 42 | 2 | |
| | | EVPIC48PNR | 90 | 48 | 2 | |
| | | EVPIC54PNR | 92 | 54 | 2 | |
| | | EVPIC66PNR | 102 | 66 | 2 | |

EVPIC90NR - INLINE CONNECTOR NO RACEWAY PANEL

- Connects two 90" H No Raceway panel in straight run.
- Includes one slotted connector with leveling glide and connecting hardware.
- Connectors are without slots
- To be used only with 90" H NR Glazed Panels.

| | DESCRIPTION | PRODUCT CODE | LIST PRICE | DIMENSIONS/INCHES | | |
|---|-----------------------------------|--------------|------------|-------------------|---|---|
| | | | | H | W | D |
|  | Inline Connector No Raceway Panel | EVPIC90NR | 162 | 90 | 2 | |

EVVIC90PNR - INLINE CONNECTOR PANEL - NO RACEWAY PANEL

- Connects 90" H No Raceway panel to 90" H door in straight run.
- Includes one non slotted connector with leveling glide and connecting hardware
- Connectors are without slots.
- Note: To be used only with 90" H NR Glazed Panels and 90" H door

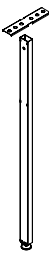
| | DESCRIPTION | PRODUCT CODE | LIST PRICE | DIMENSIONS/INCHES | | |
|---|---|--------------|------------|-------------------|---|---|
| | | | | H | W | D |
|  | Inline Connector Panel - No Raceway Panel | EVVIC90PNR | 162 | 90 | 2 | |

EVVPCNR - INLINE VARIABLE HEIGHT CONNECTOR NO RACEWAY PANEL

- Connects two No Raceway panels of differing height in straight run.
- Connector must reference taller panel.
- Can be used for any variation of panel height.
- Variable height trim must be ordered separately (see EVPTVA).
- Provides slotted support for worksurfaces and hang on components.
- Includes one slotted connector with leveling glide and connecting hardware.
- Connectors are available without slots, as a special at no extra charge. Contact customer support..

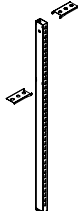
| | DESCRIPTION | PRODUCT CODE | LIST PRICE | DIMENSIONS/INCHES | | |
|--|---|--------------|------------|-------------------|---|---|
| | | | | H | W | D |
|  | Inline Variable Height Connector No Raceway Panel | EVVPC42NR | 97 | 42 | 2 | |
| | | EVVPC48NR | 99 | 48 | 2 | |
| | | EVVPC54NR | 101 | 54 | 2 | |
| | | EVVPC66NR | 109 | 66 | 2 | |

EVVPCPNR - INLINE VARIABLE HEIGHT CONNECTOR PANEL - NO RACEWAY PANEL

- Connects Panel to No Raceway panels of differing height in straight run.
- Connector must reference taller panel.
- Can be used for any variation of panel height.
- Variable height trim must be ordered separately (see EVPTVA).
- Provides slotted support for worksurfaces and hang on components.
- Includes one slotted connector with leveling glide and connecting hardware.
- Connectors are available without slots, as a special at no extra charge. Contact customer support.
- Note: Allows to connect panel to NR panel in straight run

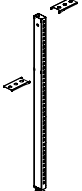
| | DESCRIPTION | PRODUCT CODE | LIST PRICE | DIMENSIONS/INCHES | | |
|---|---|--------------|------------|-------------------|---|---|
| | | | | H | W | D |
|  | Inline Variable Height Connector Panel - No Raceway Panel | EVVPC42PNR | 102 | 42 | 2 | |
| | | EVVPC48PNR | 109 | 48 | 2 | |
| | | EVVPC54PNR | 123 | 54 | 2 | |
| | | EVVPC66PNR | 136 | 66 | 2 | |



EVPERANR - END OF RUN POST KIT FOR NO RACEWAY PANEL

- Connects at end of No Raceway panel and can attach to a panel to fixed wall.
- Adds 1" to width of panel run.
- Provides slotted support for worksurfaces and hang on components.
- Includes one slotted connector with leveling glide and connecting hardware and glide and connecting hardware and trim kit.
- Can be attached to face of another panel to provide off modular connection.
- Connectors are available without slots, as a special at no extra charge. Contact customer support.

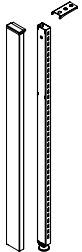
| DESCRIPTION | PRODUCT CODE | LIST PRICE | DIMENSIONS/INCHES | | |
|--|--------------|------------|-------------------|---|---|
| | | | H | W | D |
|  End End of Run Post Kit No Raceway Panel | EVPERA30NR | 94 | 30 | 2 | |
| | EVPERA42NR | 108 | 42 | 2 | |
| | EVPERA48NR | 114 | 48 | 2 | |
| | EVPERA54NR | 128 | 54 | 2 | |
| | EVPERA66NR | 142 | 66 | 2 | |

EVPERA90NR - END OF RUN POST KIT FOR NO RACEWAY PANEL

- Connects two 90" H No Raceway panel and can attach to a panel to fixed wall.
- Adds 1" to width of panel run.
- Includes Non-Slotted connector with leveling glide and connecting hardware and trim kit.
- Can be attached to face of another panel to provide off modular connection.
- Connectors are without slots.
- To be used only with 90" H NR Glazed Panels.

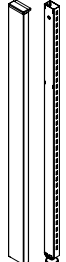
| DESCRIPTION | PRODUCT CODE | LIST PRICE | DIMENSIONS/INCHES | | |
|--|--------------|------------|-------------------|---|---|
| | | | H | W | D |
|  End End of Run Post Kit To be used only with 90" H NR Glazed Panels | EVPERA90NR | 203 | 66 | 2 | |

EVPCPA1NR - ONE WAY CORNER POST NO RACEWAY PANEL

- Connects at end of No Raceway panel run in place of EVPERA- End of run post kit.
- Should not be used to attach panel to fixed wall.
- Post and connecting hardware add 3.25" to power beam run.
- Provides slotted support for worksurfaces and hang on components.
- Includes post, panel connectors and power beam connectors, post with trim all around, levelling glide, hardware and trim kit.
- Connectors are available without slots, as a special at no extra charge. Contact customer support.

| | DESCRIPTION | PRODUCT CODE | LIST PRICE | DIMENSIONS/INCHES | | |
|---|---------------------|--------------|------------|-------------------|-------|---|
| | | | | H | W | D |
|  | One Way Corner Post | EVPCPA130NR | 125 | 30 | 2 7/8 | |
| | No Raceway Panel | EVPCPA142NR | 142 | 42 | 2 7/8 | |
| | | EVPCPA148NR | 167 | 48 | 2 7/8 | |
| | | EVPCPA154NR | 190 | 54 | 2 7/8 | |
| | | EVPCPA166NR | 233 | 66 | 2 7/8 | |

EVPCPA190NR - ONE WAY CORNER POST NO RACEWAY PANEL

- Connects at end of 90" H No Raceway panel run in place of EVPERA - End of run post kit.
- Should not be used to attach panel to fixed wall.
- Post and connecting hardware add 3.25" to power beam run.
- Includes post, panel connectors and power beam connectors, post with trim all around, levelling glide, hardware and trim kit.
- Connectors are without slots.
- To be used only with 90" H NR Glazed Panels.

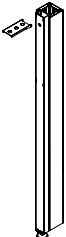
| | DESCRIPTION | PRODUCT CODE | LIST PRICE | DIMENSIONS/INCHES | | |
|--|--|--------------|------------|-------------------|-------|---|
| | | | | H | W | D |
|  | One Way Corner Post No Raceway Panel To be used only with 90" H NR Glazed Panels | EVPCPA190NR | 344 | 90 | 2 7/8 | |



EVPIPA2NR - INLINE TWO WAY CORNER POST NO RACEWAY PANEL

- Connects two No Raceway panel of equal height in straight run.
- Post and connecting hardware add 3.25" to power beam run.
- Provides slotted support for worksurfaces and hang on components.
- Includes post, panel connectors and power beam connectors, post with trim all around, levelling glide, hardware and trim kit.
- Connectors are available without slots, as a special at no extra charge. Contact customer support.

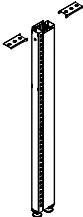
| | DESCRIPTION | PRODUCT CODE | LIST PRICE | DIMENSIONS/INCHES | | |
|---|----------------------------|--------------|------------|-------------------|-------|---|
| | | | | H | W | D |
|  | Inline Two Way Corner Post | EVPIPA230NR | 171 | 30 | 2 7/8 | |
| | No Raceway Panel | EVPIPA242NR | 216 | 42 | 2 7/8 | |
| | | EVPIPA248NR | 236 | 48 | 2 7/8 | |
| | | EVPIPA254NR | 258 | 54 | 2 7/8 | |
| | | EVPIPA266NR | 306 | 66 | 2 7/8 | |

EVPIPA290NR - INLINE TWO WAY CORNER POST NO RACEWAY PANEL

- Connects two No Raceway panel of equal height in a straight run.
- Post and connecting hardware add 3.25" to power beam run.
- Includes post, panel connectors and power beam connectors, post with trim all around, levelling glide, hardware and trim kit.
- Connectors are without slots.
- To be used only with 90" H NR Glazed Panels.

| | DESCRIPTION | PRODUCT CODE | LIST PRICE | DIMENSIONS/INCHES | | |
|--|---|--------------|------------|-------------------|-------|---|
| | | | | H | W | D |
|  | Inline Two Way Corner Post | EVPIPA290NR | 460 | 90 | 2 7/8 | |
| | No Raceway Panel | | | | | |
| | To be used only with 90" H NR Glazed Panels | | | | | |

EVPCPA2PNR - TWO WAY CORNER POST NO RACEWAY PANEL-PANEL

- Connects No Raceway panel and Raceway Panel of equal height in 90 degree configuration.
- Post and connecting hardware add 3.25" to power beam run.
- Provides slotted support for worksurfaces and hang on components.
- Includes post, panel connectors and power beam connectors, post with trim all around, levelling glide, hardware and trim kit.
- Connectors are available without slots, as a special at no extra charge. Contact customer support.

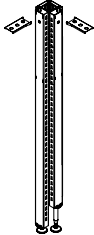
| | DESCRIPTION | PRODUCT CODE | LIST PRICE | DIMENSIONS/INCHES | | |
|---|---------------------|--------------|------------|-------------------|-------|---|
| | | | | H | W | D |
|  | Two Way Corner Post | EVPCPA230PNR | 175 | 30 | 2 7/8 | |
| | No Raceway Panel | EVPCPA242PNR | 219 | 42 | 2 7/8 | |
| | | EVPCPA248PNR | 233 | 48 | 2 7/8 | |
| | | EVPCPA254PNR | 270 | 54 | 2 7/8 | |
| | | EVPCPA266PNR | 321 | 66 | 2 7/8 | |

EVPCPA290NR - TWO WAY CORNER POST NO RACEWAY PANEL

- Connects two 90" H No Raceway panels of equal height in "T" configuration.
- Post and connecting hardware add 3.25" to power beam run.
- Includes post, panel connectors and power beam connectors, post with trim all around, levelling glide, hardware and trim kit.
- Connectors are without slots.
- To be used only with 90" H NR Glazed Panels.

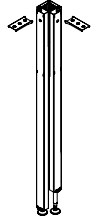
| | DESCRIPTION | PRODUCT CODE | LIST PRICE | DIMENSIONS/INCHES | | |
|--|--|--------------|------------|-------------------|-------|---|
| | | | | H | W | D |
|  | Two Way Corner Post No Raceway Panel To be used only with 90" H NR Glazed Panels | EVPCPA290NR | 461 | 90 | 2 7/8 | |



EVPCPA3PNR - THREE WAY CORNER POST NO RACEWAY PANEL-PANEL-NO RACEWAY PANEL

- Connects two No Raceway panels and Raceway Panels of equal height in "T" configuration.
- Post and connecting hardware add 3.25" to power beam run.
- Provides slotted support for worksurfaces and hang on components.
- Includes post, panel connectors and power beam connectors, post with trim all around, levelling glide, hardware and trim kit.
- Connectors are available without slots, as a special at no extra charge. Contact customer support.

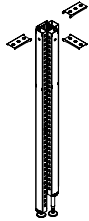

| DESCRIPTION | PRODUCT CODE | LIST PRICE | DIMENSIONS/INCHES | | |
|-----------------------|--------------|------------|-------------------|-------|---|
| | | | H | W | D |
| Three Way Corner Post | EVPCPA330PNR | 218 | 30 | 2 7/8 | |
| No Raceway Panel | EVPCPA342PNR | 291 | 42 | 2 7/8 | |
| | EVPCPA348PNR | 321 | 48 | 2 7/8 | |
| | EVPCPA354PNR | 352 | 54 | 2 7/8 | |
| | EVPCPA366PNR | 415 | 66 | 2 7/8 | |

EVPCPA3PNRP - THREE WAY CORNER POST PANEL-NO RACEWAY PANEL-PANEL

- Connects two panels and No raceway Panel of equal height in "T" configuration.
- Post and connecting hardware add 3.25" to power beam run.
- Provides slotted support for worksurfaces and hang on components.
- Includes post, panel connectors and power beam connectors, post with trim all around, levelling glide, hardware and trim kit.
- Connectors available without slots, as a special at no extra charge. Contact CustomerCare

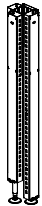

| DESCRIPTION | PRODUCT CODE | LIST PRICE | DIMENSIONS/INCHES | | |
|-----------------------|---------------|------------|-------------------|-------|---|
| | | | H | W | D |
| Three Way Corner Post | EVPCPA330PNRP | 218 | 30 | 2 7/8 | |
| No Raceway Panel | EVPCPA342PNRP | 291 | 42 | 2 7/8 | |
| | EVPCPA348PNRP | 321 | 48 | 2 7/8 | |
| | EVPCPA354PNRP | 352 | 54 | 2 7/8 | |
| | EVPCPA366PNRP | 415 | 66 | 2 7/8 | |

EVPCPA390NR - THREE WAY CORNER POST NO RACEWAY PANEL

- Connects two 90" H No Raceway panels of equal height in "T" configuration.
- Post and connecting hardware add 3.25" to power beam run.
- Includes post, panel connectors and power beam connectors, post with trim all around, levelling glide, hardware and trim kit.
- Connectors are without slots.
- To be used only with 90" H NR Glazed Panels.

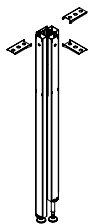

| DESCRIPTION | PRODUCT CODE | LIST PRICE | DIMENSIONS/INCHES | | |
|---|--------------|------------|-------------------|-------|---|
| | | | H | W | D |
| Three Way Corner Post | EVPCPA390NR | 582 | 90 | 2 7/8 | |
| No Raceway Panel | | | | | |
| To be used only with 90" H NR Glazed Panels | | | | | |

EVPCPA4PNR - FOUR WAY CORNER POST NO RACEWAY PANEL-PANEL-NO RACEWAY PANEL-PANEL

- Connects two No Raceway panels and two Raceway panels of equal height in "+" configuration.
- Post and connecting hardware add 3.25" to power beam run.
- Provides slotted support for worksurfaces and hang on components.
- Includes post, panel connectors and power beam connectors, post with trim all around, levelling glide, hardware and trim kit.
- Connectors are available without slots, as a special at no extra charge. Contact customer support.

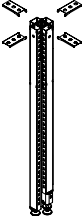
| | DESCRIPTION | PRODUCT CODE | LIST PRICE | DIMENSIONS/INCHES | | |
|---|----------------------|--------------|------------|-------------------|-------|---|
| | | | | H | W | D |
|  | Four Way Corner Post | EVPCPA430PNR | 267 | 30 | 2 7/8 | |
| | No Raceway Panel | EVPCPA442PNR | 341 | 42 | 2 7/8 | |
| | | EVPCPA448PNR | 378 | 48 | 2 7/8 | |
| | | EVPCPA454PNR | 412 | 54 | 2 7/8 | |
| | | EVPCPA466PNR | 483 | 66 | 2 7/8 | |

EVPCPA490NR - FOUR WAY CORNER POST NO RACEWAY PANEL

- Connects four 90" H No Raceway panels of equal height in "+" configuration.
- Post and connecting hardware add 3.25" to power beam run.
- Includes post, panel connectors and power beam connectors, post with trim all around, levelling glide, hardware and trim kit.
- Connectors are without slots.
- To be used only with 90" H NR Glazed Panels.

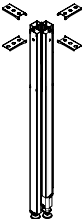
| | DESCRIPTION | PRODUCT CODE | LIST PRICE | DIMENSIONS/INCHES | | |
|--|---|--------------|------------|-------------------|-------|---|
| | | | | H | W | D |
|  | Four Way Corner Post No Raceway Panel To be used only with 90" H NR Glazed Panels | EVPCPA490NR | 668 | 90 | 2 7/8 | |



EVLEPDSNC - LAMINATE DOUBLE SIDED GALLERY PANEL, FINISHED ENDS

- Attaches to end of run connector with "U" channel.
- To be installed at end of panel run.
- Finished in thermally fused laminate.
- No connection on both sides.
- Laminate Gallery Panel height is inclusive of panel glides extended to their full height.
- If wood grain is selected, grain runs horizontally.
- End of run connector with "U" channel and bottom connecting brackets to be ordered separately.

| | DESCRIPTION | PRODUCT CODE | LIST PRICE LP | DIMENSIONS/INCHES | | |
|---|-------------------------------------|---------------|------------------|-------------------|----|---|
| | | | | H | W | D |
|  | Laminate Double Sided Gallery Panel | EVLEPDS4251NC | 692 | 42 | 51 | 1 |
| | Finished Ends - 42" High | EVLEPDS4263NC | 901 | 42 | 63 | 1 |
| | | EVLEPDS4275NC | 1110 | 42 | 75 | 1 |
| | Laminate Double Sided Gallery Panel | EVLEPDS4851NC | 754 | 48 | 51 | 1 |
| | Finished Ends - 48" High | EVLEPDS4863NC | 999 | 48 | 63 | 1 |
| | | EVLEPDS4875NC | 1214 | 48 | 75 | 1 |
| | Laminate Double Sided Gallery Panel | EVLEPDS5451NC | 875 | 54 | 51 | 1 |
| | Finished Ends - 54" High | EVLEPDS5463NC | 1143 | 54 | 63 | 1 |
| | | EVLEPDS5475NC | 1322 | 54 | 75 | 1 |





EVLEPDS - LAMINATE DOUBLE SIDED GALLERY PANEL, CONNECTOR ENDS

- Attaches to end of run connector with "U" channel.
- To be installed at end of panel run.
- Finished in thermally fused laminate.
- Locking connection both sides.
- Laminate Gallery Extension Panel height is inclusive of panel glides extended to their full height.
- If wood grain is selected, grain runs horizontally.
- End of run connector with "U" channel and bottom connecting brackets to be ordered separately.

| | DESCRIPTION | PRODUCT CODE | LIST PRICE LP | DIMENSIONS/INCHES | | |
|---|-----------------------------------|--------------|------------------|-------------------|----|---|
| | | | | H | W | D |
|  | Laminate Double Sided Gallery | EVLEPDS4251 | 692 | 42 | 51 | 1 |
| | Panel - Connector Ends - 42" High | EVLEPDS4263 | 901 | 42 | 63 | 1 |
| | | EVLEPDS4275 | 1110 | 42 | 75 | 1 |
| | Laminate Double Sided Gallery | EVLEPDS4851 | 754 | 48 | 51 | 1 |
| | Panel - Connector Ends - 48" High | EVLEPDS4863 | 999 | 48 | 63 | 1 |
| | | EVLEPDS4875 | 1214 | 48 | 75 | 1 |
| | Laminate Double Sided Gallery | EVLEPDS5451 | 875 | 54 | 51 | 1 |
| | Panel - Connector Ends - 54" High | EVLEPDS5463 | 1143 | 54 | 63 | 1 |
| | | EVLEPDS5475 | 1322 | 54 | 75 | 1 |

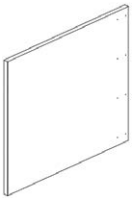
EVLEPSSNC - LAMINATE SINGLE SIDED GALLERY PANEL, FINISHED ENDS

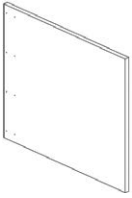

- Attaches to end of run connector with "U" channel.
- To be installed at end of panel run on one side.
- Finished in thermally fused laminate.
- No connection both sides.
- Laminate Gallery Extension Panel height is inclusive of panel glides extended to their full height.
- If wood grain is selected, grain runs horizontally.
- End of run connector with "U" channel and bottom connecting brackets to be ordered separately.

| | DESCRIPTION | PRODUCT CODE | LIST PRICE LP | DIMENSIONS/INCHES | | |
|---|--|----------------|------------------|-------------------|----|---|
| | | | | H | W | D |
|  | Laminate Single Sided Gallery Panel - Finished Ends - 42" High | EVLEPSSL4227NC | 450 | 42 | 27 | 1 |
| | | EVLEPSSL4233NC | 502 | 42 | 33 | 1 |
| | | EVLEPSSL4239NC | 564 | 42 | 39 | 1 |
| | | EVLEPSSL4245NC | 646 | 42 | 45 | 1 |
| | | EVLEPSSL4251NC | 692 | 42 | 51 | 1 |
|  | Laminate Single Sided Gallery Panel - Finished Ends - 48" High | EVLEPSSL4827NC | 492 | 48 | 27 | 1 |
| | | EVLEPSSL4833NC | 558 | 48 | 33 | 1 |
| | | EVLEPSSL4839NC | 625 | 48 | 39 | 1 |
| | | EVLEPSSL4845NC | 692 | 48 | 45 | 1 |
| | | EVLEPSSL4851NC | 784 | 48 | 51 | 1 |
|  | Laminate Single Sided Gallery Panel - Finished Ends - 54" High | EVLEPSSL5427NC | 541 | 54 | 27 | 1 |
| | | EVLEPSSL5433NC | 618 | 54 | 33 | 1 |
| | | EVLEPSSL5439NC | 704 | 54 | 39 | 1 |
| | | EVLEPSSL5445NC | 824 | 54 | 45 | 1 |
| | | EVLEPSSL5451NC | 875 | 54 | 51 | 1 |
|  | Laminate Single Sided Gallery Panel - Finished Ends - 42" High | EVLEPSSR4227NC | 450 | 42 | 27 | 1 |
| | | EVLEPSSR4233NC | 502 | 42 | 33 | 1 |
| | | EVLEPSSR4239NC | 564 | 42 | 39 | 1 |
| | | EVLEPSSR4245NC | 646 | 42 | 45 | 1 |
| | | EVLEPSSR4251NC | 692 | 42 | 51 | 1 |
|  | Laminate Single Sided Gallery Panel - Finished Ends - 48" High | EVLEPSSR4827NC | 492 | 48 | 27 | 1 |
| | | EVLEPSSR4833NC | 558 | 48 | 33 | 1 |
| | | EVLEPSSR4839NC | 625 | 48 | 39 | 1 |
| | | EVLEPSSR4845NC | 692 | 48 | 45 | 1 |
| | | EVLEPSSR4851NC | 784 | 48 | 51 | 1 |
|  | Laminate Single Sided Gallery Panel - Finished Ends - 54" High | EVLEPSSR5427NC | 754 | 54 | 27 | 1 |
| | | EVLEPSSR5433NC | 618 | 54 | 33 | 1 |
| | | EVLEPSSR5439NC | 704 | 54 | 39 | 1 |
| | | EVLEPSSR5445NC | 824 | 54 | 45 | 1 |
| | | EVLEPSSR5451NC | 875 | 54 | 51 | 1 |

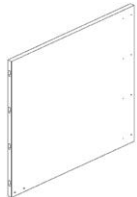
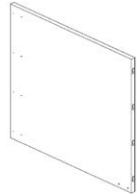

EVLEPSS - LAMINATE SINGLE SIDED GALLERY PANEL, CONNECTOR END

- Attaches to end of run connector with "U" channel.
- To be installed at end of panel run on one side.
- Finished in thermally fused laminate.
- Locking connection on one side.
- Laminate Gallery Extension Panel height is inclusive of panel glides extended to their full height.
- If wood grain is selected, grain runs horizontally.
- End of run connector with "U" channel and bottom connecting brackets to be ordered separately

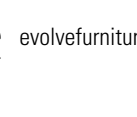
| | DESCRIPTION | PRODUCT CODE | LIST PRICE | DIMENSIONS/INCHES | | |
|---|--|--------------|------------|-------------------|----|---|
| | | | LP | H | W | D |
|  | Laminate Single Sided Gallery Panel - Connector Ends - 42" High | EVLEPSSL4227 | 450 | 42 | 27 | 1 |
| | | EVLEPSSL4233 | 502 | 42 | 33 | 1 |
| | | EVLEPSSL4239 | 564 | 42 | 39 | 1 |
| | | EVLEPSSL4245 | 646 | 42 | 45 | 1 |
| | | EVLEPSSL4251 | 692 | 42 | 51 | 1 |
|  | Laminate Single Sided Gallery Pannel - Connector Ends - 48" High | EVLEPSSL4827 | 492 | 48 | 27 | 1 |
| | | EVLEPSSL4833 | 558 | 48 | 33 | 1 |
| | | EVLEPSSL4839 | 625 | 48 | 39 | 1 |
| | | EVLEPSSL4845 | 692 | 42 | 45 | 1 |
| | | EVLEPSSL4851 | 784 | 42 | 51 | 1 |
|  | Laminate Single Sided Gallery Pannel - Connector Ends - 54" High | EVLEPSSL5427 | 541 | 54 | 27 | 1 |
| | | EVLEPSSL5433 | 618 | 54 | 33 | 1 |
| | | EVLEPSSL5439 | 704 | 42 | 39 | 1 |
| | | EVLEPSSL5445 | 824 | 54 | 45 | 1 |
| | | EVLEPSSL5451 | 875 | 42 | 51 | 1 |
|  | Laminate Single Sided Gallery Pannel - Connector Ends - 42" High | EVLEPSSR4227 | 450 | 42 | 27 | 1 |
| | | EVLEPSSR4233 | 502 | 42 | 33 | 1 |
| | | EVLEPSSR4239 | 564 | 42 | 39 | 1 |
| | | EVLEPSSR4245 | 646 | 42 | 45 | 1 |
| | | EVLEPSSR4251 | 692 | 42 | 51 | 1 |
|  | Laminate Single Sided Gallery Pannel - Connector Ends - 48" High | EVLEPSSR4827 | 492 | 48 | 27 | 1 |
| | | EVLEPSSR4833 | 558 | 48 | 33 | 1 |
| | | EVLEPSSR4839 | 625 | 48 | 39 | 1 |
| | | EVLEPSSR4845 | 692 | 42 | 45 | 1 |
| | | EVLEPSSR4851 | 784 | 42 | 51 | 1 |
| | Laminate Single Sided Gallery Pannel - Connector Ends - 54" High | EVLEPSSR5427 | 541 | 54 | 27 | 1 |
| | | EVLEPSSR5433 | 618 | 54 | 33 | 1 |
| | | EVLEPSSR5439 | 704 | 54 | 39 | 1 |
| | | EVLEPSSR5445 | 824 | 42 | 45 | 1 |
| | | EVLEPSSR5451 | 875 | 42 | 51 | 1 |

EVLEPDCNC - LAMINATE DOUBLE SIDED MIDDLE GALLERY PANEL, BASE POWER, FINISHED ENDS

- Attaches in middle of panel run with connector with "U" channel.
- To be installed in middle between two panels in straight run.
- Finished in thermally fused laminate.
- Locking connection on both side.
- Laminate Gallery Panel height is inclusive of panel glides extended to their full height.
- If wood grain is selected, grain runs horizontally.
- End of run connector with "U" channel and bottom connecting brackets to be ordered separately.

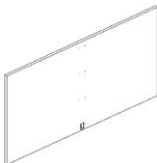
| | DESCRIPTION | PRODUCT CODE | LIST PRICE LP | DIMENSIONS/INCHES | | |
|---|---|---------------|------------------|-------------------|----|---|
| | | | | H | W | D |
|  | Laminate Double Sided Gallery Panel Finished Ends - 42" High | EVLEPDC4251NC | 875 | 42 | 51 | 1 |
| | | EVLEPDC4263NC | 901 | 42 | 63 | 1 |
| | | EVLEPDC4275NC | 1110 | 42 | 75 | 1 |
| | Laminate Double Sided Gallery Panel Finished Ends - 48" High | EVLEPDC4851NC | 754 | 48 | 51 | 1 |
| | | EVLEPDC4863NC | 999 | 48 | 63 | 1 |
| | | EVLEPDC4875NC | 1214 | 48 | 75 | 1 |
| | Laminate Double Sided Gallery Panel Finished Ends - 54" High | EVLEPDC4851NC | 754 | 54 | 51 | 1 |
| | | EVLEPDC4863NC | 999 | 54 | 63 | 1 |
| | | EVLEPDC4875NC | 1214 | 54 | 75 | 1 |

EVICLXPNC - LAMINATE DOUBLE SIDED MIDDLE GALLERY PANEL, BELTLINE POWER, FINISHED ENDS

- Attaches in middle of panel run with connector with "U" channel
- To be installed in middle between two beltline panels in straight run .
- Finished in thermally fused laminate.
- No connection both sides.
- Laminate Gallery Panel height is inclusive of panel glides extended to their full height.
- If wood grain is selected, grain runs horizontally.
- End of run connector with "U" channel and bottom connecting brackets to be ordered separately.

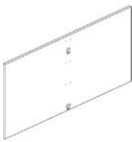
| | DESCRIPTION | PRODUCT CODE | LIST PRICE LP | DIMENSIONS/INCHES | | |
|---|--|---------------|------------------|-------------------|----|---|
| | | | | H | W | D |
|  | Laminate Double Sided Middle Gallery Panel - Finished Ends - 42" High | EVICLXP4251NC | 692 | 42 | 51 | 1 |
| | | EVICLXP4263NC | 901 | 42 | 63 | 1 |
| | | EVICLXP4275NC | 1110 | 42 | 75 | 1 |
| | Laminate Double Sided Middle Gallery Panel - Finished Ends - 48" High | EVICLXP4851NC | 754 | 48 | 51 | 1 |
| | | EVICLXP4863NC | 999 | 48 | 63 | 1 |
| | | EVICLXP4875NC | 1214 | 48 | 75 | 1 |
| | Laminate Double Sided Middle Gallery Panel - Finished Ends - 54" High | EVICLXP5451NC | 875 | 54 | 51 | 1 |
| | | EVICLXP5463NC | 1143 | 54 | 63 | 1 |
| | | EVICLXP5475NC | 1322 | 54 | 75 | 1 |



EVLEPDC - LAMINATE DOUBLE SIDED MIDDLE GALLERY PANEL, BASE POWER, CONNECTOR ENDS

- Attaches to end of run connector with "U" channel.
- To be installed in middle between two panels in straight run.
- Finished in thermally fused laminate.
- Locking connection both sides.
- Laminate Gallery Extension Panel height is inclusive of panel glides extended to their full height.
- If wood grain is selected, grain runs horizontally.
- End of run connector with "U" channel and bottom connecting brackets to be ordered separately.

| | DESCRIPTION | PRODUCT CODE | LIST PRICE | DIMENSIONS/INCHES | | |
|---|---|--------------|------------|-------------------|----|---|
| | | | LP | H | W | D |
|  | Laminate Double Sided Middle Gallery Panel - Connector End - 42" High | EVLEPDC4251 | 692 | 42 | 51 | 1 |
| | | EVLEPDC4263 | 901 | 42 | 63 | 1 |
| | | EVLEPDC4275 | 1110 | 42 | 75 | 1 |
| | Laminate Single Sided Middle Gallery Panel - Connector End - 48" High | EVLEPDC4851 | 754 | 48 | 51 | 1 |
| | | EVLEPDC4863 | 999 | 48 | 63 | 1 |
| | | EVLEPDC4875 | 1214 | 48 | 75 | 1 |
| | Laminate Single Sided Middle Gallery Panel - Connector End - 54" High | EVLEPDC5451 | 875 | 54 | 51 | 1 |
| | | EVLEPDC5463 | 1143 | 54 | 63 | 1 |
| | | EVLEPDC5475 | 1322 | 54 | 75 | 1 |

EVICLXP - LAMINATE DOUBLE SIDED MIDDLE GALLERY PANEL, BELTLINE POWER, CONNECTOR ENDS

- Attaches in middle of panel run with connector with "U" channel.
- To be installed in middle between two panels in straight run on one side.
- Finished in thermally fused laminate.
- Locking connection on both sides.
- Laminate Gallery Panel height is inclusive of panel glides extended to their full height.
- If wood grain is selected, grain runs horizontally.
- End of run connector with "U" channel and bottom connecting brackets to be ordered separately.

| | DESCRIPTION | PRODUCT CODE | LIST PRICE | DIMENSIONS/INCHES | | |
|---|---|--------------|------------|-------------------|----|---|
| | | | LP | H | W | D |
|  | Laminate Double Sided Gallery Panel Connector Ends - 42" High | EVICLXP4251 | 692 | 42 | 51 | 1 |
| | | EVICLXP4263 | 901 | 42 | 63 | 1 |
| | | EVICLXP4275 | 1110 | 42 | 75 | 1 |
| | Laminate Double Sided Gallery Panel Connector Ends - 48" High | EVICLXP4851 | 754 | 48 | 51 | 1 |
| | | EVICLXP4863 | 999 | 48 | 63 | 1 |
| | | EVICLXP4875 | 1214 | 48 | 75 | 1 |
| | Laminate Double Sided Gallery Panel Connector Ends - 54" High | EVICLXP5451 | 875 | 54 | 51 | 1 |
| | | EVICLXP5463 | 1143 | 54 | 63 | 1 |
| | | EVICLXP5475 | 1322 | 42 | 75 | 1 |

EVLEPSCNC - LAMINATE SINGLE SIDED MIDDLE GALLERY PANEL, BASE POWER, FINISHED ENDS

- Attaches in middle of panel run with connector with "U" channel.
- To be installed in middle between two panels in straight run on one side.
- Cut out for electrics at base height.
- Finished in thermally fused laminate.
- No connection both sides.
- Laminate Gallery Panel height is inclusive of panel glides extended to their full height.
- If wood grain is selected, grain runs horizontally.
- End of run connector with "U" channel and bottom connecting brackets to be ordered separately.

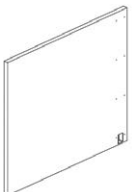
| | DESCRIPTION | PRODUCT CODE | LIST PRICE LP | DIMENSIONS/INCHES | | |
|---|---|---------------|------------------|-------------------|----|---|
| | | | | H | W | D |
|  | Laminate Single Sided Gallery Panel - Finished End - 42" High | EVLEPSC4227NC | 450 | 42 | 27 | 1 |
| | | EVLEPSC4233NC | 502 | 42 | 33 | 1 |
| | | EVLEPSC4239NC | 564 | 42 | 39 | 1 |
| | | EVLEPSC4245NC | 646 | 42 | 45 | 1 |
| | | EVLEPSC4251NC | 692 | 42 | 51 | 1 |
| | Laminate Single Sided Gallery Panel - Finished End - 48" High | EVLEPSC4827NC | 492 | 48 | 27 | 1 |
| | | EVLEPSC4833NC | 558 | 48 | 33 | 1 |
| | | EVLEPSC4839NC | 625 | 48 | 39 | 1 |
| | | EVLEPSC4845NC | 692 | 48 | 45 | 1 |
| | | EVLEPSC4851NC | 784 | 48 | 51 | 1 |
| | Laminate Single Sided Gallery Panel - Finished End - 54" High | EVLEPSC5427NC | 541 | 54 | 27 | 1 |
| | | EVLEPSC5433NC | 618 | 54 | 33 | 1 |
| | | EVLEPSC5439NC | 704 | 54 | 39 | 1 |
| | | EVLEPSC5445NC | 824 | 54 | 45 | 1 |
| | | EVLEPSC5451NC | 875 | 54 | 51 | 1 |

EVLEPSC - LAMINATE SINGLE SIDED MIDDLE GALLERY PANEL, BASE POWER, CONNECTOR END

- Attaches in middle of panel run with connector with "U" channel.
- To be installed in middle between two panels in straight run on one side.
- Finished in thermally fused laminate.
- Locking connection on one side.
- Laminate Gallery Panel height is inclusive of panel glides extended to their full height.
- If wood grain is selected, grain runs horizontally.
- End of run connector with "U" channel and bottom connecting brackets to be ordered separately.

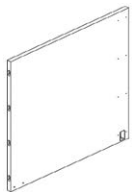
| | DESCRIPTION | PRODUCT CODE | LIST PRICE LP | DIMENSIONS/INCHES | | |
|---|--|--------------|------------------|-------------------|----|---|
| | | | | H | W | D |
|  | Laminate Single Sided Middle Gallery Panel - Connector Ends - 42" High | EVLEPSC4227 | 450 | 42 | 27 | 1 |
| | | EVLEPSC4233 | 502 | 42 | 33 | 1 |
| | | EVLEPSC4239 | 564 | 42 | 39 | 1 |
| | | EVLEPSC4245 | 646 | 42 | 45 | 1 |
| | | EVLEPSC4251 | 692 | 42 | 51 | 1 |
| | Laminate Single Sided Middle Gallery Panel - Connector Ends - 48" High | EVLEPSC4827 | 492 | 48 | 27 | 1 |
| | | EVLEPSC4833 | 558 | 48 | 33 | 1 |
| | | EVLEPSC4839 | 625 | 48 | 39 | 1 |
| | | EVLEPSC4845 | 692 | 42 | 45 | 1 |
| | | EVLEPSC4851 | 784 | 42 | 51 | 1 |
| | Laminate Single Sided Middle Gallery Panel - Connector Ends - 54" High | EVLEPSC5427 | 541 | 54 | 27 | 1 |
| | | EVLEPSC5433 | 618 | 54 | 33 | 1 |
| | | EVLEPSC5439 | 704 | 42 | 39 | 1 |
| | | EVLEPSC5445 | 824 | 54 | 45 | 1 |
| | | EVLEPSC5451 | 875 | 42 | 51 | 1 |



EVLEPSCNC - LAMINATE SINGLE SIDED MIDDLE GALLERY PANEL, BELTLINE POWER, FINISHED ENDS

- Attaches in middle of panel run with connector with "U" channel.
- To be installed in middle between two beltline panels in straight run.
- Cut out for electrics at beltline height.
- Finished in thermally fused laminate.
- No connection both sides.
- Laminate Gallery Panel height is inclusive of panel glides extended to their full height.
- If wood grain is selected, grain runs horizontally.
- End of run connector with "U" channel and bottom connecting brackets to be ordered separately.

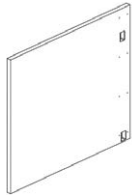
| | DESCRIPTION | PRODUCT CODE | LIST PRICE | DIMENSIONS/INCHES | | |
|---|---|----------------|------------|-------------------|----|---|
| | | | LP | H | W | D |
|  | Laminate Single Sided Gallery Panel Finished Ends - 42" High | EVLEPSCB4227NC | 450 | 42 | 27 | 1 |
| | | EVLEPSCB4233NC | 502 | 42 | 33 | 1 |
| | | EVLEPSCB4239NC | 564 | 42 | 39 | 1 |
| | | EVLEPSCB4245NC | 692 | 42 | 45 | 1 |
| | | EVLEPSCB4251NC | 692 | 42 | 51 | 1 |
| | Laminate Single Sided Gallery Panel Finished Ends - 48" High | EVLEPSCB4827NC | 492 | 48 | 27 | 1 |
| | | EVLEPSCB4833NC | 558 | 48 | 33 | 1 |
| | | EVLEPSCB4839NC | 625 | 48 | 39 | 1 |
| | | EVLEPSCB4845NC | 692 | 48 | 45 | 1 |
| | | EVLEPSCB4851NC | 784 | 48 | 51 | 1 |
| | Laminate Single Sided Gallery Panel Finished Ends - 54" High | EVLEPSCB5427NC | 541 | 54 | 27 | 1 |
| | | EVLEPSCB5433NC | 618 | 54 | 33 | 1 |
| | | EVLEPSCB5439NC | 704 | 54 | 39 | 1 |
| | | EVLEPSCB5445NC | 824 | 54 | 45 | 1 |
| | | EVLEPSCB5451NC | 875 | 54 | 51 | 1 |

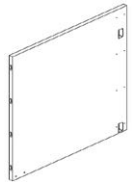

EVLEPSC - LAMINATE SINGLE SIDED MIDDLE GALLERY PANEL, BELTLINE POWER, CONNECTOR END

- Attaches in middle of panel run with connector with "U" channel.
- To be installed in middle between two panels in straight run on one side.
- Finished in thermally fused laminate.
- Locking connection on one side.
- Laminate Gallery Panel height is inclusive of panel glides extended to their full height.
- If wood grain is selected, grain runs horizontally.
- End of run connector with "U" channel and bottom connecting brackets to be ordered separately.

| | DESCRIPTION | PRODUCT CODE | LIST PRICE | DIMENSIONS/INCHES | | |
|---|---|--------------|------------|-------------------|----|---|
| | | | LP | H | W | D |
|  | Laminate Single Sided Middle Gallery Panel - Connector Ends - 42" High | EVLEPSCB4227 | 450 | 42 | 27 | 1 |
| | | EVLEPSCB4233 | 502 | 42 | 33 | 1 |
| | | EVLEPSCB4239 | 564 | 42 | 39 | 1 |
| | | EVLEPSCB4245 | 646 | 42 | 45 | 1 |
| | | EVLEPSCB4251 | 692 | 42 | 51 | 1 |
| | Laminate Single Sided Middle Gallery Panel - Connector Ends - 48" High | EVLEPSCB4827 | 492 | 48 | 27 | 1 |
| | | EVLEPSCB4833 | 558 | 48 | 33 | 1 |
| | | EVLEPSCB4839 | 625 | 48 | 39 | 1 |
| | | EVLEPSCB4845 | 692 | 48 | 45 | 1 |
| | | EVLEPSCB4851 | 784 | 48 | 51 | 1 |
| | Laminate Single Sided Middle Gallery Panel - Connector Ends - 54" High | EVLEPSCB5427 | 541 | 54 | 27 | 1 |
| | | EVLEPSCB5433 | 618 | 54 | 33 | 1 |
| | | EVLEPSCB5439 | 704 | 54 | 39 | 1 |
| | | EVLEPSCB5445 | 824 | 54 | 45 | 1 |
| | | EVLEPSCB5451 | 875 | 42 | 51 | 1 |

EVLXPMNC - LAMINATE GALLERY EXTENSION PANEL, FINISHED END



- Locking connection on one side, no connection at end.
- Finished in thermally fused laminate.
- Laminate Gallery Extension Panel height is inclusive of panel glides extended to their full height.
- If wood grain is selected, grain runs horizontally.
- Bottom connecting brackets to be ordered separately.

| | DESCRIPTION | PRODUCT CODE | LIST PRICE LP | DIMENSIONS/INCHES | | |
|--|----------------------------------|----------------|------------------|-------------------|----|---|
| | | | | H | W | D |
|  | Laminate Gallery Extension Panel | EVLXPMML4224NC | 369 | 42 | 24 | 1 |
| | Finished End - 42" High | EVLXPMML4230NC | 450 | 42 | 30 | 1 |
| | | EVLXPMML4236NC | 502 | 42 | 36 | 1 |
| | | EVLXPMML4242NC | 563 | 42 | 42 | 1 |
| | | EVLXPMML4248NC | 645 | 42 | 48 | 1 |
| | Laminate Gallery Extension Panel | EVLXPMML4824NC | 424 | 48 | 24 | 1 |
| | Finished End - 48" High | EVLXPMML4830NC | 492 | 48 | 30 | 1 |
| | | EVLXPMML4836NC | 558 | 48 | 36 | 1 |
| | | EVLXPMML4842NC | 625 | 48 | 42 | 1 |
| | | EVLXPMML4848NC | 692 | 48 | 48 | 1 |
| | Laminate Gallery Extension Panel | EVLXPMML5424NC | 754 | 54 | 24 | 1 |
| | Finished End - 54" High | EVLXPMML5430NC | 541 | 54 | 30 | 1 |
| | | EVLXPMML5436NC | 618 | 54 | 36 | 1 |
| | | EVLXPMML5442NC | 704 | 54 | 42 | 1 |
| | | EVLXPMML5448NC | 824 | 54 | 48 | 1 |
|  | Laminate Gallery Extension Panel | EVLXPMR4224NC | 369 | 42 | 24 | 1 |
| | Finished End - 42" High | EVLXPMR4230NC | 450 | 42 | 30 | 1 |
| | | EVLXPMR4236NC | 502 | 42 | 36 | 1 |
| | | EVLXPMR4242NC | 563 | 42 | 42 | 1 |
| | | EVLXPMR4248NC | 645 | 42 | 48 | 1 |
| | Laminate Gallery Extension Panel | EVLXPMR4824NC | 424 | 48 | 24 | 1 |
| | Finished End - 48" High | EVLXPMR4830NC | 492 | 48 | 30 | 1 |
| | | EVLXPMR4836NC | 558 | 48 | 36 | 1 |
| | | EVLXPMR4842NC | 625 | 48 | 42 | 1 |
| | | EVLXPMR4848NC | 692 | 48 | 48 | 1 |
| | Laminate Gallery Extension Panel | EVLXPMR5424NC | 462 | 54 | 24 | 1 |
| | Finished End - 54" High | EVLXPMR5430NC | 541 | 54 | 30 | 1 |
| | | EVLXPMR5436NC | 618 | 54 | 36 | 1 |
| | | EVLXPMR5442NC | 704 | 54 | 42 | 1 |
| | | EVLXPMR5448NC | 824 | 54 | 48 | 1 |





EVLXPM - LAMINATE GALLERY STRAIGHT EXTENSION PANEL, CONNECTOR ENDS

- Locking connection both sides.
- Finished in thermally fused laminate.
- Laminate Gallery Panel height is inclusive of panel glides extended to their full height.
- If wood grain is selected, grain runs horizontally.
- Bottom connecting brackets to be ordered separately.

| | DESCRIPTION | PRODUCT CODE | LIST PRICE LP | DIMENSIONS/INCHES | | |
|--|---|--------------|------------------|-------------------|----|---|
| | | | | H | W | D |
|  | Laminate Gallery Straight Extension | EVLXPML4224 | 692 | 42 | 24 | 1 |
| | Panel - Connector Ends - Left - 42" High | EVLXPML4230 | 450 | 42 | 30 | 1 |
| | | EVLXPML4236 | 502 | 42 | 36 | 1 |
| | | EVLXPML4242 | 563 | 42 | 42 | 1 |
| | | EVLXPML4248 | 645 | 42 | 48 | 1 |
| | Laminate Gallery Straight Extension | EVLXPML4824 | 424 | 48 | 24 | 1 |
| | Panel - Connector Ends - Left - 48" High | EVLXPML4830 | 492 | 48 | 30 | 1 |
| | | EVLXPML4836 | 558 | 48 | 36 | 1 |
| | | EVLXPML4842 | 625 | 48 | 42 | 1 |
| | | EVLXPML4848 | 692 | 48 | 48 | 1 |
| | Laminate Gallery Straight Extension | EVLXPML5424 | 462 | 54 | 24 | 1 |
| | Panel - Connector Ends - Left - 54" High | EVLXPML5430 | 541 | 54 | 30 | 1 |
| | | EVLXPML5436 | 618 | 54 | 36 | 1 |
| | | EVLXPML5442 | 704 | 54 | 42 | 1 |
| | | EVLXPML5448 | 824 | 54 | 48 | 1 |
|  | Laminate Gallery Straight Extension | EVLXPMR4224 | 369 | 42 | 24 | 1 |
| | Panel - Connector Ends - Right - 42" High | EVLXPMR4230 | 450 | 42 | 30 | 1 |
| | | EVLXPMR4236 | 502 | 42 | 36 | 1 |
| | | EVLXPMR4242 | 563 | 42 | 42 | 1 |
| | | EVLXPMR4248 | 645 | 42 | 48 | 1 |
| | Laminate Gallery Straight Extension | EVLXPMR4824 | 424 | 48 | 24 | 1 |
| | Panel - Connector Ends - Right - 48" High | EVLXPMR4830 | 492 | 48 | 30 | 1 |
| | | EVLXPMR4836 | 558 | 48 | 36 | 1 |
| | | EVLXPMR4842 | 625 | 48 | 42 | 1 |
| | | EVLXPMR4848 | 692 | 48 | 48 | 1 |
| | Laminate Gallery Straight Extension | EVLXPMR5424 | 462 | 54 | 24 | 1 |
| | Panel - Connector Ends - Right - 54" High | EVLXPMR5430 | 541 | 54 | 30 | 1 |
| | | EVLXPMR5436 | 618 | 54 | 36 | 1 |
| | | EVLXPMR5442 | 704 | 54 | 42 | 1 |
| | | EVLXPMR5448 | 824 | 54 | 48 | 1 |

EV2LXP - LAMINATE GALLERY TWO-WAY EXTENSION PANEL, FINISHED ENDS

- Panel connects at 90 degree with extension panel.
- Finished in thermally fused laminate.
- Laminate Gallery Extension Panel height is inclusive of panel glides extended to their full height.
- If wood grain is selected, grain runs horizontally.
- Corner connecting brackets to be ordered separately.

| | DESCRIPTION | PRODUCT CODE | LIST PRICE LP | DIMENSIONS/INCHES | | |
|--|---|--------------|------------------|-------------------|----|---|
| | | | | H | W | D |
|  | Laminate Gallery Two-Way Extension Panel - Finished Ends - Left - 42" High | EV2LXPL4225 | 371 | 42 | 25 | 1 |
| | | EV2LXPL4231 | 450 | 42 | 31 | 1 |
| | | EV2LXPL4237 | 502 | 42 | 37 | 1 |
| | | EV2LXPL4243 | 564 | 42 | 43 | 1 |
| | | EV2LXPL4249 | 646 | 42 | 49 | 1 |
| | Laminate Gallery Two-Way Extension Panel - Finished Ends - Left - 48" High | EV2LXPL4825 | 424 | 48 | 25 | 1 |
| | | EV2LXPL4831 | 492 | 48 | 31 | 1 |
| | | EV2LXPL4837 | 558 | 48 | 37 | 1 |
| | | EV2LXPL4843 | 625 | 48 | 43 | 1 |
| | | EV2LXPL4849 | 692 | 48 | 49 | 1 |
| | Laminate Gallery Two-Way Extension Panel - Finished Ends - Left - 54" High | EV2LXPL5425 | 497 | 54 | 25 | 1 |
| | | EV2LXPL5431 | 568 | 54 | 31 | 1 |
| | | EV2LXPL5437 | 638 | 54 | 37 | 1 |
| | | EV2LXPL5443 | 776 | 54 | 43 | 1 |
| | | EV2LXPL5449 | 875 | 54 | 49 | 1 |
|  | Laminate Gallery Two-Way Extension Panel - Finished Ends - Right - 42" High | EV2LXPR4225 | 371 | 42 | 25 | 1 |
| | | EV2LXPR4231 | 450 | 42 | 33 | 1 |
| | | EV2LXPR4237 | 502 | 42 | 37 | 1 |
| | | EV2LXPR4243 | 564 | 42 | 43 | 1 |
| | | EV2LXPR4249 | 646 | 42 | 49 | 1 |
| | Laminate Gallery Two-Way Extension Panel - Finished Ends - Right - 48" High | EV2LXPR4825 | 424 | 48 | 25 | 1 |
| | | EV2LXPR4831 | 492 | 48 | 33 | 1 |
| | | EV2LXPR4837 | 558 | 48 | 37 | 1 |
| | | EV2LXPR4843 | 625 | 48 | 43 | 1 |
| | | EV2LXPR4849 | 692 | 48 | 49 | 1 |
| | Laminate Gallery Two-Way Extension Panel - Finished Ends - Right - 54" High | EV2LXPR5425 | 497 | 54 | 25 | 1 |
| | | EV2LXPR5431 | 568 | 54 | 31 | 1 |
| | | EV2LXPR5437 | 638 | 54 | 37 | 1 |
| | | EV2LXPR5443 | 776 | 54 | 43 | 1 |
| | | EV2LXPR5449 | 875 | 54 | 49 | 1 |



EV3LXP - LAMINATE GALLERY THREE-WAY EXTENSION PANEL, FINISHED ENDS

- Panel connects "T" configuration with extension panel.
- Finished in thermally fused laminate.
- Laminate Gallery Extension Panel height is inclusive of panel glides extended to their full height.
- If wood grain is selected, grain runs horizontally.
- Corner connecting brackets to be ordered separately.

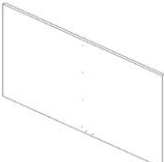
| | DESCRIPTION | PRODUCT CODE | LIST PRICE LP | DIMENSIONS/INCHES | | |
|---|--|--------------|------------------|-------------------|----|---|
| | | | | H | W | D |
|  | Laminate Gallery Three-Way Extension Panel - Finished Ends - Left - 42" High | EV3LXPL4249 | 692 | 42 | 49 | 1 |
| | | EV3LXPL4261 | 824 | 42 | 61 | 1 |
| | | EV3LXPL4273 | 959 | 42 | 73 | 1 |
| | Laminate Gallery Three-Way Extension Panel - Finished Ends - Left - 48" High | EV3LXPL4849 | 784 | 48 | 49 | 1 |
| | | EV3LXPL4861 | 963 | 48 | 61 | 1 |
| | | EV3LXPL4873 | 1143 | 48 | 73 | 1 |
| | Laminate Gallery Three-Way Extension Panel - Finished Ends - Left - 54" High | EV3LXPL5449 | 875 | 54 | 49 | 1 |
| | | EV3LXPL5461 | 1143 | 54 | 61 | 1 |
| | | EV3LXPL5473 | 1322 | 54 | 73 | 1 |
|  | Laminate Gallery Three-Way Extension Panel - Finished Ends - Left - 42" High | EV3LXPR4249 | 692 | 42 | 49 | 1 |
| | | EV3LXPR4261 | 824 | 42 | 61 | 1 |
| | | EV3LXPR4273 | 959 | 42 | 73 | 1 |
| | Laminate Gallery Three-Way Extension Panel - Finished Ends - Left - 48" High | EV3LXPR4849 | 784 | 48 | 49 | 1 |
| | | EV3LXPR4861 | 963 | 48 | 61 | 1 |
| | | EV3LXPR4873 | 1143 | 48 | 73 | 1 |
| | Laminate Gallery Three-Way Extension Panel - Finished Ends - Left - 54" High | EV3LXPR5449 | 875 | 54 | 49 | 1 |
| | | EV3LXPR5461 | 1143 | 54 | 61 | 1 |
| | | EV3LXPR5473 | 1322 | 54 | 73 | 1 |

EV4LXP - LAMINATE DOUBLE GALLERY PANEL FOR FOUR-WAY, FINISHED ENDS

- Panel connects "+" configuration with extension panel.
- Finished in thermally fused laminate.
- Laminate Gallery Extension Panel height is inclusive of panel glides extended to their full height.
- If wood grain is selected, grain runs horizontally.
- Corner connecting brackets to be ordered separately

| | DESCRIPTION | PRODUCT CODE | LIST PRICE LP | DIMENSIONS/INCHES | | |
|---|-------------------------------------|--------------|------------------|-------------------|----|---|
| | | | | H | W | D |
|  | Laminate Double Gallery Panel | EV4LXP4249 | 692 | 42 | 49 | 1 |
| | Four-Way - Finished Ends - 42" High | EV4LXP4261 | 901 | 42 | 61 | 1 |
| | | EV4LXP4273 | 1110 | 42 | 73 | 1 |
| | Laminate Double Gallery Panel | EV4LXP4849 | 754 | 48 | 49 | 1 |
| | Four-Way - Finished Ends - 48" High | EV4LXP4861 | 999 | 48 | 61 | 1 |
| | | EV4LXP4873 | 1214 | 48 | 73 | 1 |
| | Laminate Double Gallery Panel | EV4LXP5449 | 875 | 54 | 49 | 1 |
| | Four-Way - Finished Ends - 48" High | EV4LXP5461 | 1143 | 54 | 61 | 1 |
| | | EV4LXP5473 | 1322 | 54 | 73 | 1 |

EV4LXPM - LAMINATE GALLERY EXTENSION PANEL FOR FOUR-WAY CONFIGURATION, FINISHED ENDS

- Locking connection on one side only for four way panel.
- Finished in thermally fused laminate.
- Universal to be used on both sides of four way laminate panel.
- Laminate Gallery Extension Panel height is inclusive of panel glides extended to their full height.
- If wood grain is selected, grain runs horizontally.
- Bottom connecting brackets to be ordered separately.

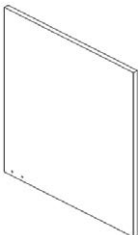
| | DESCRIPTION | PRODUCT CODE | LIST PRICE LP | DIMENSIONS/INCHES | | |
|---|-------------------------------------|--------------|------------------|-------------------|----|---|
| | | | | H | W | D |
|  | Laminate Gallery Extension Panel | EV4LXPM4224 | 369 | 42 | 24 | 1 |
| | Four-Way - Finished Ends - 42" High | EV4LXPM4230 | 450 | 42 | 30 | 1 |
| | | EV4LXPM4236 | 502 | 42 | 36 | 1 |
| | | EV4LXPM4242 | 563 | 42 | 42 | 1 |
| | | EV4LXPM4248 | 645 | 42 | 58 | 1 |
| | Laminate Gallery Extension Panel | EV4LXPM4824 | 424 | 48 | 24 | 1 |
| | Four-Way - Finished Ends - 42" High | EV4LXPM4830 | 492 | 48 | 30 | 1 |
| | | EV4LXPM4836 | 558 | 48 | 36 | 1 |
| | | EV4LXPM4842 | 625 | 48 | 42 | 1 |
| | | EV4LXPM4848 | 692 | 48 | 48 | 1 |
| | Laminate Gallery Extension Panel | EV4LXPM5424 | 462 | 54 | 24 | 1 |
| | Four-Way - Finished Ends - 42" High | EV4LXPM5430 | 541 | 54 | 30 | 1 |
| | | EV4LXPM5436 | 618 | 54 | 36 | 1 |
| | | EV4LXPM5442 | 704 | 54 | 42 | 1 |
| | | EV4LXPM5448 | 824 | 54 | 48 | 1 |



EVERPERCH - EVOLVE PANEL CONNECTOR WITH U CHANNEL

- U channel attaches with screws to laminate end panel or laminate middle panel.
- Evolve panels attaches to connector.
- Pass thru at bottom and beltline location for power/data.
- U channel is welded to connector.
- Includes connector with U channel and hardware.

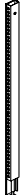
| | DESCRIPTION | PRODUCT CODE | LIST PRICE | DIMENSIONS/INCHES | | |
|---|-----------------|--------------|------------|-------------------|-------|---|
| | | | LP | H | W | D |
|  | Panel Connector | EVERPERCH42 | 172 | 42 | 2.875 | 1 |
| | U Channel | EVERPERCH48 | 185 | 48 | 2.875 | 1 |
| | | EVERPERCH54 | 200 | 54 | 2.875 | 1 |

EVPBERCH - EVOLVE PANEL CONNECTOR WITH U CHANNEL FOR BELTLINE PANELS

- U channel attaches with screws to laminate middle panel.
- Evolve panels attaches to connector.
- Pass thru at bottom and beltline location for power/data.
- U channel is welded to connector.
- Includes connector with U channel and hardware.

| | DESCRIPTION | PRODUCT CODE | LIST PRICE | DIMENSIONS/INCHES | | |
|--|-----------------|--------------|------------|-------------------|-------|---|
| | | | LP | H | W | D |
|  | Panel Connector | EVPBERCH42 | 172 | 42 | 2.875 | 1 |
| | U Channel | EVPBERCH48 | 185 | 48 | 2.875 | 1 |
| | | EVPBERCH54 | 200 | 54 | 2.875 | 1 |

EVERPERCHNR - NO RACEWAY PANEL CONNECTOR WITH U CHANNEL

- U channel attaches with screws to laminate end panel or laminate middle panel.
- Evolve NR panels attaches to connector.
- U channel is welded to NR connector.
- Includes NR connector with U channel and hardware.

| | DESCRIPTION | PRODUCT CODE | LIST PRICE | DIMENSIONS/INCHES | | |
|---|-------------------------------------|---------------|------------|-------------------|-------|---|
| | | | LP | H | W | D |
|  | No Raceway Connector with U Channel | EVERPERCH42NR | 172 | 42 | 2.875 | 1 |
| | | EVERPERCH48NR | 185 | 48 | 2.875 | 1 |
| | | EVERPERCH54NR | 200 | 54 | 2.875 | 1 |

EVPGDCP - GALLERY PANEL DATA POST / COMM LAY-IN

- One way post attaches to Gallery Panel at the end to bring power and/or data cables from ceiling to Evolve panels.
- Accommodates up to 25 CAT 5 cables with electric. Accommodates up to 45 CAT 5 cables without electric.
- Middle Gallery panel with bottom cut out for electric must be ordered.
- Standard data post extension used above.
- Standard data post extension to be ordered separately.

| | DESCRIPTION | PRODUCT CODE | LIST PRICE | DIMENSIONS/INCHES | | |
|---|-------------|--------------|------------|-------------------|---|---|
| | | | LP | H | W | D |
|  | Data Post | EVPGDCP42 | 230 | 42 | 3 | |
| | | EVPGDCP48 | 270 | 48 | 3 | |
| | | EVPGDCP54 | 295 | 54 | 3 | |

EVHLPBB01 - LAMINATE GALLERY PANEL BOTTOM BRACKET

- Laminate panel bottom bracket connects two laminate end panels at bottom with screws. • Bracket and screws included
- Available in standard paint colors.

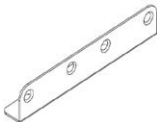
| DESCRIPTION | PRODUCT CODE | LIST PRICE LP | DIMENSIONS/INCHES | | |
|--|--------------|------------------|-------------------|---|---|
| | | | H | W | D |
|  Bottom Bracket | EVHLPBB01 | 47 | 1.5 | 8 | 1 |

EVHLPB01 - LAMINATE GALLERY PANEL CORNER BRACKET

- Laminate panel corner bottom bracket connects two laminate panels at 90 degree. • Bracket and screws included.
- Available in standard paint colors.

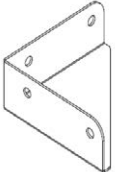
| DESCRIPTION | PRODUCT CODE | LIST PRICE LP | DIMENSIONS/INCHES | | |
|--|--------------|------------------|-------------------|---|---|
| | | | H | W | D |
|  Corner Bracket | EVHLPB01 | 46 | 1.5 | 4 | 4 |

EVPTTAU - EVOLVE CONNECTOR WITH U CHANNEL TOP TRIM ALUMINUM

- Aluminum top trim longer by 0.625" to cover width of connector with U channel. • Available in standard paint colors.
- Trim can not span a post.

| DESCRIPTION | PRODUCT CODE | LIST PRICE LP | DIMENSIONS/INCHES | | |
|--|--------------|------------------|-------------------|--------|---|
| | | | H | W | D |
|  Top Trim Aluminum | EVPTTAU24 | 25 | 1 | 24.625 | 1 |
| | EVPTTAU30 | 27 | 1 | 30.625 | 1 |
| | EVPTTAU36 | 30 | 1 | 36.625 | 1 |
| | EVPTTAU42 | 35 | 1 | 42.625 | 1 |
| | EVPTTAU48 | 48 | 1 | 48.625 | 1 |
| | EVPTTAU54 | 54 | 1 | 54.625 | 1 |
| | EVPTTAU60 | 59 | 1 | 60.625 | 1 |
| | EVPTTAU66 | 65 | 1 | 66.625 | 1 |
| | EVPTTAU72 | 73 | 1 | 72.625 | 1 |
| | EVPTTAU78 | 81 | 1 | 78.625 | 1 |
| EVPTTAU84 | 86 | 1 | 84.625 | 1 | |



EVLEP - 1" LAMINATE END PANEL

- 1" Laminate End Panel attaches to an end of run connector.
- Left Hand or Right Hand available.
- Finished in thermally Fused Laminate.
- Includes threaded metal inserts and support brackets to attach a worksurface on one side.
- 1" Laminate end panel have panel leveling glides.
- If wood grain is selected, grain runs vertically.

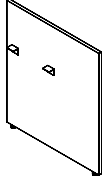
| | DESCRIPTION | PRODUCT CODE | LIST PRICE LP | DIMENSIONS/INCHES | | |
|---|--|--------------|------------------|-------------------|----|---|
| | | | | H | W | D |
|  | 1" Laminate End Panel - Right - 42" High | EVLEPR4224 | 376 | 42 | 24 | 1 |
| | | EVLEPR4230 | 470 | 42 | 30 | 1 |
| | | EVLEPR4236 | 563 | 42 | 36 | 1 |
| | | EVLEPR4242 | 656 | 42 | 42 | 1 |
| | | EVLEPR4248 | 750 | 42 | 48 | 1 |
| | 1" Laminate End Panel - Left - 42" High | EVLEPL4224 | 376 | 42 | 24 | 1 |
| | | EVLEPL4230 | 470 | 42 | 30 | 1 |
| | | EVLEPL4236 | 563 | 42 | 36 | 1 |
| | | EVLEPL4242 | 656 | 42 | 42 | 1 |
| | | EVLEPL4248 | 750 | 42 | 48 | 1 |
| | 1" Laminate End Panel - Right - 48" High | EVLEPR4824 | 424 | 48 | 24 | 1 |
| | | EVLEPR4830 | 537 | 48 | 30 | 1 |
| | | EVLEPR4836 | 644 | 48 | 36 | 1 |
| | | EVLEPR4842 | 747 | 48 | 42 | 1 |
| | | EVLEPR4848 | 857 | 48 | 48 | 1 |
| | 1" Laminate End Panel - Left - 48" High | EVLEPL4824 | 424 | 48 | 24 | 1 |
| | | EVLEPL4830 | 537 | 48 | 30 | 1 |
| | | EVLEPL4836 | 644 | 48 | 36 | 1 |
| | | EVLEPL4842 | 747 | 48 | 42 | 1 |
| | | EVLEPL4848 | 857 | 48 | 48 | 1 |

EVLMP - 1" LAMINATE MIDDLE PANEL

- 1" Laminate Middle Panel attaches to a double inline connector.
- Finished in thermally Fused Laminate.
- Includes threaded metal inserts and support brackets to attach worksurfaces on both sides.
- 1" Laminate middle panel has panel leveling glides.
- If wood grain is selected, grain runs vertically.

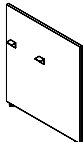
| | DESCRIPTION | PRODUCT CODE | LIST PRICE LP | DIMENSIONS/INCHES | | |
|---|-------------------------------------|--------------|------------------|-------------------|----|---|
| | | | | H | W | D |
|  | 1" Laminate Middle Panel - 42" High | EVLMP4224 | 420 | 42 | 24 | 1 |
| | | EVLMP4230 | 511 | 42 | 30 | 1 |
| | | EVLMP4236 | 605 | 42 | 36 | 1 |
| | | EVLMP4242 | 703 | 42 | 42 | 1 |
| | | EVLMP4248 | 845 | 42 | 48 | 1 |
| | 1" Laminate Middle Panel - 48" High | EVLMP4824 | 469 | 48 | 24 | 1 |
| | | EVLMP4830 | 578 | 48 | 30 | 1 |
| | | EVLMP4836 | 685 | 48 | 36 | 1 |
| | | EVLMP4842 | 794 | 48 | 42 | 1 |
| | | EVLMP4848 | 901 | 48 | 48 | 1 |

EVLEPXXYYA - 1" LAMINATE END PANEL WITH ACCESSORY RAIL

- 1" Laminate End Panel attaches to an end of run connector.
- Includes accessory rail.
- Accessories can be used on accessory rail. Please see accessory section for additional details.
- Finished in thermally Fused Laminate.
- Includes threaded metal inserts and support brackets to attach a worksurface on one side.
- 1" Laminate end panel have panel leveling glides.
- If wood grain is selected, grain runs vertically.

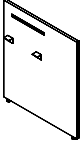
| | DESCRIPTION | PRODUCT CODE | LIST PRICE LP | DIMENSIONS/INCHES | | |
|---|---|--------------|------------------|-------------------|----|---|
| | | | | H | W | D |
|  | 1" Laminate End Panel with Accessory Rail - Right - 42" High | EVLEPR4224A | 425 | 42 | 24 | 1 |
| | | EVLEPR4230A | 517 | 42 | 30 | 1 |
| | | EVLEPR4236A | 613 | 42 | 36 | 1 |
| | | EVLEPR4242A | 710 | 42 | 42 | 1 |
| | | EVLEPR4248A | 808 | 42 | 48 | 1 |
| | 1" Laminate End Panel with Accessory Rail - Left - 42" High | EVLEPL4224A | 425 | 42 | 24 | 1 |
| | | EVLEPL4230A | 517 | 42 | 30 | 1 |
| | | EVLEPL4236A | 613 | 42 | 36 | 1 |
| | | EVLEPL4242A | 710 | 42 | 42 | 1 |
| | | EVLEPL4248A | 808 | 42 | 48 | 1 |
| 1" Laminate End Panel with Accessory Rail - Right - 48" High | EVLEPR4824A | 476 | 48 | 24 | 1 | |
| | EVLEPR4830A | 576 | 48 | 30 | 1 | |
| | EVLEPR4836A | 649 | 48 | 36 | 1 | |
| | EVLEPR4842A | 744 | 48 | 42 | 1 | |
| | EVLEPR4848A | 910 | 48 | 48 | 1 | |
| 1" Laminate End Panel with Accessory Rail - Left - 48" High | EVLEPL4824A | 476 | 48 | 24 | 1 | |
| | EVLEPL4830A | 576 | 48 | 30 | 1 | |
| | EVLEPL4836A | 649 | 48 | 36 | 1 | |
| | EVLEPL4842A | 744 | 48 | 42 | 1 | |
| | EVLEPL4848A | 910 | 48 | 48 | 1 | |

EVLMPXXYYA - 1" LAMINATE MIDDLE PANEL WITH ACCESSORY RAIL

- 1" Laminate Middle Panel attaches to a double inline connector.
- Includes accessory rail.
- Accessories can be used on accessory rail. Please see accessory section for additional details.
- Finished in thermally Fused Laminate.
- Includes threaded metal inserts and support brackets to attach a worksurface on one side.
- 1" Laminate middle panel has panel leveling glides.
- If wood grain is selected, grain runs vertically.

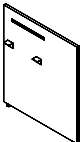
| | DESCRIPTION | PRODUCT CODE | LIST PRICE LP | DIMENSIONS/INCHES | | |
|---|--|--------------|------------------|-------------------|----|---|
| | | | | H | W | D |
|  | 1" Laminate Middle Panel with Accessory Rail - 42" High | EVLMP4224A | 479 | 42 | 24 | 1 |
| | | EVLMP4230A | 574 | 42 | 30 | 1 |
| | | EVLMP4236A | 674 | 42 | 36 | 1 |
| | | EVLMP4242A | 766 | 42 | 42 | 1 |
| | | EVLMP4248A | 865 | 42 | 48 | 1 |
| | 1" Laminate Middle Panel with Accessory Rail - 48" High | EVLMP4824A | 528 | 48 | 24 | 1 |
| | | EVLMP4830A | 644 | 48 | 30 | 1 |
| | | EVLMP4836A | 747 | 48 | 36 | 1 |
| | | EVLMP4842A | 857 | 48 | 42 | 1 |
| | | EVLMP4848A | 965 | 48 | 48 | 1 |



EVPDIC - DOUBLE INLINE PANEL CONNECTOR

- Used to connect 1" laminate middle panel to panels of equal height in a straight run.
- Aluminum top trim for double inline connector must be used.
- Provides slotted support for worksurfaces and hardware support.
- Includes two slotted posts with leveling glides and connection hardware.
- Use 17" flexible mesh jumper cable to pass-through panels.

| DESCRIPTION | PRODUCT CODE | LIST PRICE | DIMENSIONS/INCHES | | |
|-------------------------------|--------------|------------|-------------------|---|---|
| | | | H | W | D |
| Double Inline Panel Connector | EVPDIC42 | 168 | 42 | 2 | |
| | EVPDIC48 | 178 | 48 | 2 | |

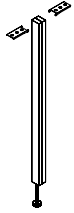

EVPBIC - BELTLINE DOUBLE INLINE PANEL CONNECTOR

- Used to connect 1" laminate middle panel to panels of equal height in a straight run.
- Use in-between beltline panels.
- Aluminum top trim for double inline connector must be used.
- Provides slotted support for worksurfaces and hardware support.
- Includes two slotted posts with leveling glides and connection hardware.
- Use 17" flexible mesh jumper cable to pass-through panels.

| DESCRIPTION | PRODUCT CODE | LIST PRICE | DIMENSIONS/INCHES | | |
|--|--------------|------------|-------------------|---|---|
| | | | H | W | D |
| Beltline Double Inline Panel Connector | EVPBIC42 | 168 | 42 | 2 | |
| | EVPBIC48 | 178 | 48 | 2 | |

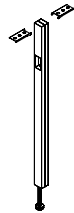

EVPDVTF - DOUBLE INLINE CONNECTOR TRIM

- Attaches to exposed side of double inline connector.

| | DESCRIPTION | PRODUCT CODE | LIST PRICE | DIMENSIONS/INCHES | | |
|---|------------------------------|--------------|------------|-------------------|---|---|
| | | | | H | W | D |
|  | Double Inline Connector Trim | EVPDVTF42 | 21 | 42 | | |
| | | EVPDVTF48 | 27 | 48 | | |

EVPTTA - DOUBLE INLINE PANEL CONNECTOR TOP TRIM - ALUMINUM

- Aluminum top trim is longer by 1.125" to cover width of panel and double inline connector.
- Trim cannot span a post connector.
- Available in standard and premium paint colors.

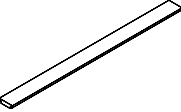
| | DESCRIPTION | PRODUCT CODE | LIST PRICE | DIMENSIONS/INCHES | | |
|--|---|--------------|------------|-------------------|---|---|
| | | | | H | W | D |
|  | Double Inline Connector Trim - Aluminum | EVPTTA25 | 25 | 25 | | |
| | | EVPTTA31 | 27 | 31 | | |
| | | EVPTTA37 | 21 | 37 | | |
| | | EVPTTA43 | 35 | 43 | | |
| | | EVPTTA49 | 48 | 49 | | |
| | | EVPTTA55 | 54 | 55 | | |
| | | EVPTTA61 | 59 | 61 | | |
| | | EVPTTA67 | 65 | 67 | | |
| | | EVPTTA73 | 73 | 73 | | |
| | | EVPTTA79 | 81 | 79 | | |
| | EVPTTA85 | 86 | 83 | | | |



EV PDS - DOOR PANEL - SOLID

- All door surfaces are high pressure laminate.
- HP Laminate finish available in all standard Evolve colors.
- Two panel widths: 36" or 42" High.
- 84" Door Panel height = 66"H panel plus one 18"H Panel Extension Module.
- 90" Door Panel height = 66" H panel plus one 24"H or two 12"H Panel Extension Modules.
- Door and door trim can be specified left- or right-handed (see diagram).
- Handedness of Door Panel can be changed in the field.
- Select door frame color from standard trim colors.
- Door Sizes:
 - 36"W Door is 33.63"W without frame (This door is not ADA compliant)
 - 42"W Door is 39.63"W without frame
 - 84"H Door is 81.5"H without frame
 - 90"H Door is 87.5"H without frame
- If laminate is selected in a wood grain, the grain runs vertical.
- Customer is responsible to confirm and meet all city, county or any other municipality codes in relation to door clearances.
- Knob or lever to be ordered separately

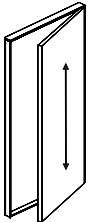
| | DESCRIPTION | PRODUCT CODE | LIST PRICE | | DIMENSIONS/INCHES | | |
|---|--|--------------|------------|--|-------------------|----|-------|
| | | | HPL | | H | W | D |
|  | Door Panel - Solid - 84" High x 36" Wide | EVPDS8436L | 2859 | | 84 | 36 | 2 7/8 |
| | | EVPDS8436R | 2859 | | 84 | 36 | 2 7/8 |
| | Door Panel - Solid - 84" High x 42" Wide | EVPDS8442L | 3309 | | 84 | 42 | 2 7/8 |
| | | EVPDS8442R | 3309 | | 84 | 42 | 2 7/8 |
| | Door Panel - Solid - 90" High x 36" Wide | EVPDS9036L | 2859 | | 90 | 36 | 2 7/8 |
| | | EVPDS9036R | 2859 | | 90 | 36 | 2 7/8 |
| | Door Panel - Solid - 90" High x 42" Wide | EVPDS9042L | 3309 | | 90 | 42 | 2 7/8 |
| | | EVPDS9042R | 3309 | | 90 | 42 | 2 7/8 |

EV PDG- FULL GLAZED DOOR PANEL

- All door surfaces are high pressure laminate with window.
- HP laminate finish available in all standard Evolve colors.
- Two panels width 36" or 42"
- 84" Door panel height = 66"H panel and 18" H Panel Extension Modules.
- 90" Door panel height = 66"H panel and 24" H or two 12" H Panel extension modules.
- Door and door trim can be specified left or right handed (see diagram).
- Handedness of Door can be changed in field.
- Select frame color from standard trim colors.
- Door Sizes:
 - 36"W Door is 33.63"W without frame (This door is not ADA compliant)
 - 42"W Door is 39.63"W without frame
 - 84"H Door is 81.5"H without frame
 - 90"H Door is 87.5"H without frame
- If laminate is selected in wood grain, the grain runs vertical.
- Customer is responsible to confirm and meet, city, county or any other municipality codes in relation to door clearances
- Knob or lever to be ordered separately

| | DESCRIPTION | PRODUCT CODE | PRICE | | DIMENSIONS/INCHES | | |
|---|---|--------------|-------|----------|-------------------|----|-------|
| | | | CLR | FRST ADD | H | W | D |
|  | Door Panel - Glazed - 84" High x 36" Wide | EVPDG8436L | 3212 | 128 | 84 | 36 | 2 7/8 |
| | | EVPDG8436R | 3212 | 128 | 84 | 36 | 2 7/8 |
| | Door Panel - Glazed - 84" High x 42" Wide | EVPDG8442L | 3661 | 129 | 84 | 42 | 2 7/8 |
| | | EVPDG8442R | 3661 | 129 | 84 | 42 | 2 7/8 |
| | Door Panel - Glazed - 90" High x 36" Wide | EVPDG9036L | 3212 | 128 | 90 | 36 | 2 7/8 |
| | | EVPDG9036R | 3212 | 128 | 90 | 36 | 2 7/8 |
| | Door Panel - Glazed - 90" High x 42" Wide | EVPDG9042L | 3661 | 129 | 90 | 42 | 2 7/8 |
| | | EVPDG9042R | 3661 | 129 | 90 | 42 | 2 7/8 |

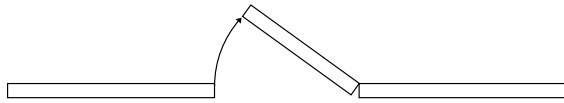

Right Hand Hung Door

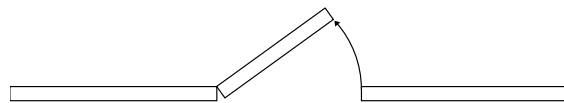

Left Hand Hung Door

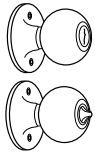

Knob Lock Set
(Knob Lock Set is not ADA compliant)
Lock set sold separately from doors.
Specific core #'s and Master Key not available

EVPSL01 119



Lever Lock Set
Lock set sold separately from doors.
Specific core #'s and Master Key not available

EVPSL02 163

EVHLPF01 - LOW PROFILE FOOT

- Used to provide additional support to panel run without adding panels
- Connects to inline connector or end of run at base of panels

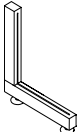
| DESCRIPTION | PRODUCT CODE | LIST PRICE | DIMENSIONS/INCHES | | |
|---|--------------|------------|-------------------|---|----|
| | | | H | W | D |
|  <p>Low Profile Foot</p> | EVHLPF01 | 129 | 11 | 1 | 11 |

EVPSL/R - SLIDING PRIVACY DOOR

- Sliding Privacy Door attaches to Evolve Panels using standard connectors to add privacy. Brackets that attach to Connectors are included.
- This door must mount on panels of equal width. It is also intended to be used for openings of equal width.
- Left (L) or right-handedness (R) is determined by the direction of door movement (from compressed to expanded position), while facing the door on the panel mounted side.
- Painted frame may match any Evolve Standard Paint Finish. The door interior is standard with a louvered acrylic finish.
- Telescoping arms eliminate the need for thresholds, wheels or casters.
- 81" H door must connect to panels 84" or higher.
- Thickness of louvered acrylic is 6 mm.

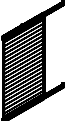
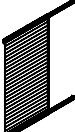
| DESCRIPTION | PRODUCT CODE | LIST PRICE | DIMENSIONS/INCHES | | |
|--|--------------|------------|-------------------|----|---|
| | | | H | W | D |
|  <p>Sliding Privacy Door - 66" High</p> | EVPSL6636R | 3217 | 66 | 36 | 3 |
| | EVPSL6636L | 3217 | 66 | 36 | 3 |
| | EVPSL6642R | 3300 | 66 | 42 | 3 |
| | EVPSL6642L | 3300 | 66 | 42 | 3 |
|  <p>Sliding Privacy Door - 81" High</p> | EVPSL8136R | 3397 | 81 | 36 | 3 |
| | EVPSL8136L | 3397 | 81 | 36 | 3 |
| | EVPSL8142R | 3647 | 81 | 42 | 3 |
| | EVPSL8142L | 3647 | 81 | 42 | 3 |



EVPSLLOCK - SLIDING DOOR LOCK

- Lock bracket attaches to sliding door with screws.
- Includes strike plate bracket which attaches to slots in connector.
- Lock included.
- Lock sets sold separately from sliding doors.
- Available in Tungsten only.

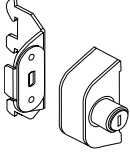
| | DESCRIPTION | PRODUCT CODE | LIST PRICE | DIMENSIONS/INCHES | | |
|---|---------------------------|--------------|------------|-------------------|-----|-----|
| | | | | H | W | D |
|  | Sliding Door Lock - Right | EVPSLLOCKR | 295 | 2.65 | 1.2 | 0.9 |
| | Sliding Door Lock - Left | EVPSLLOCKL | 295 | 2.65 | 1.2 | 0.9 |

EVMPK02 - MINI PANEL KIT

- Evolve's Mini Panel Kits are available to our dealers and their sales staff.
- All Mini Panel Kit orders receive standard freight terms (Free freight applies to orders dock delivered to one commercial business location in the contiguous United States during normal business hours. Residential deliveries will incur additional delivery charges.)
- The Evolve mini panel is an excellent sales tool featuring a cut away of a module and samples of various hardware and electrical components and consists of the following:
 - 1 EVFP3024 30 x 24 Premium with cut-away
 - 1 EVPCP232 Two-way corner post
 - 1 EVPER30 End of run trim kit
 - 1 EVDHPT24 High Profile Top Cap
 - 1 EVDCPHP2 Two-way High Profile Top Cap
 - 1 EVDPE4 Post Extension Lay in
 - 1 EVE8PD24 Power distribution housing
 - 1 EVE8CP16 Jumper Cable
 - 1 EVE8RDA/B Duplex Receptacle
 - 1 Pizza cutter spline tool
 - 1 Replacement fabric
 - 1 Panel Bag with Evolve Logo
 - 1 Parts Bag with Evolve Logo

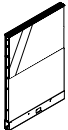
| | DESCRIPTION | PRODUCT CODE | LIST PRICE | DIMENSIONS/INCHES | | |
|---|----------------|--------------|------------|-------------------|----|-------|
| | | | | H | W | D |
|  | Mini Panel Kit | EVMPK02 | 2752 | 30 | 24 | 2 7/8 |

EVPRGLAXXY - ACOUSTIC GRID 5FT WIDE

- PET acoustic grid installed on top of panels
- Acoustic grid kit includes PET pieces, aluminum channel, hardware
- Panels configuration in back 30-30 , aluminum channel runs depth wise
- PET slats run from side to side
- PET pieces available in standard PET colors
- Separate PET colors available for outer skirt and inner structure
- Top trim with channel to be ordered separately
- Shipped KD , to be assembled on job site
- Additional sizes available up to 10' x 12'

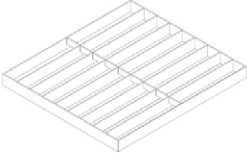
| DESCRIPTION | PRODUCT CODE | LIST PRICE | DIMENSIONS/INCHES | | |
|---|--------------|------------|-------------------|----|----|
| | | | H | W | D |
|  | EVPRGLA4860D | 2552 | 5.5 | 60 | 48 |
| | EVPRGLA6060D | 3024 | 5.5 | 60 | 60 |
| | EVPRGLA7260D | 3496 | 5.5 | 60 | 72 |
| | EVPRGLA8460D | 3968 | 5.5 | 60 | 84 |
| | EVPRGLA9060D | 4204 | 5.5 | 60 | 90 |
| | EVPRGLA9660D | 4475 | 5.5 | 60 | 96 |

EVPRGLAXXY - ACOUSTIC GRID 6FT WIDE

- PET acoustic grid installed on top of panels
- Acoustic grid kit includes PET pieces, aluminum channel, hardware
- Panels configuration in back 24-24-24 , aluminum channel runs depth wise
- PET slats run from side to side
- PET pieces available in standard PET colors
- Separate PET colors available for outer skirt and inner structure
- Top trim with channel to be ordered separately
- Shipped KD , to be assembled on job site
- Additional sizes available up to 10' x 12'

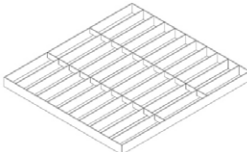
| DESCRIPTION | PRODUCT CODE | LIST PRICE | DIMENSIONS/INCHES | | |
|---|--------------|------------|-------------------|----|----|
| | | | H | W | D |
|  | EVPRGLA4872D | 3068 | 5.5 | 72 | 48 |
| | EVPRGLA6072D | 3641 | 5.5 | 72 | 60 |
| | EVPRGLA7272D | 4212 | 5.5 | 72 | 72 |
| | EVPRGLA8472D | 4783 | 5.5 | 72 | 84 |
| | EVPRGLA9072D | 5067 | 5.5 | 72 | 90 |
| | EVPRGLA9672D | 5388 | 5.5 | 72 | 96 |

EVPRGLAXXY - ACOUSTIC GRID 7FT WIDE

- PET acoustic grid installed on top of panels
- Acoustic grid kit includes PET pieces, aluminum channel, hardware
- Panels configuration in back 24-36-24 , aluminum channel runs depth wise
- PET slats run from side to side
- PET pieces available in standard PET colors
- Separate PET colors available for outer skirt and inner structure
- Top trim with channel to be ordered separately
- Shipped KD , to be assembled on job site
- Additional sizes available up to 10' x 12'

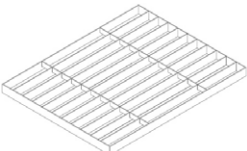
| DESCRIPTION | PRODUCT CODE | LIST PRICE | DIMENSIONS/INCHES | | |
|---|--------------|------------|-------------------|----|----|
| | | | H | W | D |
|  | EVPRGLA4884D | 3430 | 5.5 | 84 | 48 |
| | EVPRGLA6084D | 4061 | 5.5 | 84 | 60 |
| | EVPRGLA7284D | 4692 | 5.5 | 84 | 72 |
| | EVPRGLA8484D | 5323 | 5.5 | 84 | 84 |
| | EVPRGLA9084D | 5639 | 5.5 | 84 | 90 |
| | EVPRGLA9684D | 5989 | 5.5 | 84 | 96 |



EVPRGLAXXY - ACOUSTIC GRID 7-1/2 FT WIDE

- PET acoustic grid installed on top of panels
- Acoustic grid kit includes PET pieces, aluminum channel, hardware
- Panels configuration in back 30-30-30 , aluminum channel runs depth wise
- PET slats run from side to side
- PET pieces available in standard PET colors
- Separate PET colors available for outer skirt and inner structure
- Top trim with channel to be ordered separately
- Shipped KD, to be assembled on job site
- Additional sizes available up to 10' x 12'

| DESCRIPTION | PRODUCT CODE | LIST PRICE | DIMENSIONS/INCHES | | |
|---|--------------|------------|-------------------|----|----|
| | | | H | W | D |
|  | EVPRGLA4890D | 3562 | 5.5 | 90 | 48 |
| | EVPRGLA6090D | 4222 | 5.5 | 90 | 60 |
| | EVPRGLA7290D | 4883 | 5.5 | 90 | 72 |
| | EVPRGLA8490D | 5544 | 5.5 | 90 | 84 |
| | EVPRGLA9090D | 5876 | 5.5 | 90 | 90 |
| | EVPRGLA9690D | 6241 | 5.5 | 90 | 96 |

EVPRGLAXXY - ACOUSTIC GRID 8FT WIDE

- PET acoustic grid installed on top of panels
- Acoustic grid kit includes PET pieces, aluminum channel, hardware
- Panels configuration in back 30-36-30 , aluminum channel runs depth wise
- PET slats run from side to side
- PET pieces available in standard PET colors
- Separate PET colors available for outer skirt and inner structure
- Top trim with channel to be ordered separately
- Shipped KD, to be assembled on job site
- Additional sizes available up to 10' x 12'

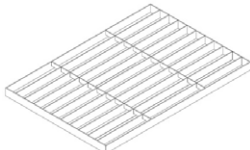
| DESCRIPTION | PRODUCT CODE | LIST PRICE | DIMENSIONS/INCHES | | |
|---|--------------|------------|-------------------|----|----|
| | | | H | W | D |
|  | EVPRGLA4896D | 3826 | 5.5 | 96 | 48 |
| | EVPRGLA6096D | 4517 | 5.5 | 96 | 60 |
| | EVPRGLA7296D | 5207 | 5.5 | 96 | 72 |
| | EVPRGLA8496D | 5899 | 5.5 | 96 | 84 |
| | EVPRGLA9096D | 6246 | 5.5 | 96 | 90 |
| | EVPRGLA9696D | 6625 | 5.5 | 96 | 96 |

EVPRGLAXXY - ACOUSTIC GRID 12FT WIDE

- PET acoustic grid installed on top of panels
- Acoustic grid kit includes PET pieces, aluminum channel, hardware
- Panels configuration in back 24-30--36-30-24 , aluminum channel runs depth wise
- PET slats run from side to side
- PET pieces available in standard PET colors
- Top trim with channel to be ordered separately
- Beam kit above opening for acoustic grid to be ordered separately
- Shipped KD, to be assembled on job site

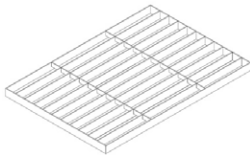
| DESCRIPTION | PRODUCT CODE | LIST PRICE | DIMENSIONS/INCHES | | |
|---|----------------|------------|-------------------|-----|-----|
| | | | H | W | D |
|  | EVPRGLA120144D | 8805 | 5.5 | 144 | 120 |

EVPTTCA - ALUMINUM TOP TRIM WITH CHANNEL

- Top trim with channel
- Available in standard paint colors
- Note: Trim can span inline connector, but not a Post

| DESCRIPTION | PRODUCT CODE | LIST PRICE | DIMENSIONS/INCHES | | |
|---|--------------|------------|-------------------|-------|---|
| | | | H | W | D |
|  | EVPTTCA18 | 18 | 18 | 2.875 | |
| | EVPTTCA24 | 26 | 24 | 2.875 | |
| | EVPTTCA30 | 33 | 30 | 2.875 | |
| | EVPTTCA36 | 36 | 36 | 2.875 | |
| | EVPTTCA42 | 43 | 42 | 2.875 | |
| | EVPTTCA48 | 53 | 48 | 2.875 | |
| | EVPTTCA54 | 62 | 54 | 2.875 | |
| | EVPTTCA60 | 69 | 60 | 2.875 | |
| | EVPTTCA66 | 75 | 66 | 2.875 | |
| | EVPTTCA72 | 84 | 72 | 2.875 | |
| | EVPTTCA78 | 91 | 78 | 2.875 | |
| | EVPTTCA84 | 101 | 84 | 2.875 | |
| | EVPTTCA90 | 107 | 90 | 2.875 | |
| | EVPTTCA96 | 116 | 96 | 2.875 | |



When ordering Panel Extension Modules, Inline Panel Extension Connectors (EVPIEC) must be ordered separately. Please see EVPIEC for details.

Inline Panel Extension Connectors connect two panel extension modules of equal height in a straight run.

Extension connectors do **not** provide support for hang-on storage components above 66" H.

When specifying stacking panels up to 66" H and using a single full height connector additional single clamps (EVCLVAR) are recommended. Order 2 clamps per extension module.

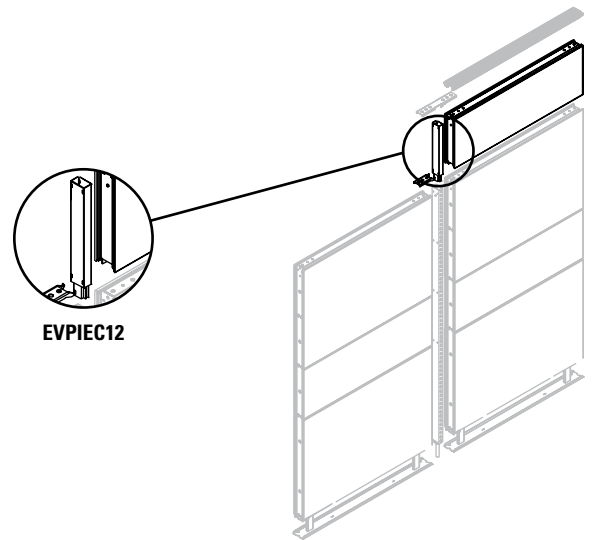
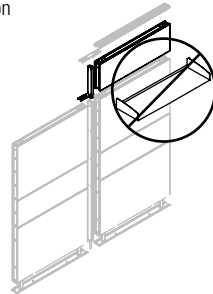

EVPIEC12

EXTENSION MODULES BY TYPE

Fabric Panel Extension Module

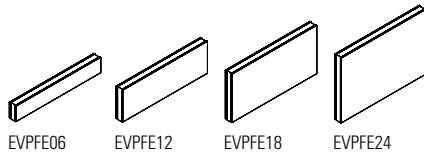

Fabric Panel Extension Module - Premium

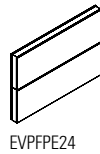

Tempered Glass Panel Extension Module

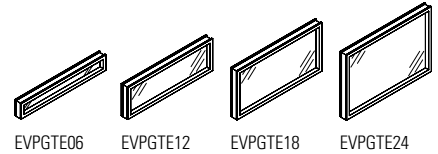

Tempered Glass Panel Extension Module - Premium

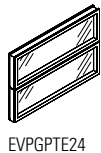

Write Board Extension Module - Single Sided

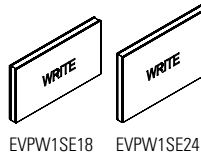

Write Board Extension Module - Double Sided

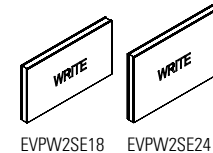

Laminate Extension Module - Single Sided

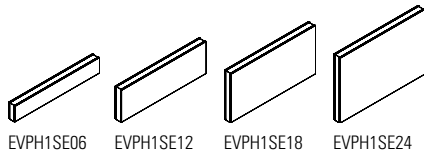

Laminate Extension Module - Double Sided

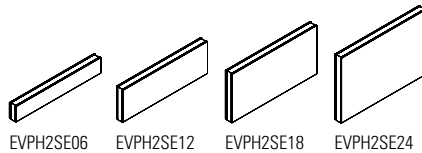

Air Flow Extension Module

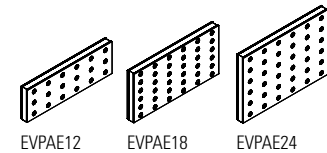

Open Panel Extension Module

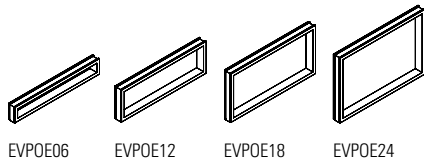

Panel Mount Privacy Glass

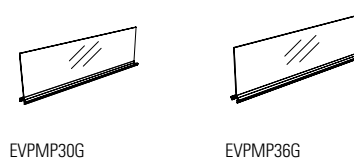

Panel Mount PET Felt Divider

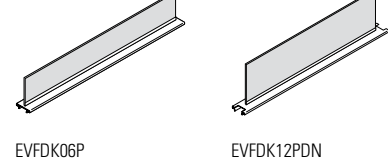

EVPFE - FABRIC PANEL EXTENSION MODULE

- Attaches on top of a panel.
- Modules can be stacked to add privacy or divide space.
- Panel Extension Modules are not load bearing if installed higher than 66" High.
- Each side of the fabric module may have a different fabric within the same grade at no charge.
- If different grades of fabric are used on one module, the entire module must be priced at highest grade.
- When ordering Panel Extension Modules, additional connectors are required.
- *Top Trims are not included with Extension Modules.

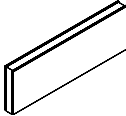
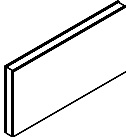
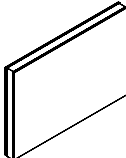
| | DESCRIPTION | PRODUCT CODE | LIST PRICE | | DIMENSIONS/INCHES | | |
|---|--|--------------|------------|-----|-------------------|----|-------|
| | | | Gr1 | Gr2 | H | W | D |
|  | Fabric Panel Extension Module - 6" High | EVPFE0618 | 185 | 193 | 6 | 18 | 2 7/8 |
| | | EVPFE0624 | 187 | 201 | 6 | 24 | 2 7/8 |
| | | EVPFE0630 | 205 | 221 | 6 | 30 | 2 7/8 |
| | | EVPFE0636 | 228 | 246 | 6 | 36 | 2 7/8 |
| | | EVPFE0642 | 258 | 273 | 6 | 42 | 2 7/8 |
| | | EVPFE0648 | 277 | 298 | 6 | 48 | 2 7/8 |
| | | EVPFE0654 | 299 | 320 | 6 | 54 | 2 7/8 |
| | | EVPFE0660 | 321 | 348 | 6 | 60 | 2 7/8 |
|  | Fabric Panel Extension Module - 12" High | EVPFE1218 | 185 | 193 | 12 | 18 | 2 7/8 |
| | | EVPFE1224 | 187 | 201 | 12 | 24 | 2 7/8 |
| | | EVPFE1230 | 205 | 221 | 12 | 30 | 2 7/8 |
| | | EVPFE1236 | 228 | 246 | 12 | 36 | 2 7/8 |
| | | EVPFE1242 | 258 | 273 | 12 | 42 | 2 7/8 |
| | | EVPFE1248 | 277 | 298 | 12 | 48 | 2 7/8 |
| | | EVPFE1254 | 299 | 320 | 12 | 54 | 2 7/8 |
| | | EVPFE1260 | 321 | 348 | 12 | 60 | 2 7/8 |
|  | Fabric Panel Extension Module - 18" High | EVPFE1818 | 223 | 239 | 18 | 18 | 2 7/8 |
| | | EVPFE1824 | 231 | 252 | 18 | 24 | 2 7/8 |
| | | EVPFE1830 | 251 | 277 | 18 | 30 | 2 7/8 |
| | | EVPFE1836 | 291 | 318 | 18 | 36 | 2 7/8 |
| | | EVPFE1842 | 319 | 354 | 18 | 42 | 2 7/8 |
| | | EVPFE1848 | 349 | 385 | 18 | 48 | 2 7/8 |
| | | EVPFE1854 | 378 | 419 | 18 | 54 | 2 7/8 |
| | | EVPFE1860 | 411 | 455 | 18 | 60 | 2 7/8 |
|  | Fabric Panel Extension Module - 24" High | EVPFE2418 | 223 | 239 | 24 | 18 | 2 7/8 |
| | | EVPFE2424 | 231 | 252 | 24 | 24 | 2 7/8 |
| | | EVPFE2430 | 251 | 277 | 24 | 30 | 2 7/8 |
| | | EVPFE2436 | 291 | 318 | 24 | 36 | 2 7/8 |
| | | EVPFE2442 | 319 | 354 | 24 | 42 | 2 7/8 |
| | | EVPFE2448 | 349 | 385 | 24 | 48 | 2 7/8 |
| | | EVPFE2454 | 378 | 419 | 24 | 54 | 2 7/8 |
| | | EVPFE2460 | 411 | 455 | 24 | 60 | 2 7/8 |

EVPFPE - FABRIC PANEL EXTENSION MODULE - PREMIUM

- Attaches on top of a panel.
- Modules can be stacked to add privacy or to divide space.
- Panel Extension Modules are not load bearing above 66" High.
- Each side of each module may have a different fabric within the same grade at no charge.
- If different grades of fabric are used on the Panel Extension Module, the module must be priced at highest grade.
- When ordering Panel Extension Modules, additional connectors are required.
- *Top Trims are not included with Extension Modules.

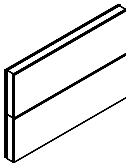
| | DESCRIPTION | PRODUCT CODE | LIST PRICE | | DIMENSIONS/INCHES | | |
|---|--|--------------|------------|-----|-------------------|----|-------|
| | | | Gr1 | Gr2 | H | W | D |
|  | Fabric Panel Extension Module - Premium - 24" High | EVPFPE2418 | 301 | 318 | 24 | 18 | 2 7/8 |
| | | EVPFPE2424 | 321 | 345 | 24 | 24 | 2 7/8 |
| | | EVPFPE2430 | 360 | 386 | 24 | 30 | 2 7/8 |
| | | EVPFPE2436 | 405 | 432 | 24 | 36 | 2 7/8 |
| | | EVPFPE2442 | 455 | 490 | 24 | 42 | 2 7/8 |
| | | EVPFPE2448 | 488 | 526 | 24 | 48 | 2 7/8 |
| | | EVPFPE2454 | 539 | 580 | 24 | 54 | 2 7/8 |
| | | EVPFPE2460 | 588 | 634 | 24 | 60 | 2 7/8 |



EVPGTE - TEMPERED GLASS PANEL EXTENSION MODULE

- Attaches on top of panel.
- Modules can be stacked to add privacy or to divide space.
- Panel Extension Modules are not load bearing above 66" H.
- Standard in clear (CLR) glass.
- Frosted Glass (FRST) 40% upcharge. Contact EVOLVE Customer Support for details.
- When ordering Panel Extension Modules, additional connectors are required.
- *Top Trims are not included with Extension Modules.

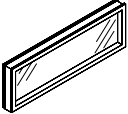
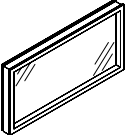
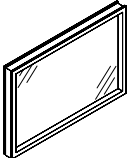
| | DESCRIPTION | PRODUCT CODE | LIST PRICE | DIMENSIONS/INCHES | | |
|---|--|--------------|------------|-------------------|----|-------|
| | | | | H | W | D |
|  | Tempered Glass Panel Extension Module - 6" High | EVPGTE0618 | 355 | 6 | 18 | 2 7/8 |
| | | EVPGTE0624 | 383 | 6 | 24 | 2 7/8 |
| | | EVPGTE0630 | 459 | 6 | 30 | 2 7/8 |
| | | EVPGTE0636 | 481 | 6 | 36 | 2 7/8 |
| | | EVPGTE0642 | 588 | 6 | 42 | 2 7/8 |
| | | EVPGTE0648 | 656 | 6 | 48 | 2 7/8 |
| | | EVPGTE0654 | 717 | 6 | 54 | 2 7/8 |
| EVPGTE0660 | 773 | 6 | 60 | 2 7/8 | | |
|  | Tempered Glass Panel Extension Module - 12" High | EVPGTE1218 | 355 | 12 | 18 | 2 7/8 |
| | | EVPGTE1224 | 383 | 12 | 24 | 2 7/8 |
| | | EVPGTE1230 | 459 | 12 | 30 | 2 7/8 |
| | | EVPGTE1236 | 481 | 12 | 36 | 2 7/8 |
| | | EVPGTE1242 | 588 | 12 | 42 | 2 7/8 |
| | | EVPGTE1248 | 656 | 12 | 48 | 2 7/8 |
| | | EVPGTE1254 | 717 | 12 | 54 | 2 7/8 |
| EVPGTE1260 | 773 | 12 | 60 | 2 7/8 | | |
|  | Tempered Glass Panel Extension Module - 18" High | EVPGTE1818 | 533 | 18 | 18 | 2 7/8 |
| | | EVPGTE1824 | 548 | 18 | 24 | 2 7/8 |
| | | EVPGTE1830 | 587 | 18 | 30 | 2 7/8 |
| | | EVPGTE1836 | 641 | 18 | 36 | 2 7/8 |
| | | EVPGTE1842 | 726 | 18 | 42 | 2 7/8 |
| | | EVPGTE1848 | 813 | 18 | 48 | 2 7/8 |
| | | EVPGTE1854 | 882 | 18 | 54 | 2 7/8 |
| EVPGTE1860 | 946 | 18 | 60 | 2 7/8 | | |
|  | Tempered Glass Panel Extension Module - 24" High | EVPGTE2418 | 533 | 24 | 18 | 2 7/8 |
| | | EVPGTE2424 | 548 | 24 | 24 | 2 7/8 |
| | | EVPGTE2430 | 587 | 24 | 30 | 2 7/8 |
| | | EVPGTE2436 | 641 | 24 | 36 | 2 7/8 |
| | | EVPGTE2442 | 726 | 24 | 42 | 2 7/8 |
| | | EVPGTE2448 | 813 | 24 | 48 | 2 7/8 |
| | | EVPGTE2454 | 882 | 24 | 54 | 2 7/8 |
| EVPGTE2460 | 946 | 24 | 60 | 2 7/8 | | |

EVPGPTE - TEMPERED GLASS PREMIUM PANEL EXTENSION MODULE

- Attaches to top of a panel.
- Modules can be stacked to add privacy or to divide space.
- Panel Extension Modules are not load bearing above 66" H.
- Standard in clear (CLR) glass.
- Frosted Glass (FRST) 40% upcharge. Contact EVOLVE Customer Support for details.
- When ordering Panel Extension Modules, additional connectors are required.
- *Top Trims are not included with Extension Modules.

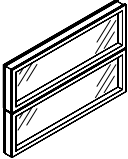
| | DESCRIPTION | PRODUCT CODE | LIST PRICE | DIMENSIONS/INCHES | | |
|---|--|--------------|------------|-------------------|----|-------|
| | | | | H | W | D |
|  | Tempered Glass Premium Panel Extension Module - 24" High | EVPGPTE2418 | 525 | 24 | 18 | 2 7/8 |
| | | EVPGPTE2424 | 582 | 24 | 24 | 2 7/8 |
| | | EVPGPTE2430 | 665 | 24 | 30 | 2 7/8 |
| | | EVPGPTE2436 | 757 | 24 | 36 | 2 7/8 |
| | | EVPGPTE2442 | 839 | 24 | 42 | 2 7/8 |
| | | EVPGPTE2448 | 941 | 24 | 48 | 2 7/8 |
| | | EVPGPTE2454 | 1026 | 24 | 54 | 2 7/8 |
| EVPGPTE2460 | 1111 | 224 | 60 | 2 7/8 | | |

EVPSG - PASS THRU SLIDING GLASS EXTENSION MODULE

- Pass thru with sliding glass door module.
- Attaches on top of a panel.
- Module can be stacked to add privacy or divide space.
- Panel extension module is not load bearing if installed higher than 66" High.
- When ordering panel extension modules , additional connectors are required.
- *Top Trims are not included with Extension Modules.

| | DESCRIPTION | PRODUCT CODE | PRICE | | DIMENSIONS/INCHES | | |
|---|--|--------------|-------|---------|-------------------|----|-------|
| | | | CLR | FRS ADD | H | W | D |
|  | Reception Panel Extension Module - 6" High | EVPSGE0636 | 384 | 80 | 6 | 36 | 2 7/8 |
| | | EVPSGE0642 | 411 | 86 | 6 | 42 | 2 7/8 |
| | | EVPSGE0648 | 500 | 101 | 6 | 48 | 2 7/8 |

EVPSG - PASS THRU SLIDING GLASS EXTENSION MODULE

- Pass thru with sliding glass door module.
- Attaches on top of a panel.
- Module can be stacked to add privacy or divide space.
- Panel extension module is not load bearing if installed higher than 66" High.
- When ordering panel extension modules , additional connectors are required.
- *Top Trims are not included with Extension Modules.

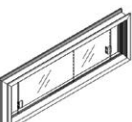
| | DESCRIPTION | PRODUCT CODE | PRICE | | DIMENSIONS/INCHES | | |
|---|---|--------------|-------|---------|-------------------|----|-------|
| | | | CLR | FRS ADD | H | W | D |
|  | Reception Panel Extension Module - 12" High | EVPSGE1236 | 465 | 95 | 12 | 36 | 2 7/8 |
| | | EVPSGE1242 | 492 | 101 | 12 | 42 | 2 7/8 |
| | | EVPSGE1248 | 515 | 107 | 12 | 48 | 2 7/8 |

EVPSGX - TALK THRU GLASS EXTENSION MODULE

- Talk thru glass module.
- Attaches on top of a panel.
- Module can be stacked to add privacy or divide space.
- Panel extension module is not load bearing if installed higher than 66" High.
- When ordering panel extension modules , additional connectors are required.
- *Top Trims are not included with Extension Modules.

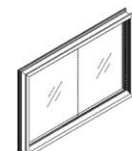
| | DESCRIPTION | PRODUCT CODE | PRICE | | DIMENSIONS/INCHES | | |
|---|---|--------------|-------|---------|-------------------|----|-------|
| | | | CLR | FRS ADD | H | W | D |
|  | Reception Panel Extension Module - 24" High | EVPSGXE2436 | 598 | 121 | 24 | 36 | 2 7/8 |
| | | EVPSGXE2442 | 658 | 131.6 | 24 | 42 | 2 7/8 |
| | | EVPSGXE2448 | 717 | 147 | 24 | 48 | 2 7/8 |

EVPSGX - TALK THRU GLASS EXTENSION MODULE

- Talk thru glass module.
- Attaches on top of a panel.
- Module can be stacked to add privacy or divide space.
- Panel extension module is not load bearing if installed higher than 66" High.
- When ordering panel extension modules , additional connectors are required.
- *Top Trims are not included with Extension Modules.

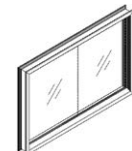
| | DESCRIPTION | PRODUCT CODE | PRICE | | DIMENSIONS/INCHES | | |
|---|---|--------------|-------|---------|-------------------|----|-------|
| | | | CLR | FRS ADD | H | W | D |
|  | Reception Panel Extension Module - 30" High | EVPSGXE3036 | 652 | 147 | 30 | 36 | 2 7/8 |
| | | EVPSGXE3042 | 733 | 149 | 30 | 42 | 2 7/8 |
| | | EVPSGXE3048 | 794 | 161 | 30 | 48 | 2 7/8 |



EVPW1SE - WRITE BOARD EXTENSION MODULE - SINGLE SIDED

- Attaches on top of a panel.
- Provides writing surface on a Single Side.
- Modules can be stacked to add privacy or to divide space.
- Panel Extension Modules are not load bearing above 66" H.
- When ordering Panel Extension Modules, additional connectors are required.
- High pressure only
- Use erasable Write Board markers only.
- *Top Trims are not included with Extension Modules.

| DESCRIPTION | PRODUCT CODE | LIST PRICE | | DIMENSIONS/INCHES | | |
|---|--------------|------------|-----|-------------------|-------|-------|
| | | Gr1 | Gr2 | H | W | D |
|  Write Board Extension Module - Single Sided 6"High | EVPW1SE0618 | 251 | 259 | 6 | 36 | 7/8 |
| | EVPW1SE0624 | 292 | 301 | 6 | 36 | 2 7/8 |
| | EVPW1SE0636 | 371 | 381 | 6 | 36 | 2 7/8 |
| | EVPW1SE0642 | 420 | 425 | 6 | 42 | 2 7/8 |
| | EVPW1SE0648 | 457 | 469 | 6 | 48 | 2 7/8 |
| | EVPW1SE0654 | 515 | 527 | 6 | 54 | 2 7/8 |
| | EVPW1SE0660 | 542 | 554 | 6 | 60 | 2 7/8 |
| Write Board Extension Module - Single Sided 12"High | EVPW1SE1218 | 251 | 259 | 12 | 36 | 2 7/8 |
| | EVPW1SE1224 | 292 | 301 | 12 | 36 | 2 7/8 |
| | EVPW1SE1236 | 371 | 381 | 12 | 36 | 2 7/8 |
| | EVPW1SE1242 | 420 | 425 | 12 | 42 | 2 7/8 |
| | EVPW1SE1248 | 457 | 469 | 12 | 48 | 2 7/8 |
| | EVPW1SE1254 | 515 | 527 | 12 | 54 | 2 7/8 |
| | EVPW1SE1260 | 542 | 554 | 12 | 60 | 2 7/8 |
| Write Board Extension Module - Single Sided 18"High | EVPW1SE1818 | 269 | 279 | 18 | 18 | 2 7/8 |
| | EVPW1SE1824 | 308 | 319 | 18 | 24 | 2 7/8 |
| | EVPW1SE1830 | 347 | 356 | 18 | 30 | 2 7/8 |
| | EVPW1SE1836 | 404 | 418 | 18 | 36 | 2 7/8 |
| | EVPW1SE1842 | 453 | 469 | 18 | 42 | 2 7/8 |
| | EVPW1SE1848 | 497 | 514 | 18 | 48 | 2 7/8 |
| | EVPW1SE1854 | 541 | 558 | 18 | 54 | 2 7/8 |
| EVPW1SE1860 | 582 | 602 | 18 | 60 | 2 7/8 | |
| Write Board Extension Module - Single Sided 24"High | EVPW1SE2418 | 269 | 279 | 24 | 18 | 2 7/8 |
| | EVPW1SE2424 | 308 | 321 | 24 | 24 | 2 7/8 |
| | EVPW1SE2430 | 347 | 360 | 24 | 30 | 2 7/8 |
| | EVPW1SE2436 | 404 | 419 | 24 | 36 | 2 7/8 |
| | EVPW1SE2442 | 453 | 471 | 24 | 42 | 2 7/8 |
| | EVPW1SE2448 | 497 | 516 | 24 | 48 | 2 7/8 |
| | EVPW1SE2454 | 541 | 558 | 24 | 54 | 2 7/8 |
| EVPW1SE2460 | 582 | 603 | 24 | 60 | 2 7/8 | |

EVPW2SE - WRITE BOARD EXTENSION MODULE - DOUBLE SIDED

- Attaches on top of a panel.
- Provides writing surface on two sides.
- Modules can be stacked to add privacy or to divide space.
- Panel Extension Modules are not load bearing above 66" H.
- When ordering Panel Extension Modules, additional connectors are required.
- High pressure only
- Use erasable Write Board markers only.
- *Top Trims are not included with Extension Modules.

| | DESCRIPTION | PRODUCT CODE | LIST PRICE | DIMENSIONS/INCHES | | | |
|---|---|--|-------------|-------------------|-------|-------|-------|
| | | | | H | W | D | |
|  | Write Board Extension Module - Double Sided - 6" High | EVPW2SE0618 | 270 | 6 | 18 | 2 7/8 | |
| | | EVPW2SE0624 | 319 | 6 | 24 | 2 7/8 | |
| | | EVPW2SE0630 | 368 | 6 | 30 | 2 7/8 | |
| | | EVPW2SE0636 | 422 | 6 | 36 | 2 7/8 | |
| | | EVPW2SE0642 | 479 | 6 | 42 | 2 7/8 | |
| | | EVPW2SE0648 | 534 | 6 | 48 | 2 7/8 | |
| | | EVPW2SE0654 | 616 | 6 | 54 | 2 7/8 | |
| | | EVPW2SE0660 | 632 | 6 | 60 | 2 7/8 | |
| | | Write Board Extension Module - Double Sided - 12" High | EVPW2SE1218 | 270 | 12 | 18 | 2 7/8 |
| | | | EVPW2SE1224 | 319 | 12 | 24 | 2 7/8 |
| EVPW2SE1230 | 368 | | 12 | 30 | 2 7/8 | | |
| EVPW2SE1236 | 422 | | 12 | 36 | 2 7/8 | | |
| EVPW2SE1242 | 479 | | 12 | 42 | 2 7/8 | | |
| EVPW2SE1248 | 534 | | 12 | 48 | 2 7/8 | | |
| EVPW2SE1254 | 616 | | 12 | 54 | 2 7/8 | | |
| EVPW2SE1260 | 632 | | 12 | 60 | 2 7/8 | | |
| Write Board Extension Module - Double Sided - 18" High | EVPW2SE1818 | 325 | 18 | 18 | 2 7/8 | | |
| | EVPW2SE1824 | 383 | 18 | 24 | 2 7/8 | | |
| | EVPW2SE1830 | 440 | 18 | 30 | 2 7/8 | | |
| | EVPW2SE1836 | 515 | 18 | 36 | 2 7/8 | | |
| | EVPW2SE1842 | 582 | 18 | 42 | 2 7/8 | | |
| | EVPW2SE1848 | 649 | 18 | 48 | 2 7/8 | | |
| | EVPW2SE1854 | 718 | 18 | 54 | 2 7/8 | | |
| | EVPW2SE1860 | 784 | 18 | 60 | 2 7/8 | | |
| Write Board Extension Module - Double Sided - 24" High | EVPW2SE2418 | 325 | 24 | 18 | 2 7/8 | | |
| | EVPW2SE2424 | 383 | 24 | 24 | 2 7/8 | | |
| | EVPW2SE2430 | 440 | 24 | 30 | 2 7/8 | | |
| | EVPW2SE2436 | 515 | 24 | 36 | 2 7/8 | | |
| | EVPW2SE2442 | 582 | 24 | 42 | 2 7/8 | | |
| | EVPW2SE2448 | 649 | 24 | 48 | 2 7/8 | | |
| | EVPW2SE2454 | 718 | 24 | 54 | 2 7/8 | | |
| | EVPW2SE2460 | 784 | 24 | 60 | 2 7/8 | | |



EVPH1SE - LAMINATE EXTENSION MODULE - SINGLE SIDED

- Attaches on top of a panel.
- Laminate face on the module provides a durable, washable surface on Single Side of the panel.
- Modules can be stacked to add privacy or to divide space.
- Panel Extension Modules are not load bearing above 66" H.
- When ordering Panel Extension Modules, additional connectors are required.
- Available in high pressure only.
- *Top Trims are not included with Extension Modules.

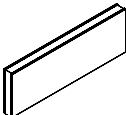
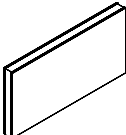
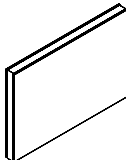
| | DESCRIPTION | PRODUCT CODE | LIST PRICE | | DIMENSIONS/INCHES | | |
|---|--|--------------|------------|-----|-------------------|----|-------|
| | | | Gr1 | Gr2 | H | W | D |
|  | Laminate Extension Module - Single Sided 6" High | EVPH1SE0618 | 251 | 259 | 6 | 18 | 2 7/8 |
| | | EVPH1SE0624 | 292 | 295 | 6 | 24 | 2 7/8 |
| | | EVPH1SE0630 | 327 | 329 | 6 | 30 | 2 7/8 |
| | | EVPH1SE0636 | 371 | 376 | 6 | 36 | 2 7/8 |
| | | EVPH1SE0642 | 420 | 422 | 6 | 42 | 2 7/8 |
| | | EVPH1SE0648 | 457 | 470 | 6 | 48 | 2 7/8 |
| | | EVPH1SE0654 | 515 | 527 | 6 | 54 | 2 7/8 |
| | | EVPH1SE0660 | 542 | 547 | 6 | 60 | 2 7/8 |
|  | Laminate Extension Module - Single Sided 12" High | EVPH1SE1218 | 251 | 259 | 12 | 18 | 2 7/8 |
| | | EVPH1SE1224 | 292 | 302 | 12 | 24 | 2 7/8 |
| | | EVPH1SE1230 | 327 | 334 | 12 | 30 | 2 7/8 |
| | | EVPH1SE1236 | 371 | 384 | 12 | 36 | 2 7/8 |
| | | EVPH1SE1242 | 420 | 429 | 12 | 42 | 2 7/8 |
| | | EVPH1SE1248 | 457 | 471 | 12 | 48 | 2 7/8 |
| | | EVPH1SE1254 | 515 | 529 | 12 | 54 | 2 7/8 |
| | | EVPH1SE1260 | 542 | 556 | 12 | 60 | 2 7/8 |
|  | Laminate Extension Module - Single Sided 18" High | EVPH1SE1818 | 335 | 344 | 18 | 18 | 2 7/8 |
| | | EVPH1SE1824 | 395 | 405 | 18 | 24 | 2 7/8 |
| | | EVPH1SE1830 | 455 | 469 | 18 | 30 | 2 7/8 |
| | | EVPH1SE1836 | 520 | 534 | 18 | 36 | 2 7/8 |
| | | EVPH1SE1842 | 587 | 601 | 18 | 42 | 2 7/8 |
| | | EVPH1SE1848 | 644 | 659 | 18 | 48 | 2 7/8 |
| | | EVPH1SE1854 | 697 | 717 | 18 | 54 | 2 7/8 |
| | | EVPH1SE1860 | 767 | 788 | 18 | 60 | 2 7/8 |
|  | Laminate Extension Module - Single Sided 24" High | EVPH1SE2418 | 335 | 348 | 24 | 18 | 2 7/8 |
| | | EVPH1SE2424 | 395 | 409 | 24 | 24 | 2 7/8 |
| | | EVPH1SE2430 | 455 | 471 | 24 | 30 | 2 7/8 |
| | | EVPH1SE2436 | 520 | 537 | 24 | 36 | 2 7/8 |
| | | EVPH1SE2442 | 587 | 604 | 24 | 42 | 2 7/8 |
| | | EVPH1SE2448 | 644 | 662 | 24 | 48 | 2 7/8 |
| | | EVPH1SE2454 | 697 | 721 | 24 | 54 | 2 7/8 |
| | | EVPH1SE2460 | 767 | 792 | 24 | 60 | 2 7/8 |

EVPH2SE - LAMINATE EXTENSION MODULE - DOUBLE SIDED

- Attaches on top of a panel.
- Laminate faces on both sides of the module provide durable, washable surfaces
- Modules can be stacked to add privacy or to divide space.
- Panel Extension Modules are not load bearing above 66" H
- When ordering Panel Extension Modules, additional connectors are required.
- Available in high pressure only.
- *Top Trims are not included with Extension Modules.

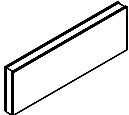
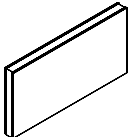
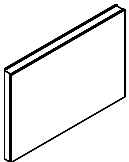
| | DESCRIPTION | PRODUCT CODE | LIST PRICE | DIMENSIONS/INCHES | | |
|---|--|--------------|------------|-------------------|----|-------|
| | | | | H | W | D |
|  | Laminate Extension Module - Double Sided 6" High | EVPH2SE0618 | 270 | 6 | 18 | 2 7/8 |
| | | EVPH2SE0624 | 319 | 6 | 24 | 2 7/8 |
| | | EVPH2SE0630 | 368 | 6 | 30 | 2 7/8 |
| | | EVPH2SE0636 | 422 | 6 | 36 | 2 7/8 |
| | | EVPH2SE0642 | 479 | 6 | 42 | 2 7/8 |
| | | EVPH2SE0648 | 534 | 6 | 48 | 2 7/8 |
| | | EVPH2SE0654 | 616 | 6 | 54 | 2 7/8 |
| | | EVPH2SE0660 | 646 | 6 | 60 | 2 7/8 |
|  | Laminate Extension Module - Double Sided 12" High | EVPH2SE1218 | 270 | 12 | 18 | 2 7/8 |
| | | EVPH2SE1224 | 319 | 12 | 24 | 2 7/8 |
| | | EVPH2SE1230 | 368 | 12 | 30 | 2 7/8 |
| | | EVPH2SE1236 | 422 | 12 | 36 | 2 7/8 |
| | | EVPH2SE1242 | 479 | 12 | 42 | 2 7/8 |
| | | EVPH2SE1248 | 534 | 12 | 48 | 2 7/8 |
| | | EVPH2SE1254 | 616 | 12 | 54 | 2 7/8 |
| | | EVPH2SE1260 | 632 | 12 | 60 | 2 7/8 |
|  | Laminate Extension Module - Double Sided 18" High | EVPH2SE1818 | 388 | 18 | 18 | 2 7/8 |
| | | EVPH2SE1824 | 469 | 18 | 24 | 2 7/8 |
| | | EVPH2SE1830 | 542 | 18 | 30 | 2 7/8 |
| | | EVPH2SE1836 | 629 | 18 | 36 | 2 7/8 |
| | | EVPH2SE1842 | 710 | 18 | 42 | 2 7/8 |
| | | EVPH2SE1848 | 805 | 18 | 48 | 2 7/8 |
| | | EVPH2SE1854 | 882 | 18 | 54 | 2 7/8 |
| | | EVPH2SE1860 | 950 | 18 | 60 | 2 7/8 |
|  | Laminate Extension Module - Double Sided 24" High | EVPH2SE2418 | 388 | 24 | 18 | 2 7/8 |
| | | EVPH2SE2424 | 469 | 24 | 24 | 2 7/8 |
| | | EVPH2SE2430 | 542 | 24 | 30 | 2 7/8 |
| | | EVPH2SE2436 | 629 | 24 | 36 | 2 7/8 |
| | | EVPH2SE2442 | 710 | 24 | 42 | 2 7/8 |
| | | EVPH2SE2448 | 805 | 24 | 48 | 2 7/8 |
| | | EVPH2SE2454 | 882 | 24 | 54 | 2 7/8 |
| | | EVPH2SE2460 | 950 | 24 | 60 | 2 7/8 |



EVPAE - AIR FLOW EXTENSION MODULE

- Metal air flow panel extension
- Attaches to top of panel
- Modules can be stacked to add privacy or to divide space.
- Panel Extension Modules are not load bearing above 66" H.
- When ordering Panel Extension Modules, additional connectors are required.
- *Top Trims are not included with Extension Modules.

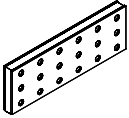
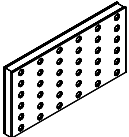
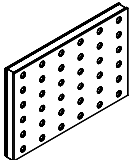
| | DESCRIPTION | PRODUCT CODE | LIST PRICE | DIMENSIONS/INCHES | | |
|---|--------------------------------------|--------------|------------|-------------------|----|-------|
| | | | | H | W | D |
|  | Air Flow Extension Module - 12" High | EVPAE1224 | 325 | 12 | 24 | 2 7/8 |
| | | EVPAE1230 | 388 | 12 | 30 | 2 7/8 |
| | | EVPAE1236 | 439 | 12 | 36 | 2 7/8 |
| | | EVPAE1242 | 484 | 12 | 42 | 2 7/8 |
| | | EVPAE1248 | 548 | 12 | 48 | 2 7/8 |
| | | EVPAE1254 | 633 | 18 | 54 | 2 7/8 |
| | | EVPAE1260 | 721 | 12 | 60 | 2 7/8 |
|  | Air Flow Extension Module - 18" High | EVPAE1824 | 409 | 18 | 24 | 2 7/8 |
| | | EVPAE1830 | 477 | 18 | 30 | 2 7/8 |
| | | EVPAE1836 | 528 | 18 | 36 | 2 7/8 |
| | | EVPAE1842 | 578 | 18 | 42 | 2 7/8 |
| | | EVPAE1848 | 665 | 18 | 48 | 2 7/8 |
| | | EVPAE1854 | 764 | 18 | 54 | 2 7/8 |
| | | EVPAE1860 | 858 | 18 | 60 | 2 7/8 |
|  | Air Flow Extension Module - 24" High | EVPAE2424 | 409 | 24 | 24 | 2 7/8 |
| | | EVPAE2430 | 477 | 24 | 30 | 2 7/8 |
| | | EVPAE2436 | 528 | 24 | 36 | 2 7/8 |
| | | EVPAE2442 | 578 | 24 | 42 | 2 7/8 |
| | | EVPAE2448 | 665 | 24 | 48 | 2 7/8 |
| | | EVPAE2454 | 757 | 18 | 54 | 2 7/8 |
| | | EVPAE2460 | 858 | 24 | 60 | 2 7/8 |

EVPOE - OPEN PANEL EXTENSION MODULE

- Attaches to top portion of a panel.
- Modules can be stacked to add privacy or to divide space
- Panel Extension Modules are not load bearing above 66" H.
- When ordering Panel Extension Modules, additional connectors are required.
- *Top Trims are not included with Extension Modules.

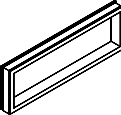
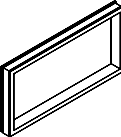
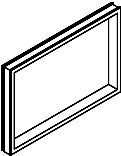
| | DESCRIPTION | PRODUCT CODE | LIST PRICE | DIMENSIONS/INCHES | | |
|---|--|--------------|------------|-------------------|----|-------|
| | | | | H | W | D |
|  | Open Panel Extension Module - 6" High | EVPOE0618 | 289 | 6 | 18 | 2 7/8 |
| | | EVPOE0624 | 295 | 6 | 24 | 2 7/8 |
| | | EVPOE0630 | 360 | 6 | 30 | 2 7/8 |
| | | EVPOE0636 | 376 | 6 | 36 | 2 7/8 |
| | | EVPOE0642 | 456 | 6 | 42 | 2 7/8 |
| | | EVPOE0648 | 512 | 6 | 48 | 2 7/8 |
| | | EVPOE0654 | 558 | 6 | 54 | 2 7/8 |
| | | EVPOE0660 | 602 | 6 | 60 | 2 7/8 |
|  | Open Panel Extension Module - 12" High | EVPOE1218 | 291 | 12 | 18 | 2 7/8 |
| | | EVPOE1224 | 297 | 12 | 24 | 2 7/8 |
| | | EVPOE1230 | 360 | 12 | 30 | 2 7/8 |
| | | EVPOE1236 | 376 | 12 | 36 | 2 7/8 |
| | | EVPOE1242 | 456 | 12 | 42 | 2 7/8 |
| | | EVPOE1248 | 513 | 12 | 48 | 2 7/8 |
| | | EVPOE1254 | 558 | 12 | 54 | 2 7/8 |
| | | EVPOE1260 | 604 | 12 | 60 | 2 7/8 |
|  | Open Panel Extension Module - 18" High | EVPOE1818 | 424 | 18 | 18 | 2 7/8 |
| | | EVPOE1824 | 431 | 18 | 24 | 2 7/8 |
| | | EVPOE1830 | 456 | 18 | 30 | 2 7/8 |
| | | EVPOE1836 | 499 | 18 | 36 | 2 7/8 |
| | | EVPOE1842 | 561 | 18 | 42 | 2 7/8 |
| | | EVPOE1848 | 633 | 18 | 48 | 2 7/8 |
| | | EVPOE1854 | 686 | 18 | 54 | 2 7/8 |
| | | EVPOE1860 | 739 | 18 | 60 | 2 7/8 |
|  | Open Panel Extension Module - 24" High | EVPOE2418 | 431 | 24 | 18 | 2 7/8 |
| | | EVPOE2424 | 424 | 24 | 24 | 2 7/8 |
| | | EVPOE2430 | 456 | 24 | 30 | 2 7/8 |
| | | EVPOE2436 | 499 | 24 | 36 | 2 7/8 |
| | | EVPOE2442 | 561 | 24 | 42 | 2 7/8 |
| | | EVPOE2448 | 633 | 24 | 48 | 2 7/8 |
| | | EVPOE2454 | 686 | 24 | 54 | 2 7/8 |
| | | EVPOE2460 | 739 | 24 | 60 | 2 7/8 |



EVPIECBS - BRIDGE PANEL INLINE EXTENSION CONNECTOR

- Connects bridge panel to inline extension connector.
- Includes one bridge extension connector and connecting hardware.

| | DESCRIPTION | PRODUCT CODE | LIST PRICE | DIMENSIONS/INCHES | | |
|---|---|--------------|------------|-------------------|---|---|
| | | | | H | W | D |
|  | Bridge Panel Inline Extension Connector | EVPIECBS06 | 49 | 6 | 3 | 3 |
| | | EVPIECBS12 | 49 | 12 | 3 | 3 |
| | | EVPIECBS18 | 58 | 18 | 3 | 3 |
| | | EVPIECBS24 | 58 | 24 | 3 | 3 |

EVPEERBSA - BRIDGE PANEL END OF RUN EXTENSION CONNECTOR - ALUMINUM TRIM

- Connects at end of run of bridge panel and can attach panel to fixed wall.
- Adds 1" to width of panel run.
- Provides slotted support for worksurfaces and hang on components up to 66"H.
- Includes one slotted bridge extension connector and connecting hardware and trim kit.

| | DESCRIPTION | PRODUCT CODE | LIST PRICE | DIMENSIONS/INCHES | | |
|--|---|--------------|------------|-------------------|---|---|
| | | | | H | W | D |
|  | Bridge Panel End of Run Extension Connector | EVPEERBSA06 | 53 | 6 | 3 | 3 |
| | Aluminum Trim | EVPEERBSA12 | 53 | 12 | 3 | 3 |
| | | EVPEERBSA18 | 64 | 18 | 3 | 3 |
| | | EVPEERBSA24 | 64 | 24 | 3 | 3 |

EVPICBS - BRIDGE PANEL INLINE CONNECTOR WITHOUT ALUMINUM INSERT

- Connects two bridge panels to inline connector.
- Inline connector in middle between two bridge panels, above opening, using double clamp at bottom.
- Includes one bridge extension connector without aluminum insert, includes connecting hardware.

| | DESCRIPTION | PRODUCT CODE | LIST PRICE | DIMENSIONS/INCHES | | |
|---|-------------------------------|--------------|------------|-------------------|---|---|
| | | | | H | W | D |
|  | Bridge Panel Inline Connector | EVPICBS06 | 49 | 6 | 3 | 3 |
| | without Aluminum Insert | EVPICBS12 | 49 | 12 | 3 | 3 |
| | | EVPICBS18 | 58 | 18 | 3 | 3 |
| | | EVPICBS24 | 58 | 24 | 3 | 3 |

EVPCEPB1 - BRIDGE PANEL CORNER EXTENSION POST 1 WAY

- Connects at end of a run of extension modules.
- Post and connecting hardware add 3.25" to power beam run.
- Includes one extension post, one slotted extension connectors for bridge panel, connecting hardware and trim kit.

| | DESCRIPTION | PRODUCT CODE | LIST PRICE | DIMENSIONS/INCHES | | |
|---|---|--------------|------------|-------------------|---|---|
| | | | | H | W | D |
|  | Bridge Panel Inline Extension Connector | EVPCEPBSA106 | 90 | 6 | 3 | 3 |
| | | EVPCEPBSA112 | 90 | 12 | 3 | 3 |
| | | EVPCEPBSA118 | 114 | 18 | 3 | 3 |
| | | EVPCEPBSA124 | 114 | 24 | 3 | 3 |

EVPCEPB2 - BRIDGE PANEL CORNER EXTENSION POST 2 WAY

- Connects two bridge panels in 90 degree configuration.
- Post and connecting hardware add 3.25" to power beam run.
- Includes one extension post, two one slotted extension connectors for bridge panel, connecting hardware and trim kit.

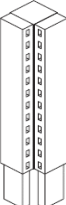
| | DESCRIPTION | PRODUCT CODE | LIST PRICE | DIMENSIONS/INCHES | | |
|---|--|--------------|------------|-------------------|---|---|
| | | | | H | W | D |
|  | Bridge Panel Corner Extension Post 2 way | EVPCEPBSA206 | 92 | 6 | 3 | 3 |
| | | EVPCEPBSA212 | 92 | 12 | 3 | 3 |
| | | EVPCEPBSA218 | 145 | 18 | 3 | 3 |
| | | EVPCEPBSA224 | 145 | 24 | 3 | 3 |

EVPCEPB3 - BRIDGE PANEL CORNER EXTENSION POST 3 WAY

- Connects three bridge panels in T degree configuration.
- Post and connecting hardware add 3.25" to power beam run.
- Includes one extension post, three one slotted extension connectors for bridge panel, connecting hardware and trim kit.

| | DESCRIPTION | PRODUCT CODE | LIST PRICE | DIMENSIONS/INCHES | | |
|---|--|--------------|------------|-------------------|---|---|
| | | | | H | W | D |
|  | Bridge Panel Corner Extension Post 3 way | EVPCEPBSA306 | 110 | 6 | 3 | 3 |
| | | EVPCEPBSA312 | 110 | 12 | 3 | 3 |
| | | EVPCEPBSA318 | 170 | 18 | 3 | 3 |
| | | EVPCEPBSA324 | 170 | 24 | 3 | 3 |



EVPCEPB4 - BRIDGE PANEL CORNER EXTENSION POST 4 WAY

- Connects four bridge panels in X degree configuration.
- Post and connecting hardware add 3.25" to power beam run.
- Includes one extension post, four one slotted extension connectors for bridge panel, connecting hardware and trim kit.

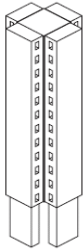

| DESCRIPTION | PRODUCT CODE | LIST PRICE | DIMENSIONS/INCHES | | |
|--|--------------|------------|-------------------|---|---|
| | | | H | W | D |
| Bridge Panel Corner Extension Post 4 way | EVPCEPBS406 | 127 | 6 | 3 | 3 |
| | EVPCEPBS412 | 127 | 12 | 3 | 3 |
| | EVPCEPBS418 | 187 | 18 | 3 | 3 |
| | EVPCEPBS424 | 187 | 24 | 3 | 3 |

EVPCEIPBSA2 - BRIDGE PANEL INLINE TWO WAY POST EXTENSION

- Connects two bridge panels in straight run.
- Post and connecting hardware add 3.25" to power beam run.
- Includes one extension post, two slotted extension connectors for bridge panel, connecting hardware and trim kit.



| DESCRIPTION | PRODUCT CODE | LIST PRICE | DIMENSIONS/INCHES | | |
|--|---------------|------------|-------------------|---|---|
| | | | H | W | D |
| Bridge Panel Inline Extension Post 2 way | EVPCEIPBSA206 | 97 | 6 | 3 | 3 |
| | EVPCEIPBSA212 | 97 | 12 | 3 | 3 |
| | EVPCEIPBSA218 | 158 | 18 | 3 | 3 |
| | EVPCEIPBSA224 | 158 | 24 | 3 | 3 |

EVPFEB - FABRIC PANEL BRIDGE MODULE

- Bridge modules connects two panels above opening.
- Requires bridge extension connectors, connects with clamps on top and at bottom.
- Each side of fabric module may have different fabric within the same grade at no charge.
- If different grades of fabric are used, the entire module must be price at highest grade.
- When ordering bridge modules , additional bridge connectors are required.
- Aluminum trim for bottom to be ordered separately.

| | DESCRIPTION | PRODUCT CODE | LIST PRICE | | DIMENSIONS/INCHES | | | |
|---|--------------------------------------|---------------------------------------|------------|-----|-------------------|----|----|---|
| | | | Gr1 | Gr2 | H | W | D | |
|  | Fabric Panel Bridge Module - 6" High | EVPFEB0618 | 185 | 193 | 6 | 18 | 3 | |
| | | EVPFEB0624 | 187 | 201 | 6 | 24 | 3 | |
| | | EVPFEB0630 | 205 | 221 | 6 | 30 | 3 | |
| | | EVPFEB0636 | 228 | 246 | 6 | 36 | 3 | |
| | | EVPFEB0642 | 258 | 273 | 6 | 42 | 3 | |
| | | EVPFEB0648 | 277 | 298 | 6 | 48 | 3 | |
| | | EVPFEB0654 | 299 | 320 | 6 | 54 | 3 | |
| | | EVPFEB0660 | 321 | 348 | 6 | 60 | 3 | |
| | | Fabric Panel Bridge Module - 12" High | EVPFEB1218 | 185 | 193 | 12 | 18 | 3 |
| | | | EVPFEB1224 | 187 | 201 | 12 | 24 | 3 |
| EVPFEB1230 | 205 | | 221 | 12 | 30 | 3 | | |
| EVPFEB1236 | 228 | | 246 | 12 | 36 | 3 | | |
| EVPFEB1242 | 258 | | 273 | 12 | 42 | 3 | | |
| EVPFEB1248 | 277 | | 298 | 12 | 48 | 3 | | |
| EVPFEB1254 | 299 | | 320 | 12 | 54 | 3 | | |
| EVPFEB1260 | 321 | | 348 | 12 | 60 | 3 | | |
| Fabric Panel Bridge Module - 18" High | EVPFEB1818 | 223 | 239 | 18 | 18 | 3 | | |
| | EVPFEB1824 | 231 | 252 | 18 | 24 | 3 | | |
| | EVPFEB1830 | 251 | 277 | 18 | 30 | 3 | | |
| | EVPFEB1836 | 291 | 318 | 18 | 36 | 3 | | |
| | EVPFEB1842 | 319 | 354 | 18 | 42 | 3 | | |
| | EVPFEB1848 | 349 | 385 | 18 | 48 | 3 | | |
| | EVPFEB1854 | 378 | 419 | 18 | 54 | 3 | | |
| | EVPFEB1860 | 411 | 455 | 18 | 60 | 3 | | |
| Fabric Panel Bridge Module - 24" High | EVPFEB2418 | 223 | 239 | 24 | 18 | 3 | | |
| | EVPFEB2424 | 231 | 252 | 24 | 24 | 3 | | |
| | EVPFEB2430 | 251 | 277 | 24 | 30 | 3 | | |
| | EVPFEB2436 | 291 | 318 | 24 | 36 | 3 | | |
| | EVPFEB2442 | 319 | 354 | 24 | 42 | 3 | | |
| | EVPFEB2448 | 349 | 385 | 24 | 48 | 3 | | |
| | EVPFEB2454 | 378 | 419 | 24 | 54 | 3 | | |
| | EVPFEB2460 | 411 | 455 | 24 | 60 | 3 | | |

EVPFPEB - FABRIC PANEL BRIDGE MODULE - PREMIUM

- Bridge modules connects two panels above opening.
- Requires bridge extension connectors, connects with clamps on top and at bottom.
- Each side of fabric module may have different fabric within the same grade at no charge.
- If different grades of fabric are used, the entire module must be price at highest grade.
- When ordering bridge modules , additional bridge connectors are required.
- Aluminum trim for bottom to be ordered separately.

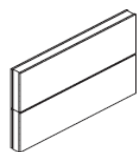
| | DESCRIPTION | PRODUCT CODE | LIST PRICE | | DIMENSIONS/INCHES | | |
|---|--------------------------------------|--------------|------------|-----|-------------------|----|---|
| | | | Gr1 | Gr2 | H | W | D |
|  | Fabric Panel Bridge Module - Premium | EVPFPEB2418 | 301 | 318 | 24 | 18 | 3 |
| | | EVPFPEB2424 | 321 | 345 | 24 | 24 | 3 |
| | | EVPFPEB2430 | 360 | 386 | 24 | 30 | 3 |
| | | EVPFPEB2436 | 405 | 432 | 24 | 36 | 3 |
| | | EVPFPEB2442 | 455 | 490 | 24 | 42 | 3 |
| | | EVPFPEB2448 | 488 | 526 | 24 | 48 | 3 |
| | | EVPFPEB2454 | 539 | 580 | 24 | 54 | 3 |
| | | EVPFPEB2460 | 588 | 634 | 24 | 60 | 3 |



EVPGTB - TEMPERED GLASS BRIDGE MODULE

- Bridge modules connects two panels above opening.
- Requires bridge extension connectors, connects with clamps on top and at bottom.
- Standard in clear (CLR) glass.
- Frosted glass (FRST) 40% upcharge. Contact Evolve Customer support for details.
- When ordering bridge modules, additional bridge connectors are required.
- Aluminum trim for bottom to be ordered separately.

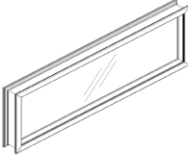
| | DESCRIPTION | PRODUCT CODE | LIST PRICE | DIMENSIONS/INCHES | | | |
|---|--|---|------------|-------------------|----|----|---|
| | | | | H | W | D | |
|  | Tempered Glass Bridge Module - 6" High | EVPGTB0618 | 355 | 6 | 18 | 3 | |
| | | EVPGTB0624 | 383 | 6 | 24 | 3 | |
| | | EVPGTB0630 | 459 | 6 | 30 | 3 | |
| | | EVPGTB0636 | 481 | 6 | 36 | 3 | |
| | | EVPGTB0642 | 588 | 6 | 42 | 3 | |
| | | EVPGTB0648 | 656 | 6 | 48 | 3 | |
| | | EVPGTB0654 | 717 | 6 | 54 | 3 | |
| | | EVPGTB0660 | 773 | 6 | 60 | 3 | |
| | | Tempered Glass Bridge Module - 12" High | EVPGTB1218 | 355 | 12 | 18 | 3 |
| | | | EVPGTB1224 | 383 | 12 | 24 | 3 |
| EVPGTB1230 | 459 | | 12 | 30 | 3 | | |
| EVPGTB1236 | 481 | | 12 | 36 | 3 | | |
| EVPGTB1242 | 588 | | 12 | 42 | 3 | | |
| EVPGTB1248 | 656 | | 12 | 48 | 3 | | |
| EVPGTB1254 | 717 | | 12 | 54 | 3 | | |
| EVPGTB1260 | 773 | | 12 | 60 | 3 | | |
| Tempered Glass Bridge Module - 18" High | EVPGTB1818 | 533 | 18 | 18 | 3 | | |
| | EVPGTB1824 | 548 | 18 | 24 | 3 | | |
| | EVPGTB1830 | 587 | 18 | 30 | 3 | | |
| | EVPGTB1836 | 641 | 18 | 36 | 3 | | |
| | EVPGTB1842 | 726 | 18 | 42 | 3 | | |
| | EVPGTB1848 | 813 | 18 | 48 | 3 | | |
| | EVPGTB1854 | 882 | 18 | 54 | 3 | | |
| | EVPGTB1860 | 946 | 18 | 60 | 3 | | |
| Tempered Glass Bridge Module - 24" High | EVPGTB2418 | 533 | 24 | 18 | 3 | | |
| | EVPGTB2424 | 548 | 24 | 24 | 3 | | |
| | EVPGTB2430 | 587 | 24 | 30 | 3 | | |
| | EVPGTB2436 | 641 | 24 | 36 | 3 | | |
| | EVPGTB2442 | 726 | 24 | 42 | 3 | | |
| | EVPGTB2448 | 813 | 24 | 48 | 3 | | |
| | EVPGTB2454 | 882 | 24 | 54 | 3 | | |
| | EVPGTB2460 | 946 | 24 | 60 | 3 | | |

EVPGTEB - TEMPERED GLASS BRIDGE MODULE - PREMIUM

- Bridge modules connects two panels above opening.
- Requires bridge extension connectors, connects with clamps at bottom.
- Standard in clear (CLR) glass.
- Frosted glass (FRST) 40% upcharge. Contact Evolve Customer support for details.
- When ordering bridge modules, additional bridge connectors are required.
- Aluminum trim for bottom to be ordered separately.

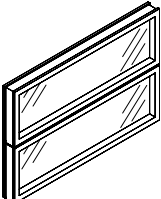
| | DESCRIPTION | PRODUCT CODE | LIST PRICE | DIMENSIONS/INCHES | | |
|---|--|--------------|------------|-------------------|----|---|
| | | | | H | W | D |
|  | Tempered Glass Bridge Module - Premium | EVPGTEB2418 | 525 | 24 | 18 | 3 |
| | | EVPGTEB2424 | 582 | 24 | 24 | 3 |
| | | EVPGTEB2430 | 665 | 24 | 30 | 3 |
| | | EVPGTEB2436 | 757 | 24 | 36 | 3 |
| | | EVPGTEB2442 | 839 | 24 | 42 | 3 |
| | | EVPGTEB2448 | 941 | 24 | 48 | 3 |
| | | EVPGTEB2454 | 1026 | 24 | 54 | 3 |
| | | EVPGTEB2460 | 1111 | 24 | 60 | 3 |

EVPW1SEB - WRITE BOARD BRIDGE MODULE - SINGLE SIDED

- Bridge modules connects two panels above opening.
- Requires bridge extension connectors, connects with clamps at bottom.
- Provides writing surface on Single side.
- Panel extension module is not load bearing if installed higher than 66" High.
- Use erasable Write Board markers only.
- When ordering bridge modules, additional bridge connectors are required.
- Aluminum trim for bottom to be ordered separately.

| DESCRIPTION | PRODUCT CODE | LIST PRICE | | DIMENSIONS/INCHES | | |
|--|--------------|------------|-----|-------------------|----|---|
| | | Gr1 | Gr2 | H | W | D |
|  Write Board Bridge Module - 6" High Single Sided | EVPW1SEB0618 | 251 | 259 | 6 | 18 | 3 |
| | EVPW1SEB0624 | 292 | 302 | 6 | 24 | 3 |
| | EVPW1SEB0630 | 327 | 334 | 6 | 30 | 3 |
| | EVPW1SEB0636 | 371 | 384 | 6 | 36 | 3 |
| | EVPW1SEB0642 | 420 | 429 | 6 | 42 | 3 |
| | EVPW1SEB0648 | 457 | 529 | 6 | 48 | 3 |
| | EVPW1SEB0654 | 515 | 529 | 6 | 54 | 3 |
| | EVPW1SEB0660 | 542 | 556 | 6 | 60 | 3 |
| Write Board Bridge Module - 12" High Single Sided | EVPW1SEB1218 | 251 | 259 | 12 | 18 | 3 |
| | EVPW1SEB1224 | 292 | 302 | 12 | 24 | 3 |
| | EVPW1SEB1230 | 327 | 334 | 12 | 30 | 3 |
| | EVPW1SEB1236 | 371 | 384 | 12 | 36 | 3 |
| | EVPW1SEB1242 | 420 | 429 | 12 | 42 | 3 |
| | EVPW1SEB1248 | 457 | 471 | 12 | 48 | 3 |
| | EVPW1SEB1254 | 515 | 529 | 12 | 54 | 3 |
| | EVPW1SEB1260 | 542 | 556 | 12 | 60 | 3 |
| Write Board Bridge Module - 18" High Single Sided | EVPW1SEB1818 | 335 | 348 | 18 | 18 | 3 |
| | EVPW1SEB1824 | 395 | 409 | 18 | 24 | 3 |
| | EVPW1SEB1830 | 455 | 471 | 18 | 30 | 3 |
| | EVPW1SEB1836 | 520 | 537 | 18 | 36 | 3 |
| | EVPW1SEB1842 | 587 | 604 | 18 | 42 | 3 |
| | EVPW1SEB1848 | 644 | 662 | 18 | 48 | 3 |
| | EVPW1SEB1854 | 697 | 721 | 18 | 54 | 3 |
| | EVPW1SEB1860 | 767 | 792 | 18 | 60 | 3 |
| Write Board Bridge Module - 24" High Single Sided | EVPW1SEB2418 | 335 | 348 | 24 | 18 | 3 |
| | EVPW1SEB2424 | 395 | 409 | 24 | 24 | 3 |
| | EVPW1SEB2430 | 455 | 471 | 24 | 30 | 3 |
| | EVPW1SEB2436 | 520 | 537 | 24 | 36 | 3 |
| | EVPW1SEB2442 | 587 | 604 | 24 | 42 | 3 |
| | EVPW1SEB2448 | 644 | 662 | 24 | 48 | 3 |
| | EVPW1SEB2454 | 697 | 721 | 24 | 54 | 3 |
| | EVPW1SEB2460 | 767 | 792 | 24 | 60 | 3 |



EVPW2SEB - WRITE BOARD BRIDGE MODULE - DOUBLE SIDED

- Bridge modules connects two panels above opening.
- Requires bridge extension connectors, connects with clamps at bottom.
- Provides writing surface on Single side.
- Panel extension module is not load bearing if installed higher than 66" High.
- Available in high pressure only.
- Use erasable Write Board markers only.
- When ordering bridge modules, additional bridge connectors are required.
- Aluminum trim for bottom to be ordered separately.

| DESCRIPTION | PRODUCT CODE | LIST PRICE | DIMENSIONS/INCHES | | |
|--|--------------|------------|-------------------|----|---|
| | | | H | W | D |
|  Write Board Bridge Module - 6" High Double Sided | EVPW2SEB0618 | 270 | 6 | 18 | 3 |
| | EVPW2SEB0624 | 319 | 6 | 24 | 3 |
| | EVPW2SEB0630 | 368 | 6 | 30 | 3 |
| | EVPW2SEB0636 | 422 | 6 | 36 | 3 |
| | EVPW2SEB0642 | 479 | 6 | 42 | 3 |
| | EVPW2SEB0648 | 534 | 6 | 48 | 3 |
| | EVPW2SEB0654 | 616 | 6 | 54 | 3 |
| | EVPW2SEB0660 | 632 | 6 | 60 | 3 |
| Tempered Glass Bridge Module - 12" High Double Sided | EVPW2SEB1218 | 270 | 12 | 18 | 3 |
| | EVPW2SEB1224 | 319 | 12 | 24 | 3 |
| | EVPW2SEB1230 | 368 | 12 | 30 | 3 |
| | EVPW2SEB1236 | 422 | 12 | 36 | 3 |
| | EVPW2SEB1242 | 479 | 12 | 42 | 3 |
| | EVPW2SEB1248 | 534 | 12 | 48 | 3 |
| | EVPW2SEB1254 | 616 | 12 | 54 | 3 |
| | EVPW2SEB1260 | 632 | 12 | 60 | 3 |
| Tempered Glass Bridge Module - 18" High Double Sided | EVPW2SEB1818 | 388 | 18 | 18 | 3 |
| | EVPW2SEB1824 | 469 | 18 | 24 | 3 |
| | EVPW2SEB1830 | 542 | 18 | 30 | 3 |
| | EVPW2SEB1836 | 629 | 18 | 36 | 3 |
| | EVPW2SEB1842 | 710 | 18 | 42 | 3 |
| | EVPW2SEB1848 | 805 | 18 | 48 | 3 |
| | EVPW2SEB1854 | 882 | 18 | 54 | 3 |
| | EVPW2SEB1860 | 950 | 18 | 60 | 3 |
| Tempered Glass Bridge Module - 24" High Double Sided | EVPW2SEB2418 | 388 | 24 | 18 | 3 |
| | EVPW2SEB2424 | 469 | 24 | 24 | 3 |
| | EVPW2SEB2430 | 542 | 24 | 30 | 3 |
| | EVPW2SEB2436 | 629 | 24 | 36 | 3 |
| | EVPW2SEB2442 | 710 | 24 | 42 | 3 |
| | EVPW2SEB2448 | 805 | 24 | 48 | 3 |
| | EVPW2SEB2454 | 882 | 24 | 54 | 3 |
| | EVPW2SEB2460 | 950 | 24 | 60 | 3 |

EVPH1SEB - LAMINATE BRIDGE MODULE - SINGLE SIDED

- Bridge modules connects two panels above opening.
- Requires bridge extension connectors, connects with clamps at bottom.
- Laminate face on module provides durable, washable surface on Single side of panel.
- Panel extension module is not load bearing if installed higher than 66" High.
- Available in high pressure only.
- When ordering bridge modules , additional bridge connectors are required.
- Aluminum trim for bottom to be ordered separately.

| DESCRIPTION | PRODUCT CODE | LIST PRICE | | DIMENSIONS/INCHES | | |
|---|--------------|------------|-----|-------------------|----|---|
| | | Gr1 | Gr2 | H | W | D |
|  Laminate Bridge Module - 6" High Single Sided | EVPH1SEB0618 | 251 | 259 | 6 | 18 | 3 |
| | EVPH1SEB0624 | 292 | 302 | 6 | 24 | 3 |
| | EVPH1SEB0630 | 327 | 334 | 6 | 30 | 3 |
| | EVPH1SEB0636 | 371 | 384 | 6 | 36 | 3 |
| | EVPH1SEB0642 | 420 | 429 | 6 | 42 | 3 |
| | EVPH1SEB0648 | 457 | 471 | 6 | 48 | 3 |
| | EVPH1SEB0654 | 515 | 529 | 6 | 54 | 3 |
| | EVPH1SEB0660 | 542 | 556 | 6 | 60 | 3 |
| Laminate Bridge Module - 12" High Single Sided | EVPH1SEB1218 | 251 | 259 | 12 | 18 | 3 |
| | EVPH1SEB1224 | 292 | 302 | 12 | 24 | 3 |
| | EVPH1SEB1230 | 327 | 334 | 12 | 30 | 3 |
| | EVPH1SEB1236 | 371 | 384 | 12 | 36 | 3 |
| | EVPH1SEB1242 | 420 | 429 | 12 | 42 | 3 |
| | EVPH1SEB1248 | 457 | 471 | 12 | 48 | 3 |
| | EVPH1SEB1254 | 515 | 529 | 12 | 54 | 3 |
| | EVPH1SEB1260 | 542 | 556 | 12 | 60 | 3 |
| Laminate Bridge Module - 18" High Single Sided | EVPH1SEB1818 | 335 | 348 | 18 | 18 | 3 |
| | EVPH1SEB1824 | 395 | 409 | 18 | 24 | 3 |
| | EVPH1SEB1830 | 455 | 471 | 18 | 30 | 3 |
| | EVPH1SEB1836 | 520 | 537 | 18 | 36 | 3 |
| | EVPH1SEB1842 | 587 | 604 | 18 | 42 | 3 |
| | EVPH1SEB1848 | 644 | 662 | 18 | 48 | 3 |
| | EVPH1SEB1854 | 697 | 721 | 18 | 54 | 3 |
| | EVPH1SEB1860 | 767 | 792 | 18 | 60 | 3 |
| Laminate Bridge Module - 24" High Single Sided | EVPH1SEB2418 | 335 | 348 | 24 | 18 | 3 |
| | EVPH1SEB2424 | 395 | 409 | 24 | 24 | 3 |
| | EVPH1SEB2430 | 455 | 471 | 24 | 30 | 3 |
| | EVPH1SEB2436 | 520 | 537 | 24 | 36 | 3 |
| | EVPH1SEB2442 | 587 | 604 | 24 | 42 | 3 |
| | EVPH1SEB2448 | 644 | 662 | 24 | 48 | 3 |
| | EVPH1SEB2454 | 697 | 721 | 24 | 54 | 3 |
| | EVPH1SEB2460 | 767 | 792 | 24 | 60 | 3 |



EVPH2SEB - LAMINATE BRIDGE MODULE - DOUBLE SIDED

- Bridge modules connects two panels above opening.
- Requires bridge extension connectors, connects with clamps at bottom.
- Laminate face on both sides of the module provides durable, washable surface.
- Panel extension module is not load bearing if installed higher than 66" High.
- When ordering panel extension modules, additional connectors are required.
- Available in high pressure only.
- When ordering bridge modules , additional bridge connectors are required.
- Aluminum trim for bottom to be ordered separately.

| | DESCRIPTION | PRODUCT CODE | LIST PRICE | DIMENSIONS/INCHES | | | |
|---|--|---|--------------|-------------------|----|----|---|
| | | | | H | W | D | |
|  | Laminate Bridge Module - 6" High Double Sided | EVPH2SEB0618 | 270 | 6 | 18 | 3 | |
| | | EVPH2SEB0624 | 319 | 6 | 24 | 3 | |
| | | EVPH2SEB0630 | 368 | 6 | 30 | 3 | |
| | | EVPH2SEB0636 | 422 | 6 | 36 | 3 | |
| | | EVPH2SEB0642 | 479 | 6 | 42 | 3 | |
| | | EVPH2SEB0648 | 534 | 6 | 48 | 3 | |
| | | EVPH2SEB0654 | 616 | 6 | 54 | 3 | |
| | | EVPH2SEB0660 | 632 | 6 | 60 | 3 | |
| | | Laminate Bridge Module - 12" High Double Sided | EVPH2SEB1218 | 270 | 12 | 18 | 3 |
| | | | EVPH2SEB1224 | 319 | 12 | 24 | 3 |
| EVPH2SEB1230 | 368 | | 12 | 30 | 3 | | |
| EVPH2SEB1236 | 422 | | 12 | 36 | 3 | | |
| EVPH2SEB1242 | 479 | | 12 | 42 | 3 | | |
| EVPH2SEB1248 | 534 | | 12 | 48 | 3 | | |
| EVPH2SEB1254 | 616 | | 12 | 54 | 3 | | |
| EVPH2SEB1260 | 632 | | 12 | 60 | 3 | | |
| Laminate Bridge Module - 18" High Double Sided | EVPH2SEB1818 | 388 | 18 | 18 | 3 | | |
| | EVPH2SEB1824 | 469 | 18 | 24 | 3 | | |
| | EVPH2SEB1830 | 542 | 18 | 30 | 3 | | |
| | EVPH2SEB1836 | 629 | 18 | 36 | 3 | | |
| | EVPH2SEB1842 | 710 | 18 | 42 | 3 | | |
| | EVPH2SEB1848 | 805 | 18 | 48 | 3 | | |
| | EVPH2SEB1854 | 882 | 18 | 54 | 3 | | |
| | EVPH2SEB1860 | 950 | 18 | 60 | 3 | | |
| Laminate Bridge Module - 24" High Double Sided | EVPH2SEB2418 | 388 | 24 | 18 | 3 | | |
| | EVPH2SEB2424 | 469 | 24 | 24 | 3 | | |
| | EVPH2SEB2430 | 542 | 24 | 30 | 3 | | |
| | EVPH2SEB2436 | 629 | 24 | 36 | 3 | | |
| | EVPH2SEB2442 | 710 | 24 | 42 | 3 | | |
| | EVPH2SEB2448 | 805 | 24 | 48 | 3 | | |
| | EVPH2SEB2454 | 882 | 24 | 54 | 3 | | |
| | EVPH2SEB2460 | 950 | 24 | 60 | 3 | | |

EVPMPXXGI6P - 6" H PANEL MOUNT PRIVACY GLASS W/ ALUMINUM TRIM

- Attaches on top of Evolve Panels to add privacy or divide space.
- Privacy Glass is integrated into the aluminum top trim.
- Aluminum trim must be specified for entire station when ordering panel mount privacy glass.
- Includes aluminum trim with channel and glass tile
- Glass and attachment hardware ship separately.
- Standard in clear (CLR) or frosted (FRST) glass.

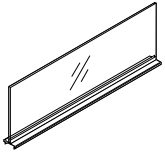
| | DESCRIPTION | PRODUCT CODE | LIST PRICE | | DIMENSIONS/INCHES | | |
|---|--|--------------|------------|---------|-------------------|-------|-------|
| | | | Clear | Frosted | H | W | D |
|  | 6" H Panel Mount Privacy Glass w/ Aluminum Trim - 24" Wide | EVPMP24GI6P | 281 | 68 | 6 | 24 | 2 7/8 |
| | 6" H Panel Mount Privacy Glass w/ Aluminum Trim - 30" Wide | EVPMP30GI6P | 304 | 49 | 6 | 30 | 2 7/8 |
| | 6" H Panel Mount Privacy Glass w/ Aluminum Trim - 36" Wide | EVPMP36GI6P | 335 | 35 | 6 | 36 | 2 7/8 |
| | 6" H Panel Mount Privacy Glass w/ Aluminum Trim - 42" Wide | EVPMP42GI6P | 350 | 58 | 6 | 42 | 2 7/8 |
| | 6" H Panel Mount Privacy Glass w/ Aluminum Trim - 48" Wide | EVPMP48GI6P | 359 | 74 | 6 | 48 | 2 7/8 |
| | 6" H Panel Mount Privacy Glass w/ Aluminum Trim - 54" Wide | EVPMP54GI6P | 372 | 93 | 6 | 54 | 2 7/8 |
| | 6" H Panel Mount Privacy Glass w/ Aluminum Trim - 60" Wide | EVPMP60GI6P | 383 | 123 | 6 | 60 | 2 7/8 |
| | 6" H Panel Mount Privacy Glass w/ Aluminum Trim - 66" Wide | EVPMP66GI6P | 443 | 147 | 6 | 66 | 2 7/8 |
| 6" H Panel Mount Privacy Glass w/ Aluminum Trim - 72" Wide | EVPMP72GI6P | 456 | 147 | 6 | 72 | 2 7/8 | |



EVMPMPXXGI9P - 9"H PANEL MOUNT PRIVACY GLASS W/ ALUMINUM TRIM

- Attaches on top of Evolve Panels to add privacy or divide space.
- Privacy Glass is integrated into the aluminum top trim.
- Aluminum trim must be specified for entire station when ordering panel mount privacy glass.
- Includes aluminum trim with channel and glass tile
- Glass and attachment hardware ship separately.
- Standard in clear (CLR) or frosted (FRST) glass.

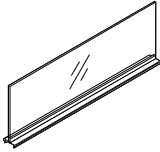
| | DESCRIPTION | PRODUCT CODE | LIST PRICE | | DIMENSIONS/INCHES | | |
|---|--|--------------|------------|---------|-------------------|-------|-------|
| | | | Clear | Frosted | H | W | D |
|  | 9" H Panel Mount Privacy Glass w/ Aluminum Trim - 24" Wide | EVMPMP24GI9P | 281 | 68 | 9 | 24 | 2 7/8 |
| | 9" H Panel Mount Privacy Glass w/ Aluminum Trim - 30" Wide | EVMPMP30GI9P | 304 | 49 | 9 | 30 | 2 7/8 |
| | 9" H Panel Mount Privacy Glass w/ Aluminum Trim - 36" Wide | EVMPMP36GI9P | 335 | 35 | 9 | 36 | 2 7/8 |
| | 9" H Panel Mount Privacy Glass w/ Aluminum Trim - 42" Wide | EVMPMP42GI9P | 350 | 58 | 9 | 42 | 2 7/8 |
| | 9" H Panel Mount Privacy Glass w/ Aluminum Trim - 48" Wide | EVMPMP48GI9P | 359 | 74 | 9 | 48 | 2 7/8 |
| | 9" H Panel Mount Privacy Glass w/ Aluminum Trim - 54" Wide | EVMPMP54GI9P | 372 | 93 | 9 | 54 | 2 7/8 |
| | 9" H Panel Mount Privacy Glass w/ Aluminum Trim - 60" Wide | EVMPMP60GI9P | 383 | 123 | 9 | 60 | 2 7/8 |
| | 9" H Panel Mount Privacy Glass w/ Aluminum Trim - 66" Wide | EVMPMP66GI9P | 443 | 147 | 9 | 66 | 2 7/8 |
| 9" H Panel Mount Privacy Glass w/ Aluminum Trim - 72" Wide | EVMPMP72GI9P | 456 | 147 | 9 | 72 | 2 7/8 | |

EVPMPXXGIP - 12" PANEL MOUNT PRIVACY GLASS W/ ALUMINUM TRIM

- Attaches on top of Evolve Panels to add privacy or divide space.
- Privacy Glass is integrated into the aluminum top trim.
- Includes aluminum trim with channel and glass tile.
- Standard in clear (CLR), frosted (FRST) or writeable (WRW) glass.

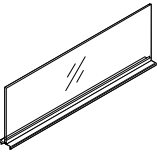
| | DESCRIPTION | PRODUCT CODE | LIST PRICE | | | DIMENSIONS/INCHES | | |
|---|---|--------------|------------|----------|---------|-------------------|-------|-------|
| | | | CLR | FRST ADD | WRW ADD | H | W | D |
|  | Panel Mount Privacy Glass w/ Aluminum Trim - 24" Wide | EVPMP24GIP | 290 | 68 | 183 | 12 | 24 | 2 7/8 |
| | Panel Mount Privacy Glass w/ Aluminum Trim - 30" Wide | EVPMP30GIP | 315 | 47 | 168 | 12 | 30 | 2 7/8 |
| | Panel Mount Privacy Glass w/ Aluminum Trim - 36" Wide | EVPMP36GIP | 335 | 35 | 159 | 12 | 36 | 2 7/8 |
| | Panel Mount Privacy Glass w/ Aluminum Trim - 42" Wide | EVPMP42GIP | 350 | 58 | 192 | 12 | 42 | 2 7/8 |
| | Panel Mount Privacy Glass w/ Aluminum Trim - 48" Wide | EVPMP48GIP | 369 | 74 | 224 | 12 | 48 | 2 7/8 |
| | Panel Mount Privacy Glass w/ Aluminum Trim - 54" Wide | EVPMP54GIP | 384 | 95 | 257 | 12 | 54 | 2 7/8 |
| | Panel Mount Privacy Glass w/ Aluminum Trim - 60" Wide | EVPMP60GIP | 395 | 123 | 295 | 12 | 60 | 2 7/8 |
| | Panel Mount Privacy Glass w/ Aluminum Trim - 66" Wide | EVPMP66GIP | 443 | 147 | 343 | 12 | 66 | 2 7/8 |
| Panel Mount Privacy Glass w/ Aluminum Trim - 72" Wide | EVPMP72GIP | 470 | 147 | 352 | 12 | 72 | 2 7/8 | |

EVPMPNXXGIP - 12" H PANEL MOUNT PRIVACY GLASS W/ NOTCHED TOP TRIM FOR INLINE VARIABLE HEIGHT CONNECTOR

- Privacy Glass integrated with aluminum top trim.
- Attaches on top of panels to add privacy or divide space.
- Includes aluminum top trim with channel with notched end and glass tile.
- Standard in clear (CLR) or frosted (FRST) glass.
- Aluminium trim must be specified for entire station when ordering panel mount privacy glass.
- Glass and attachment hardware to ship separately

| | DESCRIPTION | PRODUCT CODE | LIST PRICE | | DIMENSIONS/INCHES | | |
|---|--|--------------|------------|----------|-------------------|----|-------|
| | | | Clear | FRST ADD | H | W | D |
|  | Panel Mount Privacy Glass w/ Notched Top Trim for Variable Height Connector - 12" High | EVPMPN24GIP | 290 | 68 | 12 | 24 | 2 7/8 |
| | | EVPMPN30GIP | 315 | 49 | 12 | 30 | 2 7/8 |
| | | EVPMPN36GIP | 335 | 35 | 12 | 36 | 2 7/8 |
| | | EVPMPN42GIP | 350 | 58 | 12 | 42 | 2 7/8 |
| | | EVPMPN48GIP | 369 | 73.8 | 12 | 48 | 2 7/8 |
| | | EVPMPN54GIP | 384 | 93 | 12 | 54 | 2 7/8 |
| | | EVPMPN60GIP | 395 | 123 | 12 | 60 | 2 7/8 |



EVPMPDNXXGIP - 12" H PANEL MOUNT PRIVACY GLASS W/ DOUBLE NOTCHED TOP TRIM FOR INLINE VARIABLE HEIGHT CONNECTOR

- Privacy Glass integrated with aluminum top trim.
- Attaches on top of panels to add privacy or divide space.
- Includes aluminum top trim with channel with notched ends and glass tile.
- Standard in clear (CLR) or frosted (FRST) glass.
- Aluminium trim must be specified for entire station when ordering panel mount privacy glass.
- Glass and attachment hardware to ship separately.

| | DESCRIPTION | PRODUCT CODE | LIST PRICE | | DIMENSIONS/INCHES | | |
|---|---|--------------|------------|----------|-------------------|----|-------|
| | | | Clear | FRST ADD | H | W | D |
|  | Panel Mount Privacy Glass w/ double notched top trim for variable height connector - 12" High | EVPMPDN24GIP | 290 | 68 | 12 | 24 | 2 7/8 |
| | | EVPMPDN30GIP | 315 | 49 | 12 | 30 | 2 7/8 |
| | | EVPMPDN36GIP | 335 | 35 | 12 | 36 | 2 7/8 |
| | | EVPMPDN42GIP | 350 | 58 | 12 | 42 | 2 7/8 |
| | | EVPMPDN48GIP | 369 | 73.8 | 12 | 48 | 2 7/8 |
| | | EVPMPDN54GIP | 384 | 93 | 12 | 54 | 2 7/8 |
| | | EVPMPDN60GIP | 395 | 123 | 12 | 60 | 2 7/8 |

EVPMPXXGI18P - 18" H PANEL MOUNT PRIVACY GLASS

- Privacy Glass integrated with aluminum top trim.
- Attaches on top of panels to add privacy or divide space.
- Includes aluminum trim with channel and glass tile.
- Aluminium trim must be specified for entire station when ordering panel mount privacy glass.
- Glass and attachment hardware to ship separately.

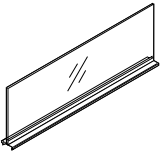
| | DESCRIPTION | PRODUCT CODE | LIST PRICE | | DIMENSIONS/INCHES | | |
|--|---|--------------|------------|----------|-------------------|----|-------|
| | | | Clear | FRST ADD | H | W | D |
|  | 18" H Panel Mount Privacy Glass w/ Aluminum Trim - 24" Wide | EVPMP24G118P | 433 | 97 | 18 | 24 | 2 7/8 |
| | 18" H Panel Mount Privacy Glass w/ Aluminum Trim - 30" Wide | EVPMP30G118P | 470 | 73 | 18 | 30 | 2 7/8 |
| | 18" H Panel Mount Privacy Glass w/ Aluminum Trim - 36" Wide | EVPMP36G118P | 501 | 50 | 18 | 36 | 2 7/8 |
| | 18" H Panel Mount Privacy Glass w/ Aluminum Trim - 42" Wide | EVPMP42G118P | 523 | 84 | 18 | 42 | 2 7/8 |
| | 18" H Panel Mount Privacy Glass w/ Aluminum Trim - 48" Wide | EVPMP48G118P | 554 | 109 | 18 | 48 | 2 7/8 |
| | 18" H Panel Mount Privacy Glass w/ Aluminum Trim - 54" Wide | EVPMP54G118P | 574 | 145 | 18 | 54 | 2 7/8 |
| | 18" H Panel Mount Privacy Glass w/ Aluminum Trim - 60" Wide | EVPMP60G118P | 593 | 182 | 18 | 60 | 2 7/8 |
| | 18" H Panel Mount Privacy Glass w/ Aluminum Trim - 66" Wide | EVPMP66G118P | 665 | 216 | 18 | 66 | 2 7/8 |
| | 18" H Panel Mount Privacy Glass w/ Aluminum Trim - 72" Wide | EVPMP72G118P | 703 | 217 | 18 | 72 | 2 7/8 |

EVPMPNXXG118P - 18" H PANEL MOUNT PRIVACY GLASS WITH NOTCHED TOP TRIM FOR VARIABLE HEIGHT CONNECTOR

- Privacy Glass integrated with aluminum top trim.
- Attaches on top of panels to add privacy or divide space.
- Includes aluminum trim with channel and glass tile.
- Standard in clear (CLR) or frosted (FRST) glass.
- Aluminium trim must be specified for entire station when ordering panel mount privacy glass.
- Glass and attachment hardware to ship separately.

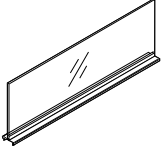
| | DESCRIPTION | PRODUCT CODE | LIST PRICE | | DIMENSIONS/INCHES | | |
|---|---|---------------|------------|----------|-------------------|-------|-------|
| | | | Clear | FRST ADD | H | W | D |
|  | 18" H Panel Mount Privacy Glass w/ Aluminum Trim - 24" Wide | EVPMPN24G118P | 433 | 97 | 18 | 24 | 2 7/8 |
| | 18" H Panel Mount Privacy Glass w/ Aluminum Trim - 30" Wide | EVPMPN30G118P | 470 | 73 | 18 | 30 | 2 7/8 |
| | 18" H Panel Mount Privacy Glass w/ Aluminum Trim - 36" Wide | EVPMPN36G118P | 501 | 50 | 18 | 36 | 2 7/8 |
| | 18" H Panel Mount Privacy Glass w/ Aluminum Trim - 42" Wide | EVPMPN42G118P | 523 | 84 | 18 | 42 | 2 7/8 |
| | 18" H Panel Mount Privacy Glass w/ Aluminum Trim - 48" Wide | EVPMPN48G118P | 554 | 109 | 18 | 48 | 2 7/8 |
| | 18" H Panel Mount Privacy Glass w/ Aluminum Trim - 54" Wide | EVPMPN54G118P | 574 | 145 | 18 | 54 | 2 7/8 |
| | 18" H Panel Mount Privacy Glass w/ Aluminum Trim - 60" Wide | EVPMPN60G118P | 593 | 182 | 18 | 60 | 2 7/8 |
| | 18" H Panel Mount Privacy Glass w/ Aluminum Trim - 66" Wide | EVPMPN66G118P | 665 | 216 | 18 | 66 | 2 7/8 |
| 18" H Panel Mount Privacy Glass w/ Aluminum Trim - 72" Wide | EVPMPN72G118P | 703 | 217 | 18 | 72 | 2 7/8 | |



EVPMPDNXXGI18P-18"H PANEL MOUNT PRIVACY GLASS WITH DOUBLE NOTCHED TOP TRIM FOR VARIABLE HEIGHT CONNECTOR

- Privacy Glass integrated with aluminum top trim.
- Attaches on top of panels to add privacy or divide space.
- Includes aluminum trim with channel and glass tile.
- Standard in clear (CLR) or frosted (FRST) glass.
- Aluminium trim must be specified for entire station when ordering panel mount privacy glass.
- Glass and attachment hardware to ship separately.

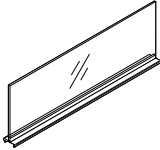
| | DESCRIPTION | PRODUCT CODE | LIST PRICE | | DIMENSIONS/INCHES | | |
|---|---|----------------|------------|----------|-------------------|-------|-------|
| | | | Clear | FRST ADD | H | W | D |
|  | 18" H Panel Mount Privacy Glass w/ Aluminum Trim - 24" Wide | EVPMPDN24GI18P | 433 | 97 | 18 | 24 | 2 7/8 |
| | 18" H Panel Mount Privacy Glass w/ Aluminum Trim - 30" Wide | EVPMPDN30GI18P | 470 | 73 | 18 | 30 | 2 7/8 |
| | 18" H Panel Mount Privacy Glass w/ Aluminum Trim - 36" Wide | EVPMPDN36GI18P | 501 | 50 | 18 | 36 | 2 7/8 |
| | 18" H Panel Mount Privacy Glass w/ Aluminum Trim - 42" Wide | EVPMPDN42GI18P | 523 | 84 | 18 | 42 | 2 7/8 |
| | 18" H Panel Mount Privacy Glass w/ Aluminum Trim - 48" Wide | EVPMPDN48GI18P | 554 | 109 | 18 | 48 | 2 7/8 |
| | 18" H Panel Mount Privacy Glass w/ Aluminum Trim - 54" Wide | EVPMPDN54GI18P | 574 | 145 | 18 | 54 | 2 7/8 |
| | 18" H Panel Mount Privacy Glass w/ Aluminum Trim - 60" Wide | EVPMPDN60GI18P | 593 | 182 | 18 | 60 | 2 7/8 |
| | 18" H Panel Mount Privacy Glass w/ Aluminum Trim - 66" Wide | EVPMPDN66GI18P | 665 | 216 | 18 | 66 | 2 7/8 |
| 18" H Panel Mount Privacy Glass w/ Aluminum Trim - 72" Wide | EVPMPDN72GI18P | 703 | 217 | 18 | 72 | 2 7/8 | |

EVPMPXXGI6PU - 6" H PANEL MOUNT PRIVACY GLASS FOR U CHANNEL FOR GALLERY PANEL ON ONE END

- Privacy Glass integrated with aluminum top trim to be used with U channel with connector for Gallery Panels.
- Attaches on top of panels to add privacy or divide space.
- Includes aluminum trim with channel and glass tile.
- Standard in clear (CLR) or frosted (FRST) glass.
- Aluminium trim must be specified for entire station when ordering panel mount privacy glass.
- Glass and attachment hardware to ship separately.
- Trim and glass extended for U channel from one end.

| DESCRIPTION | PRODUCT CODE | LIST PRICE | | DIMENSIONS/INCHES | | |
|--|--------------|------------|----------|-------------------|----|-----|
| | | Clear | FRST ADD | H | W | D |
|  6" H Panel Mount Privacy Glass U Channel for Gallery Panel | EVPMP24GI6PU | 324 | 48 | 6 | 24 | 5/8 |
| | EVPMP30GI6PU | 347 | 74 | 6 | 30 | 5/8 |
| | EVPMP36GI6PU | 360 | 418 | 6 | 36 | 5/8 |
| | EVPMP42GI6PU | 382 | 74 | 6 | 42 | 5/8 |
| | EVPMP48GI6PU | 395 | 97 | 6 | 48 | 5/8 |
| | EVPMP54GI6PU | 407 | 126 | 6 | 54 | 5/8 |
| | EVPMP60GI6PU | 443 | 146 | 6 | 60 | 5/8 |
| | EVPMP66GI6PU | 470 | 145 | 6 | 66 | 5/8 |
| | EVPMP72GI6PU | 497 | 142 | 6 | 72 | 5/8 |

EVPMPXXGI9PU - 9" H PANEL MOUNT PRIVACY GLASS FOR U CHANNEL FOR GALLERY PANEL ON ONE END

- Privacy Glass integrated with aluminum top trim to be used with U channel with connector for Gallery Panels.
- Attaches on top of panels to add privacy or divide space.
- Includes aluminum trim with channel and glass tile.
- Standard in clear (CLR) or frosted (FRST) glass.
- Aluminium trim must be specified for entire station when ordering panel mount privacy glass.
- Glass and attachment hardware to ship separately.
- Trim and glass extended for U channel from one end.

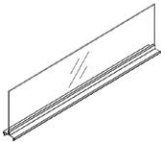
| DESCRIPTION | PRODUCT CODE | LIST PRICE | | DIMENSIONS/INCHES | | |
|--|--------------|------------|----------|-------------------|----|-----|
| | | Clear | FRST ADD | H | W | D |
|  9" H Panel Mount Privacy Glass U Channel for Gallery Panel | EVPMP24GI9PU | 324 | 48 | 9 | 24 | 5/8 |
| | EVPMP30GI9PU | 378 | 74 | 9 | 30 | 5/8 |
| | EVPMP36GI9PU | 416 | 418 | 9 | 36 | 5/8 |
| | EVPMP42GI9PU | 455 | 74 | 9 | 42 | 5/8 |
| | EVPMP48GI9PU | 492 | 97 | 9 | 48 | 5/8 |
| | EVPMP54GI9PU | 532 | 126 | 9 | 54 | 5/8 |
| | EVPMP60GI9PU | 443 | 146 | 9 | 60 | 5/8 |
| | EVPMP66GI9PU | 470 | 145 | 9 | 66 | 5/8 |
| | EVPMP72GI9PU | 497 | 142 | 9 | 72 | 5/8 |

EVPMPXXGI12PU - 12" H PANEL MOUNT PRIVACY GLASS FOR U CHANNEL FOR GALLERY PANEL ON ONE END

- Privacy Glass integrated with aluminum top trim to be used with U channel with connector for Gallery Panels.
- Attaches on top of panels to add privacy or divide space.
- Includes aluminum trim with channel and glass tile.
- Standard in clear (CLR) or frosted (FRST) glass.
- Aluminium trim must be specified for entire station when ordering panel mount privacy glass.
- Glass and attachment hardware to ship separately.
- Trim and glass extended for U channel from one end.

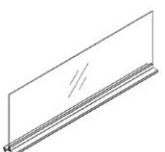
| DESCRIPTION | PRODUCT CODE | LIST PRICE | | DIMENSIONS/INCHES | | |
|---|---------------|------------|----------|-------------------|----|-----|
| | | Clear | FRST ADD | H | W | D |
|  12" H Panel Mount Privacy Glass U Channel for Gallery Panel | EVPMP24GI12PU | 324 | 48 | 12 | 24 | 5/8 |
| | EVPMP30GI12PU | 347 | 74 | 12 | 30 | 5/8 |
| | EVPMP36GI12PU | 360 | 418 | 12 | 36 | 5/8 |
| | EVPMP42GI12PU | 382 | 74 | 12 | 42 | 5/8 |
| | EVPMP48GI12PU | 395 | 97 | 12 | 48 | 5/8 |
| | EVPMP54GI12PU | 407 | 126 | 12 | 54 | 5/8 |
| | EVPMP60GI12PU | 443 | 146 | 12 | 60 | 5/8 |
| | EVPMP66GI12PU | 470 | 145 | 12 | 66 | 5/8 |
| | EVPMP72GI12PU | 497 | 142 | 12 | 72 | 5/8 |



EVPMPXXGI18PU - 18" H PANEL MOUNT PRIVACY GLASS FOR U CHANNEL FOR GALLERY PANEL ON ONE END

- Privacy Glass integrated with aluminum top trim to be used with U channel with connector for Gallery Panels.
- Attaches on top of panels to add privacy or divide space.
- Includes aluminum trim with channel and glass tile.
- Standard in clear (CLR) or frosted (FRST) glass.
- Aluminium trim must be specified for entire station when ordering panel mount privacy glass.
- Glass and attachment hardware to ship separately.
- Trim and glass extended for U channel from one end.

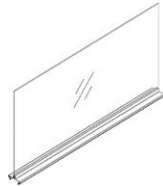

| DESCRIPTION | PRODUCT CODE | LIST PRICE | | DIMENSIONS/INCHES | | |
|--|---------------|------------|----------|-------------------|----|-----|
| | | Clear | FRST ADD | H | W | D |
| 18" H Panel Mount Privacy Glass U Channel for Gallery Panel | EVPMP24GI18PU | 470 | 71 | 18 | 24 | 5/8 |
| | EVPMP30GI18PU | 501 | 49 | 18 | 30 | 5/8 |
| | EVPMP36GI18PU | 523 | 572 | 18 | 36 | 5/8 |
| | EVPMP42GI18PU | 554 | 108 | 18 | 42 | 5/8 |
| | EVPMP48GI18PU | 574 | 141 | 18 | 48 | 5/8 |
| | EVPMP54GI18PU | 593 | 180 | 18 | 54 | 5/8 |
| | EVPMP60GI18PU | 665 | 213 | 18 | 60 | 5/8 |
| | EVPMP66GI18PU | 703 | 216 | 18 | 66 | 5/8 |
| | EVPMP72GI18PU | 743 | 217 | 18 | 72 | 5/8 |

EVPMPXXGI6PDU - 6" H PANEL MOUNT PRIVACY GLASS FOR U CHANNEL FOR GALLERY PANELS ON BOTH ENDS

- Privacy Glass integrated with aluminum top trim to be used with U channel with connector for Gallery Panels.
- Attaches on top of panels to add privacy or divide space.
- Includes aluminum trim with channel and glass tile.
- Standard in clear (CLR) or frosted (FRST) glass.
- Aluminium trim must be specified for entire station when ordering panel mount privacy glass.
- Glass and attachment hardware to ship separately.
- Trim and glass extended for U channel from both ends.



| DESCRIPTION | PRODUCT CODE | LIST PRICE | | DIMENSIONS/INCHES | | |
|---|---------------|------------|----------|-------------------|----|-----|
| | | Clear | FRST ADD | H | W | D |
| 6" H Panel Mount Privacy Glass U Channel for Gallery Panel | EVPMP24GI6PDU | 324 | 48 | 6 | 25 | 1/4 |
| | EVPMP30GI6PDU | 344 | 34.4 | 6 | 31 | 1/4 |
| | EVPMP36GI6PDU | 360 | 418 | 6 | 37 | 1/4 |
| | EVPMP42GI6PDU | 381 | 75 | 6 | 43 | 1/4 |
| | EVPMP48GI6PDU | 395 | 97 | 6 | 49 | 1/4 |
| | EVPMP54GI6PDU | 407 | 126 | 6 | 55 | 1/4 |
| | EVPMP60GI6PDU | 443 | 146 | 6 | 61 | 1/4 |
| | EVPMP66GI6PDU | 470 | 145 | 6 | 67 | 1/4 |
| | EVPMP72GI6PDU | 497 | 142 | 6 | 73 | 1/4 |

EVPMPXXGI9PDU - 9" H PANEL MOUNT PRIVACY GLASS FOR U CHANNEL FOR GALLERY PANELS ON BOTH ENDS

- Privacy Glass integrated with aluminum top trim to be used with U channel with connector for Gallery Panels.
- Attaches on top of panels to add privacy or divide space.
- Includes aluminum trim with channel and glass tile.
- Standard in clear (CLR) or frosted (FRST) glass.
- Aluminium trim must be specified for entire station when ordering panel mount privacy glass.
- Glass and attachment hardware to ship separately.
- Trim and glass extended for U channel from both ends.

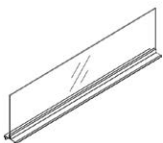

| DESCRIPTION | PRODUCT CODE | LIST PRICE | | DIMENSIONS/INCHES | | |
|---|---------------|------------|----------|-------------------|----|-----|
| | | Clear | FRST ADD | H | W | D |
| 9" H Panel Mount Privacy Glass U Channel for Gallery Panel | EVPMP24GI9PDU | 324 | 48 | 9 | 25 | 1/4 |
| | EVPMP30GI9PDU | 344 | 34.4 | 9 | 31 | 1/4 |
| | EVPMP36GI9PDU | 360 | 418 | 9 | 37 | 1/4 |
| | EVPMP42GI9PDU | 381 | 75 | 9 | 43 | 1/4 |
| | EVPMP48GI9PDU | 395 | 97 | 9 | 49 | 1/4 |
| | EVPMP54GI9PDU | 407 | 126 | 9 | 55 | 1/4 |
| | EVPMP60GI9PDU | 443 | 146 | 9 | 61 | 1/4 |
| | EVPMP66GI9PDU | 470 | 145 | 9 | 67 | 1/4 |
| | EVPMP72GI9PDU | 497 | 142 | 9 | 73 | 1/4 |

EVPMPXXGIPDU - 12" H PANEL MOUNT PRIVACY GLASS FOR U CHANNEL FOR GALLERY PANELS ON BOTH ENDS

- Privacy Glass integrated with aluminum top trim to be used with U channel with connector for Gallery Panels.
- Attaches on top of panels to add privacy or divide space.
- Includes aluminum trim with channel and glass tile.
- Standard in clear (CLR) or frosted (FRST) glass.
- Aluminium trim must be specified for entire station when ordering panel mount privacy glass.
- Glass and attachment hardware to ship separately.
- Trim and glass extended for U channel from both ends.

| DESCRIPTION | PRODUCT CODE | LIST PRICE | | DIMENSIONS/INCHES | | |
|--|--------------|------------|----------|-------------------|--------|---|
| | | Clear | FRST ADD | H | W | D |
|  <p>12" H Panel Mount Privacy Glass U Channel for Gallery Panel</p> | EVPMP24GIPDU | 324 | 48 | 12 | 25 1/4 | |
| | EVPMP30GIPDU | 344 | 34.4 | 12 | 31 1/4 | |
| | EVPMP36GIPDU | 360 | 418 | 12 | 37 1/4 | |
| | EVPMP42GIPDU | 381 | 75 | 12 | 43 1/4 | |
| | EVPMP48GIPDU | 395 | 97 | 12 | 49 1/4 | |
| | EVPMP54GIPDU | 407 | 126 | 12 | 55 1/4 | |
| | EVPMP60GIPDU | 443 | 146 | 12 | 61 1/4 | |
| | EVPMP66GIPDU | 470 | 145 | 12 | 67 1/4 | |
| | EVPMP72GIPDU | 497 | 142 | 12 | 73 1/4 | |

EVPMPXXGI18PDU - 18" H PANEL MOUNT PRIVACY GLASS FOR U CHANNEL FOR GALLERY PANELS ON BOTH ENDS

- Privacy Glass integrated with aluminum top trim to be used with U channel with connector for Gallery Panels.
- Attaches on top of panels to add privacy or divide space.
- Includes aluminum trim with channel and glass tile.
- Standard in clear (CLR) or frosted (FRST) glass.
- Aluminium trim must be specified for entire station when ordering panel mount privacy glass.
- Glass and attachment hardware to ship separately.
- Trim and glass extended for U channel from both ends.

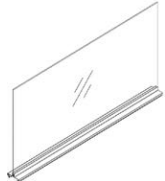
| DESCRIPTION | PRODUCT CODE | LIST PRICE | | DIMENSIONS/INCHES | | |
|--|----------------|------------|----------|-------------------|--------|---|
| | | Clear | FRST ADD | H | W | D |
|  <p>18" H Panel Mount Privacy Glass U Channel for Gallery Panel</p> | EVPMP24GI18PDU | 471 | 69 | 18 | 25 1/4 | |
| | EVPMP30GI18PDU | 501 | 49 | 18 | 31 1/4 | |
| | EVPMP36GI18PDU | 522 | 607 | 18 | 37 1/4 | |
| | EVPMP42GI18PDU | 554 | 108 | 18 | 43 1/4 | |
| | EVPMP48GI18PDU | 574 | 141 | 18 | 49 1/4 | |
| | EVPMP54GI18PDU | 593 | 180 | 18 | 55 1/4 | |
| | EVPMP60GI18PDU | 664 | 216 | 18 | 61 1/4 | |
| | EVPMP66GI18PDU | 704 | 213 | 18 | 67 1/4 | |
| | EVPMP72GI18PDU | 743 | 74 | 18 | 73 1/4 | |



EVMPMPXXGI6W - 6" H PRIVACY GLASS W/ ALUMINUM TRIM FOR 1" LAMINATE PANEL

- Attaches on top of Evolve 1" Laminate Panels to add privacy or divide space.
- Privacy Glass is integrated into the aluminum top trim.
- Aluminum trim has rail for accessories.
- Includes aluminum trim with end caps and glass tile
- Glass and attachment hardware ship separately.
- Standard in clear (CLR) or frosted (FRST) glass.

| | DESCRIPTION | PRODUCT CODE | LIST PRICE | | DIMENSIONS/INCHES | | |
|---|--|--------------|------------|----------|-------------------|----|---|
| | | | Clear | FRST ADD | H | W | D |
|  | 6" H Privacy Glass w/ Aluminum Trim for 1" Laminate Panel - 24" Wide | EVMPMP24GI6W | 290 | 68 | 6 | 24 | 1 |
| | 6" H Privacy Glass w/ Aluminum Trim for 1" Laminate Panel- 30" Wide | EVMPMP30GI6W | 315 | 49 | 6 | 30 | 1 |
| | 6" H Privacy Glass w/ Aluminum Trim for 1" Laminate Panel - 36" Wide | EVMPMP36GI6W | 335 | 35 | 6 | 36 | 1 |
| | 6" H Privacy Glass w/ Aluminum Trim for 1" Laminate Panel- 42" Wide | EVMPMP42GI6W | 350 | 58 | 6 | 42 | 1 |
| | 6" H Privacy Glass w/ Aluminum Trim for 1" Laminate Panel- 48" Wide | EVMPMP48GI6W | 369 | 73.8 | 6 | 48 | 1 |

EVMPMPXXGI9W - 9" H PRIVACY GLASS W/ ALUMINUM TRIM FOR 1" LAMINATE PANEL

- Attaches on top of Evolve 1" Laminate Panels to add privacy or divide space.
- Privacy Glass is integrated into the aluminum top trim.
- Aluminum trim has rail for accessories.
- Includes aluminum trim with end caps and glass tile
- Glass and attachment hardware ship separately.
- Standard in clear (CLR) or frosted (FRST) glass.

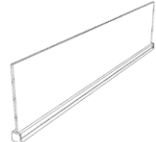
| | DESCRIPTION | PRODUCT CODE | LIST PRICE | | DIMENSIONS/INCHES | | |
|---|--|--------------|------------|----------|-------------------|----|---|
| | | | Clear | FRST ADD | H | W | D |
|  | 9" H Privacy Glass w/ Aluminum Trim for 1" Laminate Panel - 24" Wide | EVMPMP24GI9W | 290 | 68 | 9 | 24 | 1 |
| | 9" H Privacy Glass w/ Aluminum Trim for 1" Laminate Panel- 30" Wide | EVMPMP30GI9W | 315 | 49 | 9 | 30 | 1 |
| | 9" H Privacy Glass w/ Aluminum Trim for 1" Laminate Panel - 36" Wide | EVMPMP36GI9W | 335 | 35 | 9 | 36 | 1 |
| | 9" H Privacy Glass w/ Aluminum Trim for 1" Laminate Panel- 42" Wide | EVMPMP42GI9W | 350 | 58 | 9 | 42 | 1 |
| | 9" H Privacy Glass w/ Aluminum Trim for 1" Laminate Panel- 48" Wide | EVMPMP48GI9W | 369 | 73.8 | 9 | 48 | 1 |

EVPMPXXGIW - 12" H PRIVACY GLASS W/ ALUMINUM TRIM FOR 1" LAMINATE PANEL

- Attaches on top of Evolve 1" Laminate Panels to add privacy or divide space.
- Privacy Glass is integrated into the aluminum top trim.
- Aluminum trim has rail for accessories.
- Includes aluminum trim with end caps and glass tile
- Glass and attachment hardware ship separately.
- Standard in clear (CLR), frosted (FRST) or writeable (WRW) glass.

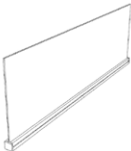
| | DESCRIPTION | PRODUCT CODE | LIST PRICE | | | DIMENSIONS/INCHES | | |
|---|---|--------------|------------|----------|---------|-------------------|----|---|
| | | | CLR | FRST ADD | WRW ADD | H | W | D |
|  | 12" H Privacy Glass w/ Aluminum Trim for 1" Laminate Panel - 24" Wide | EVPMP24GIW | 290 | 68 | 183 | 12 | 24 | 1 |
| | 12" H Privacy Glass w/ Aluminum Trim for 1" Laminate Panel - 30" Wide | EVPMP30GIW | 315 | 49 | 168 | 12 | 30 | 1 |
| | 12" H Privacy Glass w/ Aluminum Trim for 1" Laminate Panel - 36" Wide | EVPMP36GIW | 335 | 35 | 158 | 12 | 36 | 1 |
| | 12" H Privacy Glass w/ Aluminum Trim for 1" Laminate Panel - 42" Wide | EVPMP42GIW | 350 | 58 | 192 | 12 | 42 | 1 |
| | 12" H Privacy Glass w/ Aluminum Trim for 1" Laminate Panel - 48" Wide | EVPMP48GIW | 369 | 74 | 223 | 12 | 48 | 1 |

EVFPDW - 6" H FELT DIVIDER W/ ALUMINUM TRIM FOR 1" LAMINATE PANEL

- Privacy Felt Divider integrated with aluminum top trim.
- Attaches on top of laminate panels to add privacy or divide space.
- Includes aluminum trim with channel and felt tile.
- Felt and attachment hardware to ship separately.
- 9 mm felt material is tackable and comes in 9 different colors. Please specify color.
- Aluminum top trim available in standard paint finishes.

| | DESCRIPTION | PRODUCT CODE | LIST PRICE | DIMENSIONS/INCHES | | |
|---|--|--------------|------------|-------------------|----|---|
| | | | | H | W | D |
|  | 6" H Felt Divider w/ Aluminum Trim for 1" Laminate Panel | EVFPD0624W | 116 | 6 | 24 | 1 |
| | | EVFPD0630W | 135 | 6 | 30 | 1 |
| | | EVFPD0636W | 160 | 6 | 36 | 1 |
| | | EVFPD0642W | 180 | 6 | 42 | 1 |
| | | EVFPD0648W | 264 | 6 | 48 | 1 |
| | | EVFPD0654W | 289 | 6 | 54 | 1 |
| | | EVFPD0660W | 310 | 6 | 60 | 1 |
| | | EVFPD0666W | 327 | 6 | 66 | 1 |
| | | EVFPD0672W | 369 | 6 | 72 | 1 |

EVFPDW - 9" H FELT DIVIDER W/ ALUMINUM TRIM FOR 1" LAMINATE PANEL

- Privacy Felt Divider integrated with aluminum top trim.
- Attaches on top of laminate panels to add privacy or divide space.
- Includes aluminum trim with channel and felt tile.
- Felt and attachment hardware to ship separately.
- 9 mm felt material is tackable and comes in 9 different colors. Please specify color.
- Aluminum top trim available in standard paint finishes.

| | DESCRIPTION | PRODUCT CODE | LIST PRICE | DIMENSIONS/INCHES | | |
|---|--|--------------|------------|-------------------|----|---|
| | | | | H | W | D |
|  | 9" H Felt Divider w/ Aluminum Trim for 1" Laminate Panel | EVFPD0924W | 116 | 9 | 24 | 1 |
| | | EVFPD0930W | 135 | 9 | 30 | 1 |
| | | EVFPD0936W | 160 | 9 | 36 | 1 |
| | | EVFPD0942W | 180 | 9 | 42 | 1 |
| | | EVFPD0948W | 264 | 9 | 48 | 1 |
| | | EVFPD0954W | 289 | 9 | 54 | 1 |
| | | EVFPD0960W | 310 | 9 | 60 | 1 |
| | | EVFPD0966W | 327 | 9 | 66 | 1 |
| | | EVFPD0972W | 369 | 9 | 72 | 1 |



EVFPDW - 12" H FELT DIVIDER W/ ALUMINUM TRIM FOR 1" LAMINATE PANEL

- Privacy Felt Divider integrated with aluminum top trim.
- Attaches on top of laminate panels to add privacy or divide space.
- Includes aluminum trim with channel and felt tile.
- Felt and attachment hardware to ship separately.
- 9 mm felt material is tackable and is available in standard PET colors. Please specify.
- Aluminum top trim available in standard paint finishes.

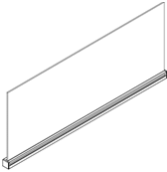
| DESCRIPTION | PRODUCT CODE | LIST PRICE | DIMENSIONS/INCHES | | |
|--|--------------|------------|-------------------|----|---|
| | | | H | W | D |
|  <p>12" H Felt Divider w/ Aluminum Trim for 1" Laminate Panel</p> | EVFPD1224W | 116 | 12 | 24 | 1 |
| | EVFPD1230W | 135 | 12 | 30 | 1 |
| | EVFPD1236W | 160 | 12 | 36 | 1 |
| | EVFPD1242W | 180 | 12 | 42 | 1 |
| | EVFPD1248W | 264 | 12 | 48 | 1 |
| | EVFPD1254W | 289 | 12 | 54 | 1 |
| | EVFPD1260W | 310 | 12 | 60 | 1 |
| | EVFPD1266W | 327 | 12 | 66 | 1 |
| | EVFPD1272W | 369 | 12 | 72 | 1 |

EVFPDW - 18" H FELT DIVIDER W/ ALUMINUM TRIM FOR 1" LAMINATE PANEL

- Privacy Felt Divider integrated with aluminum top trim.
- Attaches on top of laminate panels to add privacy or divide space.
- Includes aluminum trim with channel and felt tile.
- Felt and attachment hardware to ship separately.
- 9 mm felt material is tackable and is available in standard PET colors. Please specify..
- Aluminum top trim available in standard paint finishes.

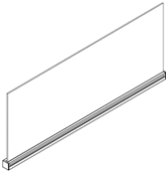
| DESCRIPTION | PRODUCT CODE | LIST PRICE | DIMENSIONS/INCHES | | |
|---|--------------|------------|-------------------|----|---|
| | | | H | W | D |
|  <p>18" H Felt Divider w/ Aluminum Trim for 1" Laminate Panel</p> | EVFPD1824W | 145 | 18 | 24 | 1 |
| | EVFPD1830W | 169 | 18 | 30 | 1 |
| | EVFPD1836W | 200 | 18 | 36 | 1 |
| | EVFPD1842W | 223 | 18 | 42 | 1 |
| | EVFPD1848W | 329 | 18 | 48 | 1 |
| | EVFPD1854W | 359 | 18 | 54 | 1 |
| | EVFPD1860W | 388 | 18 | 60 | 1 |
| | EVFPD1866W | 407 | 18 | 66 | 1 |
| | EVFPD1872W | 462 | 18 | 72 | 1 |

EVFDK06P - 6" PANEL MOUNTED FELT DIVIDER

- Privacy felt panel integrated with aluminum top trim.
- Attaches on top of panels to add privacy or divide space. Includes aluminum trim with channel and felt tile.
- Aluminum trim must be specified for entire station when ordering panel mount privacy felt.
- Felt and attachment hardware to ship separately.
- 9 mm felt material is tackable and is available in standard PET colors. Please specify.

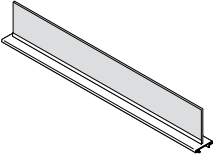
| DESCRIPTION | PRODUCT CODE | LIST PRICE Gr1 | DIMENSIONS/INCHES | | |
|--|--------------|-------------------|-------------------|----|-------|
| | | | H | W | D |
|  <p>6" Privacy felt panel integrated with aluminum top trim</p> | EVFDK0624P | 116 | 6 | 24 | 2 7/8 |
| | EVFDK0630P | 135 | 6 | 30 | 2 7/8 |
| | EVFDK0636P | 160 | 6 | 36 | 2 7/8 |
| | EVFDK0642P | 180 | 6 | 42 | 2 7/8 |
| | EVFDK0648P | 264 | 6 | 48 | 2 7/8 |
| | EVFDK0654P | 289 | 6 | 54 | 2 7/8 |
| | EVFDK0660P | 310 | 6 | 60 | 2 7/8 |
| | EVFDK0666P | 327 | 6 | 66 | 2 7/8 |
| | EVFDK0672P | 369 | 6 | 72 | 2 7/8 |

EVFDK09P - 9" PANEL MOUNTED FELT DIVIDER

- Privacy felt panel integrated with aluminum top trim.
- Attaches on top of panels to add privacy or divide space. Includes aluminum trim with channel and felt tile.
- Aluminum trim must be specified for entire station when ordering panel mount privacy felt.
- Felt and attachment hardware to ship separately.
- 9 mm felt material is tackable and is available in standard PET colors. Please specify.

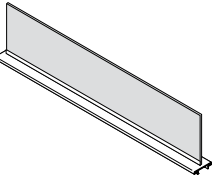
| DESCRIPTION | PRODUCT CODE | LIST PRICE Gr1 | DIMENSIONS/INCHES | | |
|---|--------------|-------------------|-------------------|----|-------|
| | | | H | W | D |
|  <p>9" Privacy felt panel integrated with aluminum top trim</p> | EVFDK0924P | 116 | 9 | 24 | 2 7/8 |
| | EVFDK0930P | 135 | 9 | 30 | 2 7/8 |
| | EVFDK0936P | 160 | 9 | 36 | 2 7/8 |
| | EVFDK0942P | 180 | 9 | 42 | 2 7/8 |
| | EVFDK0948P | 264 | 9 | 48 | 2 7/8 |
| | EVFDK0954P | 289 | 9 | 54 | 2 7/8 |
| | EVFDK0960P | 310 | 9 | 60 | 2 7/8 |
| | EVFDK0966P | 327 | 9 | 66 | 2 7/8 |
| | EVFDK0972P | 369 | 9 | 72 | 2 7/8 |

EVFDK12P - 12" PANEL MOUNTED FELT DIVIDER

- Privacy felt panel integrated with aluminum top trim.
- Attaches on top of panels to add privacy or divide space. Includes aluminum trim with channel and felt tile.
- Aluminum trim must be specified for entire station when ordering panel mount privacy felt.
- Felt and attachment hardware to ship separately.
- 9 mm felt material is tackable and is available in standard PET colors. Please specify.

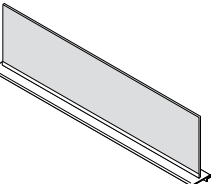
| DESCRIPTION | PRODUCT CODE | LIST PRICE Gr1 | DIMENSIONS/INCHES | | |
|---|--------------|-------------------|-------------------|----|-------|
| | | | H | W | D |
|  <p>12" Privacy felt panel integrated with aluminum top trim</p> | EVFDK1224P | 116 | 12 | 24 | 2 7/8 |
| | EVFDK1230P | 135 | 12 | 30 | 2 7/8 |
| | EVFDK1236P | 160 | 12 | 36 | 2 7/8 |
| | EVFDK1242P | 180 | 12 | 42 | 2 7/8 |
| | EVFDK1248P | 264 | 12 | 48 | 2 7/8 |
| | EVFDK1254P | 289 | 12 | 54 | 2 7/8 |
| | EVFDK1260P | 310 | 12 | 60 | 2 7/8 |



EVFDK12PN - 12" PANEL MOUNTED FELT DIVIDER, 1 NOTCH

- Privacy felt panel integrated with aluminum top trim.
- Attaches on top of panels to add privacy or divide space. Includes aluminum trim with channel and felt tile.
- Aluminum trim must be specified for entire station when ordering panel mount privacy felt.
- Felt and attachment hardware to ship separately.
- 9 mm felt material is tackable and is available in standard PET colors. Please specify.

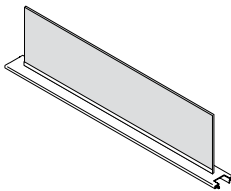
| DESCRIPTION | PRODUCT CODE | LIST PRICE Gr1 | DIMENSIONS/INCHES | | |
|--|--------------|-------------------|-------------------|-------|-------|
| | | | H | W | D |
|  <p>12" Privacy felt panel integrated with aluminum top trim with 1 Notch</p> | EVFDK1224PN | 116 | 12 | 22.68 | 2 7/8 |
| | EVFDK1230PN | 135 | 12 | 28.68 | 2 7/8 |
| | EVFDK1236PN | 160 | 12 | 34.68 | 2 7/8 |
| | EVFDK1242PN | 180 | 12 | 40.68 | 2 7/8 |
| | EVFDK1248PN | 264 | 12 | 46.68 | 2 7/8 |
| | EVFDK1254PN | 289 | 12 | 52.68 | 2 7/8 |
| | EVFDK1260PN | 310 | 12 | 58.68 | 2 7/8 |

EVFDK12PDN - 12" PANEL MOUNTED FELT DIVIDER, 2 NOTCHES

- Privacy felt panel integrated with aluminum top trim.
- Attaches on top of panels to add privacy or divide space. Includes aluminum trim with channel and felt tile.
- Aluminum trim must be specified for entire station when ordering panel mount privacy felt.
- Felt and attachment hardware to ship separately.
- 9 mm felt material is tackable and is available in standard PET colors. Please specify.

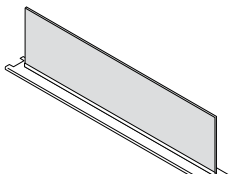
| DESCRIPTION | PRODUCT CODE | LIST PRICE Gr1 | DIMENSIONS/INCHES | | |
|---|--------------|-------------------|-------------------|-------|-------|
| | | | H | W | D |
|  <p>12" Privacy felt panel integrated with aluminum top trim with 2 Notches</p> | EVFDK1224PDN | 116 | 12 | 21.44 | 2 7/8 |
| | EVFDK1230PDN | 135 | 12 | 27.44 | 2 7/8 |
| | EVFDK1236PDN | 160 | 12 | 33.44 | 2 7/8 |
| | EVFDK1242PDN | 180 | 12 | 39.44 | 2 7/8 |
| | EVFDK1248PDN | 264 | 12 | 45.44 | 2 7/8 |
| | EVFDK1254PDN | 289 | 12 | 51.44 | 2 7/8 |
| | EVFDK1260PDN | 310 | 12 | 57.44 | 2 7/8 |

EVFDK18P - 18" PANEL MOUNTED FELT DIVIDER

- Privacy felt panel integrated with aluminum top trim.
- Attaches on top of panels to add privacy or divide space. Includes aluminum trim with channel and felt tile.
- Aluminum trim must be specified for entire station when ordering panel mount privacy felt.
- Felt and attachment hardware to ship separately.
- 9 mm felt material is tackable and is available in standard PET colors. Please specify.

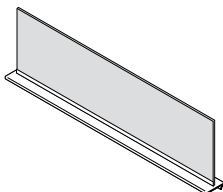
| DESCRIPTION | PRODUCT CODE | LIST PRICE Gr1 | DIMENSIONS/INCHES | | |
|---|--------------|-------------------|-------------------|----|-------|
| | | | H | W | D |
|  <p>18" Privacy felt panel integrated with aluminum top trim</p> | EVFDK01824P | 145 | 18 | 24 | 2 7/8 |
| | EVFDK01830P | 169 | 18 | 30 | 2 7/8 |
| | EVFDK01836P | 200 | 18 | 36 | 2 7/8 |
| | EVFDK01842P | 223 | 18 | 42 | 2 7/8 |
| | EVFDK01848P | 325 | 18 | 48 | 2 7/8 |
| | EVFDK01854P | 359 | 18 | 54 | 2 7/8 |
| | EVFDK01860P | 388 | 18 | 60 | 2 7/8 |
| | EVFDK01866P | 407 | 18 | 66 | 2 7/8 |
| | EVFDK01872P | 462 | 18 | 72 | 2 7/8 |

EVFPDK06XXPCF - 6" H PANEL MOUNT PRIVACY DIVIDER CEILING FILLER KIT

- Privacy Felt Divider integrated with aluminum top trim.
- Aluminum top trim available in standard paint finishes.
- Attaches on top of panels to add privacy or divide space.
- Includes aluminum trim with channel and Felt tile.
- Felt tile and attachment hardware to ship separately.
- 9 mm felt material is tackable and is available in standard PET colors. Please specify.
- PVC cap for closing gap at ceiling included.
- PVC cap available in white only.

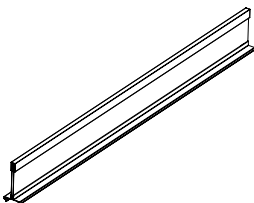
| DESCRIPTION | PRODUCT CODE | LIST PRICE | DIMENSIONS/INCHES | | |
|---|---------------|------------|-------------------|----|---|
| | | | H | W | D |
|  Panel Mount Felt Divider Ceiling Filler Kit | EVFPDK0618PCF | 110 | 6 | 18 | |
| | EVFPDK0624PCF | 131 | 6 | 24 | |
| | EVFPDK0630PCF | 156 | 6 | 30 | |
| | EVFPDK0636PCF | 183 | 6 | 36 | |
| | EVFPDK0642PCF | 206 | 6 | 42 | |
| | EVFPDK0648PCF | 304 | 6 | 48 | |
| | EVFPDK0654PCF | 329 | 6 | 54 | |
| | EVFPDK0660PCF | 358 | 6 | 60 | |
| | EVFPDK0666PCF | 376 | 6 | 66 | |
| | EVFPDK0672PCF | 424 | 6 | 72 | |

EVFPDK06XXPCFP - 6" H PANEL MOUNT PRIVACY DIVIDER CEILING FILLER KIT

- Privacy Felt Divider integrated with aluminum top trim.
- Aluminum top trim available in standard paint finishes.
- Aluminum trim is width of panel.
- Attaches on top of panels to add privacy or divide space.
- Includes aluminum trim with channel and Felt tile.
- Felt tile and attachment hardware to ship separately.
- 9 mm felt material is tackable and is available in standard PET colors. Please specify.
- Felt tile is longer and overhangs half of width of post.
- PVC cap for closing gap at ceiling included.
- PVC cap available in white only.

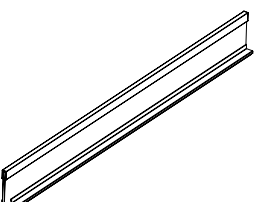
| DESCRIPTION | PRODUCT CODE | LIST PRICE | DIMENSIONS/INCHES | | |
|---|---------------|------------|-------------------|--------|---|
| | | | H | W | D |
|  Panel Mount Felt Divider Ceiling Filler at Post Kit | EVFPDK0619PCF | 131 | 6 | 19 3/4 | |
| | EVFPDK0625PCF | 156 | 6 | 25 3/4 | |
| | EVFPDK0631PCF | 183 | 6 | 31 3/4 | |
| | EVFPDK0637PCF | 206 | 6 | 37 3/4 | |
| | EVFPDK0643PCF | 304 | 6 | 43 3/4 | |
| | EVFPDK0649PCF | 329 | 6 | 49 3/4 | |
| | EVFPDK0655PCF | 358 | 6 | 55 3/4 | |
| | EVFPDK0661PCF | 376 | 6 | 61 3/4 | |
| | EVFPDK0667PCF | 424 | 6 | 67 3/4 | |
| | EVFPDK0673PCF | 475 | 6 | 73 3/4 | |

EVFPDK09XXPCF - 9" H PANEL MOUNT PRIVACY DIVIDER CEILING FILLER KIT

- Privacy Felt Divider integrated with aluminum top trim.
- Aluminum top trim available in standard paint finishes.
- Attaches on top of panels to add privacy or divide space.
- Includes aluminum trim with channel and Felt tile.
- Felt tile and attachment hardware to ship separately.
- 9 mm felt material is tackable and is available in standard PET colors. Please specify.
- PVC cap for closing gap at ceiling included.
- PVC cap available in white only.

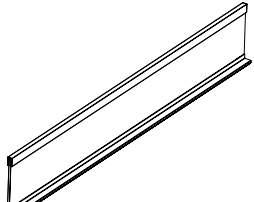
| DESCRIPTION | PRODUCT CODE | LIST PRICE | DIMENSIONS/INCHES | | |
|---|---------------|------------|-------------------|----|---|
| | | | H | W | D |
|  Panel Mount Felt Divider Ceiling Filler Kit | EVFPDK0918PCF | 110 | 9 | 18 | |
| | EVFPDK0924PCF | 131 | 9 | 24 | |
| | EVFPDK0930PCF | 156 | 9 | 30 | |
| | EVFPDK0936PCF | 183 | 9 | 36 | |
| | EVFPDK0942PCF | 206 | 9 | 42 | |
| | EVFPDK0948PCF | 304 | 9 | 48 | |
| | EVFPDK0954PCF | 329 | 9 | 54 | |
| | EVFPDK0960PCF | 358 | 9 | 60 | |
| | EVFPDK0966PCF | 376 | 9 | 66 | |
| | EVFPDK0972PCF | 424 | 9 | 72 | |



EVFPDK09XXPCFP - 9" H PANEL MOUNT PRIVACY DIVIDER CEILING FILLER KIT

- Privacy Felt Divider integrated with aluminum top trim.
- Aluminum trim is width of panel.
- Aluminum top trim available in standard paint finishes.
- Attaches on top of panels to add privacy or divide space.
- Includes aluminum trim with channel and Felt tile.
- Felt tile and attachment hardware to ship separately.
- 9 mm felt material is tackable and is available in standard PET colors. Please specify.
- Felt tile is longer and overhangs half of width of post.
- PVC cap for closing gap at ceiling included.
- PVC cap available in white only.

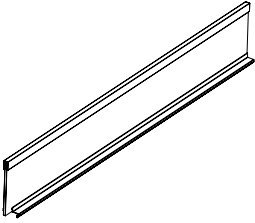
| DESCRIPTION | PRODUCT CODE | LIST PRICE | DIMENSIONS/INCHES | | |
|---|--------------|------------|-------------------|--------|---|
| | | | H | W | D |
|  Panel Mount Felt Divider Ceiling Filler at Post Kit | EVFDK0919PCF | 131 | 9 | 19 3/4 | |
| | EVFDK0925PCF | 156 | 9 | 25 3/4 | |
| | EVFDK0931PCF | 183 | 9 | 31 3/4 | |
| | EVFDK0937PCF | 206 | 9 | 37 3/4 | |
| | EVFDK0943PCF | 304 | 9 | 43 3/4 | |
| | EVFDK0949PCF | 329 | 9 | 49 3/4 | |
| | EVFDK0955PCF | 358 | 9 | 55 3/4 | |
| | EVFDK0961PCF | 376 | 9 | 61 3/4 | |
| | EVFDK0967PCF | 424 | 9 | 67 3/4 | |
| | EVFDK0973PCF | 475 | 9 | 73 3/4 | |

EVPTFC - CEILING FILLER PVC CAP FOR FELT DIVIDER

- To be installed on top on felt divider when used as ceiling filler.
- Field installed on top of felt divider to close gap at ceiling.
- Available in 18"-96" lengths.
- Available in white only.
- Felt divider with top trim kit to be ordered separately.

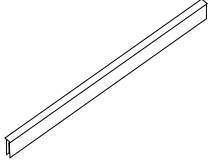
| DESCRIPTION | PRODUCT CODE | LIST PRICE | DIMENSIONS/INCHES | | |
|--|--------------|------------|-------------------|----|-----|
| | | | H | W | D |
|  PVC Cap for Felt Divider | EVPTFC18 | 17 | 1 3/8 | 18 | 3/4 |
| | EVPTFC24 | 19 | 1 3/8 | 24 | 3/4 |
| | EVPTFC30 | 24 | 1 3/8 | 30 | 3/4 |
| | EVPTFC36 | 27 | 1 3/8 | 36 | 3/4 |
| | EVPTFC42 | 29 | 1 3/8 | 42 | 3/4 |
| | EVPTFC48 | 43 | 1 3/8 | 48 | 3/4 |
| | EVPTFC54 | 47 | 1 3/8 | 54 | 3/4 |
| | EVPTFC60 | 49 | 1 3/8 | 60 | 3/4 |
| | EVPTFC66 | 53 | 1 3/8 | 66 | 3/4 |
| | EVPTFC72 | 58 | 1 3/8 | 72 | 3/4 |
| | EVPTFC78 | 64 | 1 3/8 | 78 | 3/4 |
| | EVPTFC84 | 69 | 1 3/8 | 84 | 3/4 |
| | EVPTFC90 | 75 | 1 3/8 | 90 | 3/4 |
| | EVPTFC96 | 81 | 1 3/8 | 96 | 3/4 |

EVFELTPXXHWR - ALUMINUM TOP TRIM WITH CHANNEL

- Top trim with channel.
- Available in standard paint colors.
- Note: Trim can span inline connector, but not a Post

| DESCRIPTION | PRODUCT CODE | LIST PRICE | DIMENSIONS/INCHES | | |
|---|--------------|------------|-------------------|----|-------|
| | | | H | W | D |
|  Aluminum Top Trip | EVFELTP18HWR | 43 | | 18 | 2.875 |
| | EVFELTP24HWR | 44 | | 24 | 2.875 |
| | EVFELTP30HWR | 51 | | 30 | 2.875 |
| | EVFELTP36HWR | 57 | | 36 | 2.875 |
| | EVFELTP42HWR | 64 | | 42 | 2.875 |
| | EVFELTP48HWR | 70 | | 48 | 2.875 |
| | EVFELTP54HWR | 76 | | 54 | 2.875 |
| | EVFELTP60HWR | 84 | | 60 | 2.875 |
| | EVFELTP66HWR | 92 | | 66 | 2.875 |
| | EVFELTP72HWR | 104 | | 72 | 2.875 |

EVFELTXXYP - FELT TILE

- Felt tile.
- Available in standard felt colors.
- Top trim with channel and PVC cap to be ordered separately.

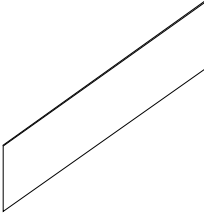
| DESCRIPTION | PRODUCT CODE | LIST PRICE | DIMENSIONS/INCHES | | |
|--|--------------|------------|-------------------|----|---|
| | | | H | W | D |
|  <p>Felt Tile - 6" High</p> | EVFELT0618P | 31 | 6 | 18 | |
| | EVFELT0624P | 39 | 6 | 24 | |
| | EVFELT0630P | 54 | 6 | 30 | |
| | EVFELT0636P | 69 | 6 | 36 | |
| | EVFELT0642P | 85 | 6 | 42 | |
| | EVFELT0648P | 105 | 6 | 48 | |
| | EVFELT0654P | 119 | 6 | 54 | |
| | EVFELT0660P | 132 | 6 | 60 | |
| | EVFELT0666P | 149 | 6 | 66 | |
| | EVFELT0672P | 163 | 6 | 72 | |
| <p>Felt Tile - 9" High</p> | EVFELT0918P | 53 | 9 | 18 | |
| | EVFELT0924P | 64 | 9 | 24 | |
| | EVFELT0930P | 75 | 9 | 30 | |
| | EVFELT0936P | 91 | 9 | 36 | |
| | EVFELT0942P | 102 | 9 | 42 | |
| | EVFELT0948P | 169 | 9 | 48 | |
| | EVFELT0954P | 185 | 9 | 54 | |
| | EVFELT0960P | 202 | 9 | 60 | |
| | EVFELT0966P | 218 | 9 | 66 | |
| | EVFELT0972P | 231 | 9 | 72 | |



EVPP - GLAZED FREESTANDING PRIVACY PANEL

- Includes panel with two connectors with T legs.
- 3" thick freestanding panels with leveling glides.
- 22" deep T-legs for stability (9.5" on each side)
- All Modules are Tempered Glass.
- Includes end of run trim.

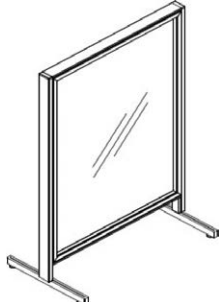
| | DESCRIPTION | PRODUCT CODE | LIST PRICE | | DIMENSIONS/INCHES | | |
|---|--|--------------|------------|----------|-------------------|----|------|
| | | | CLR | FRST ADD | H | W | D |
|  | Glazed Monolithic Freestanding Privacy Panel | EVPPXGT5418 | 833 | 181 | 54 | 18 | 27/8 |
| | | EVPPXGT5424 | 919 | 213 | 54 | 24 | 27/8 |
| | | EVPPXGT5430 | 999 | 247 | 54 | 30 | 27/8 |
| | | EVPPXGT5436 | 1075 | 279 | 54 | 36 | 27/8 |
| | | EVPPXGT5442 | 1161 | 314 | 54 | 42 | 27/8 |

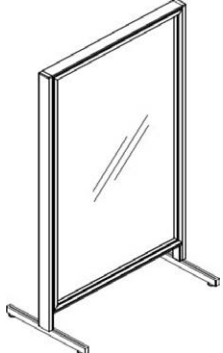
| | DESCRIPTION | PRODUCT CODE | LIST PRICE | | DIMENSIONS/INCHES | | |
|--|--|--------------|------------|----------|-------------------|----|------|
| | | | CLR | FRST ADD | H | W | D |
|  | Glazed Monolithic Freestanding Privacy Panel | EVPPXGT6618 | 960 | 218 | 66 | 18 | 27/8 |
| | | EVPPXGT6624 | 1054 | 255 | 66 | 24 | 27/8 |
| | | EVPPXGT6630 | 1150 | 291 | 66 | 30 | 27/8 |
| | | EVPPXGT6636 | 1237 | 327 | 66 | 36 | 27/8 |
| | | EVPPXGT6642 | 1340 | 369 | 66 | 42 | 27/8 |

EVPP - GLAZED MOBILE PRIVACY PANEL

- Includes panel with two connectors with T legs.
- 3" thick freestanding panels with 1" locking casters.
- 22" deep T-legs for stability (9.5" on each side)
- All Modules are Tempered Glass.
- Includes end of run trim.

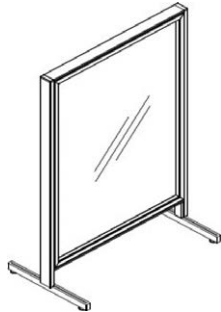
| DESCRIPTION | PRODUCT CODE | LIST PRICE | | | DIMENSIONS/INCHES | | |
|---|--------------|------------|----------|---------|-------------------|----|-------|
| | | CLR | FRST ADD | WRW ADD | H | W | D |
|  Mobile Glazed Monolithic Privacy Panel | EVPPXGT5418M | 905 | 181 | 608 | 54 | 18 | 2 7/8 |
| | EVPPXGT5424M | 988 | 216 | 753 | 54 | 24 | 2 7/8 |
| | EVPPXGT5430M | 1069 | 247 | 894 | 54 | 30 | 2 7/8 |
| | EVPPXGT5436M | 1146 | 279 | 1038 | 54 | 36 | 2 7/8 |
| | EVPPXGT5442M | 1232 | 313 | 1183 | 54 | 42 | 2 7/8 |

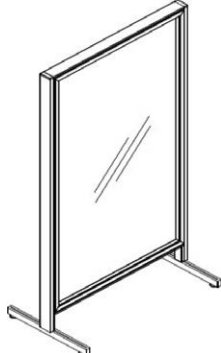
| DESCRIPTION | PRODUCT CODE | LIST PRICE | | | DIMENSIONS/INCHES | | |
|--|--------------|------------|----------|---------|-------------------|----|-------|
| | | CLR | FRST ADD | WRW ADD | H | W | D |
|  Mobile Glazed Monolithic Privacy Panel | EVPPXGT6618M | 1029 | 218 | 748 | 66 | 18 | 2 7/8 |
| | EVPPXGT6624M | 1124 | 255 | 923 | 66 | 24 | 2 7/8 |
| | EVPPXGT6630M | 1219 | 292 | 1097 | 66 | 30 | 2 7/8 |
| | EVPPXGT6636M | 1307 | 328 | 1269 | 66 | 36 | 2 7/8 |
| | EVPPXGT6642M | 1410 | 369 | 1449 | 66 | 42 | 2 7/8 |



EVPP - MONOLITHIC PRIVACY PANEL - RIBBED POLYCARBONATE

- Includes panel with two connectors with T legs.
- 3" thick freestanding panels with leveling glides
- 22" deep T-legs for stability (9.5" on each side)
- Ribbed Panels are semi-private translucent polycarbonate.
- Includes end of run trim.

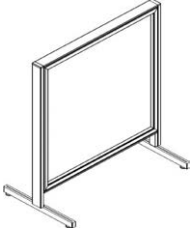
| DESCRIPTION | PRODUCT CODE | LIST PRICE | DIMENSIONS/INCHES | | |
|---|--------------|------------|-------------------|----|-------|
| | | | H | W | D |
|  Freestanding Ribbed Monolithic Privacy Panel | EVPPXGR4218 | 761 | 42 | 18 | 2 7/8 |
| | EVPPXGR4224 | 797 | 42 | 24 | 2 7/8 |
| | EVPPXGR4230 | 868 | 42 | 30 | 2 7/8 |
| | EVPPXGR4236 | 939 | 42 | 36 | 2 7/8 |
| | EVPPXGR4242 | 1012 | 42 | 42 | 2 7/8 |

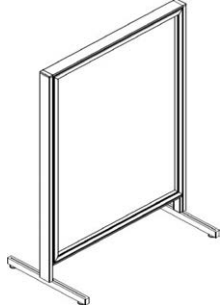
| DESCRIPTION | PRODUCT CODE | LIST PRICE | DIMENSIONS/INCHES | | |
|--|--------------|------------|-------------------|----|-------|
| | | | H | W | D |
|  Freestanding Ribbed Monolithic Privacy Panel | EVPPXGR5418 | 891 | 54 | 18 | 2 7/8 |
| | EVPPXGR5424 | 946 | 54 | 24 | 2 7/8 |
| | EVPPXGR5430 | 1028 | 54 | 30 | 2 7/8 |
| | EVPPXGR5436 | 1111 | 54 | 36 | 2 7/8 |
| | EVPPXGR5442 | 1201 | 54 | 42 | 2 7/8 |

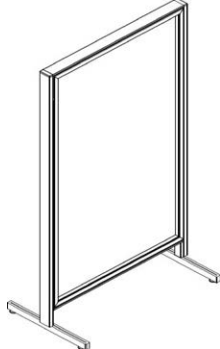
| DESCRIPTION | PRODUCT CODE | LIST PRICE | DIMENSIONS/INCHES | | |
|---|--------------|------------|-------------------|----|-------|
| | | | H | W | D |
|  Freestanding Ribbed Monolithic Privacy Panel | EVPPXGR6618 | 976 | 66 | 18 | 2 7/8 |
| | EVPPXGR6624 | 1078 | 66 | 24 | 2 7/8 |
| | EVPPXGR6630 | 1173 | 66 | 30 | 2 7/8 |
| | EVPPXGR6636 | 1267 | 66 | 36 | 2 7/8 |
| | EVPPXGR6642 | 1369 | 66 | 42 | 2 7/8 |

EVPP - MONOLITHIC PRIVACY PANEL - RIBBED POLYCARBONATE

- Includes panel with two connectors with T legs.
- 3" thick freestanding panels with 1" locking casters.
- 22" deep T-legs for stability (9.5" on each side)
- Ribbed Panels are semi-private translucent polycarbonate.
- Includes end of run trim.

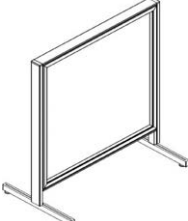
| | DESCRIPTION | PRODUCT CODE | LIST PRICE | DIMENSIONS/INCHES | | |
|---|--|--------------|------------|-------------------|----|-------|
| | | | | H | W | D |
|  | Mobile Ribbed Monolithic Privacy Panel | EVPPXGR4218M | 830 | 42 | 18 | 2 7/8 |
| | | EVPPXGR4224M | 868 | 42 | 24 | 2 7/8 |
| | | EVPPXGR4230M | 939 | 42 | 30 | 2 7/8 |
| | | EVPPXGR4236M | 1009 | 42 | 36 | 2 7/8 |
| | | EVPPXGR4242M | 1082 | 42 | 42 | 2 7/8 |

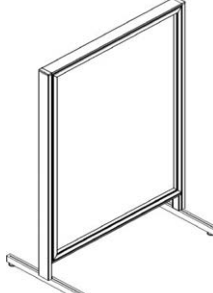
| | DESCRIPTION | PRODUCT CODE | LIST PRICE | DIMENSIONS/INCHES | | |
|--|--|--------------|------------|-------------------|----|-------|
| | | | | H | W | D |
|  | Mobile Ribbed Monolithic Privacy Panel | EVPPXGR5418M | 965 | 54 | 18 | 2 7/8 |
| | | EVPPXGR5424M | 1017 | 54 | 24 | 2 7/8 |
| | | EVPPXGR5430M | 1100 | 54 | 30 | 2 7/8 |
| | | EVPPXGR5436M | 1182 | 54 | 36 | 2 7/8 |
| | | EVPPXGR5442M | 1272 | 54 | 42 | 2 7/8 |

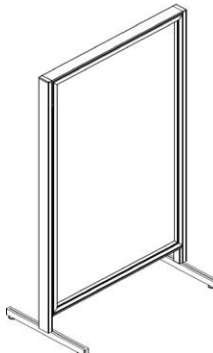
| | DESCRIPTION | PRODUCT CODE | LIST PRICE | DIMENSIONS/INCHES | | |
|---|--|--------------|------------|-------------------|----|-------|
| | | | | H | W | D |
|  | Mobile Ribbed Monolithic Privacy Panel | EVPPXGR6618M | 1047 | 66 | 18 | 2 7/8 |
| | | EVPPXGR6624M | 1150 | 66 | 24 | 2 7/8 |
| | | EVPPXGR6630M | 1173 | 66 | 30 | 2 7/8 |
| | | EVPPXGR6636M | 1337 | 66 | 36 | 2 7/8 |
| | | EVPPXGR6642M | 1438 | 66 | 42 | 2 7/8 |



EVPP - MONOLITHIC PRIVACY PANEL - GLAZED

- Includes panel with two connectors with T legs
- 3" thick freestanding panels with flat foot
- 22" deep T-legs for stability (9.5" on each side)
- Glazed Panels are available in tempered Clear glass (CLR) and Frosted glass (FRST)
- Includes end of run trim

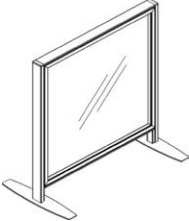
| DESCRIPTION | PRODUCT CODE | LIST PRICE | | DIMENSIONS/INCHES | | |
|--|--------------|------------|----------|-------------------|----|-------|
| | | CLR | FRST ADD | H | W | D |
|  Freestanding Glazed Monolithic Privacy Panel | EVPPXGTF4218 | 715 | 148 | 42 | 18 | 2 7/8 |
| | EVPPXGTF4224 | 787 | 179 | 42 | 24 | 2 7/8 |
| | EVPPXGTF4230 | 855 | 203 | 42 | 30 | 2 7/8 |
| | EVPPXGTF4236 | 920 | 229 | 42 | 36 | 2 7/8 |
| | EVPPXGTF4242 | 994 | 260 | 42 | 42 | 2 7/8 |

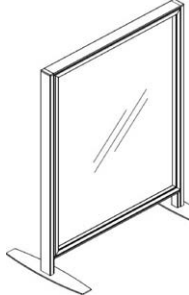
| DESCRIPTION | PRODUCT CODE | LIST PRICE | | DIMENSIONS/INCHES | | |
|---|--------------|------------|----------|-------------------|----|-------|
| | | CLR | FRST ADD | H | W | D |
|  Freestanding Glazed Monolithic Privacy Panel | EVPPXGTF5418 | 833 | 181 | 54 | 18 | 2 7/8 |
| | EVPPXGTF5424 | 919 | 213 | 54 | 24 | 2 7/8 |
| | EVPPXGTF5430 | 999 | 247 | 54 | 30 | 2 7/8 |
| | EVPPXGTF5436 | 1075 | 279 | 54 | 36 | 2 7/8 |
| | EVPPXGTF5442 | 1161 | 279 | 54 | 42 | 2 7/8 |

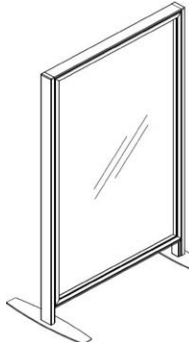
| DESCRIPTION | PRODUCT CODE | LIST PRICE | | DIMENSIONS/INCHES | | |
|--|--------------|------------|----------|-------------------|----|-------|
| | | CLR | FRST ADD | H | W | D |
|  Freestanding Glazed Monolithic Privacy Panel | EVPPXGTF6618 | 960 | 218 | 66 | 18 | 2 7/8 |
| | EVPPXGTF6624 | 1054 | 255 | 66 | 24 | 2 7/8 |
| | EVPPXGTF6630 | 1150 | 291 | 66 | 30 | 2 7/8 |
| | EVPPXGTF6636 | 1237 | 327 | 66 | 36 | 2 7/8 |
| | EVPPXGTF6642 | 1340 | 368 | 66 | 42 | 2 7/8 |

EVPP - MONOLITHIC PRIVACY PANEL - RIBBED POLYCARBONATE

- Includes panel with two connectors with T legs
- 3" thick freestanding panels with flat foot
- 22" deep T-legs for stability (9.5" on each side)
- Ribbed Panels are semi-private translucent polycarbonate.
- Includes end of run trim.

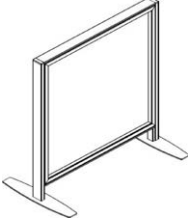
| | DESCRIPTION | PRODUCT CODE | LIST PRICE | DIMENSIONS/INCHES | | |
|---|--|--------------|------------|-------------------|----|-------|
| | | | | H | W | D |
|  | Freestanding Ribbed Monolithic Privacy Panel | EVPPXGRF4218 | 761 | 42 | 18 | 2 7/8 |
| | | EVPPXGRF4224 | 797 | 42 | 24 | 2 7/8 |
| | | EVPPXGRF4230 | 868 | 42 | 30 | 2 7/8 |
| | | EVPPXGRF4236 | 939 | 42 | 36 | 2 7/8 |
| | | EVPPXGRF4242 | 1012 | 42 | 42 | 2 7/8 |

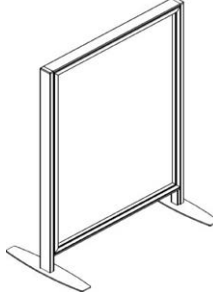
| | DESCRIPTION | PRODUCT CODE | LIST PRICE | DIMENSIONS/INCHES | | |
|--|--|--------------|------------|-------------------|----|-------|
| | | | | H | W | D |
|  | Freestanding Ribbed Monolithic Privacy Panel | EVPPXGRF5418 | 891 | 54 | 18 | 2 7/8 |
| | | EVPPXGRF5424 | 946 | 54 | 24 | 2 7/8 |
| | | EVPPXGRF5430 | 1028 | 54 | 30 | 2 7/8 |
| | | EVPPXGRF5436 | 1111 | 54 | 36 | 2 7/8 |
| | | EVPPXGRF5442 | 1201 | 54 | 42 | 2 7/8 |

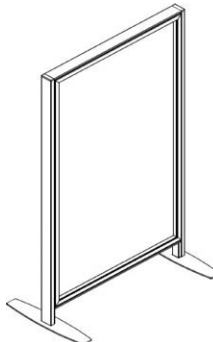
| | DESCRIPTION | PRODUCT CODE | LIST PRICE | DIMENSIONS/INCHES | | |
|---|--|--------------|------------|-------------------|----|-------|
| | | | | H | W | D |
|  | Freestanding Ribbed Monolithic Privacy Panel | EVPPXGRF6618 | 976 | 66 | 18 | 2 7/8 |
| | | EVPPXGRF6624 | 1078 | 66 | 24 | 2 7/8 |
| | | EVPPXGRF6630 | 1173 | 66 | 30 | 2 7/8 |
| | | EVPPXGRF6636 | 1267 | 66 | 36 | 2 7/8 |
| | | EVPPXGRF6642 | 1369 | 66 | 42 | 2 7/8 |



EVPP - MONOLITHIC PRIVACY PANEL - 78" HIGH

- Includes panel with two connectors with T legs.
- 3" thick freestanding panels with leveling glides
- 22" deep T-legs for stability (9.5" on each side)
- Glazed Panels are available in tempered Clear glass (CLR) and Frosted glass (FRST)
- Ribbed Panels are semi-private translucent polycarbonate.
- Includes end of run trim.
- Includes 48"H Glazed module and 29"H legs

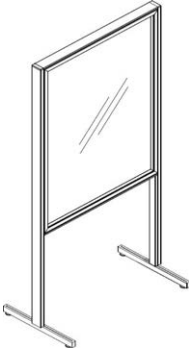
| | DESCRIPTION | PRODUCT CODE | LIST PRICE | | DIMENSIONS/INCHES | | |
|---|--|--------------|------------|----------|-------------------|----|-------|
| | | | CLR | FRST ADD | H | W | D |
|  | Freestanding Glazed Monolithic Privacy Panel | EVPPXGT7824 | 984 | 216 | 78 | 24 | 2 7/8 |
| | | EVPPXGT7830 | 1063 | 247 | 78 | 30 | 2 7/8 |
| | | EVPPXGT7836 | 1142 | 279 | 78 | 36 | 2 7/8 |
| | | EVPPXGT7842 | 1229 | 313 | 78 | 42 | 2 7/8 |

EVPP - MONOLITHIC PRIVACY PANEL - 78" HIGH

- Includes panel with two connectors with T legs.
- 3" thick freestanding panels with leveling glides
- 22" deep T-legs for stability (9.5" on each side)
- Glazed Panels are available in tempered Clear glass (CLR) and Frosted glass (FRST)
- Ribbed Panels are semi-private translucent polycarbonate.
- Includes end of run trim.
- Includes 48"H Ribbled module and 29"H legs

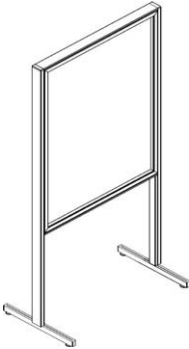
| | DESCRIPTION | PRODUCT CODE | LIST PRICE | DIMENSIONS/INCHES | | |
|---|--|--------------|------------|-------------------|----|-------|
| | | | | H | W | D |
|  | Freestanding Ribbed Monolithic Privacy Panel | EVPPXGR7824 | 1020 | 78 | 24 | 2 7/8 |
| | | EVPPXGR7830 | 1104 | 78 | 30 | 2 7/8 |
| | | EVPPXGR7836 | 1020 | 78 | 36 | 2 7/8 |
| | | EVPPXGR7842 | 1276 | 78 | 42 | 2 7/8 |

EVPP - MONOLITHIC PRIVACY PANEL - 78" HIGH

- Includes panel with two connectors with T legs.
- 3" thick freestanding panels with 1" locking casters
- 22" deep T-legs for stability (9.5" on each side)
- Glazed Panels are available in tempered Clear glass (CLR) and Frosted glass (FRST)
- Ribbed Panels are semi-private translucent polycarbonate.
- Includes end of run trim.
- Includes 48"H Glazed module and 29"H legs

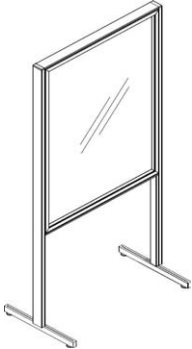
| DESCRIPTION | PRODUCT CODE | LIST PRICE | | DIMENSIONS/INCHES | | | |
|---|--|--------------|----------|-------------------|----|----|-------|
| | | CLR | FRST ADD | H | W | D | |
|  | Mobile Glazed Monolithic Privacy Panel | EVPPXGT7824M | 1055 | 213 | 78 | 24 | 2 7/8 |
| | | EVPPXGT7830M | 1136 | 247 | 78 | 30 | 2 7/8 |
| | | EVPPXGT7836M | 1213 | 279 | 78 | 36 | 2 7/8 |
| | | EVPPXGT7842M | 1297 | 314 | 78 | 42 | 2 7/8 |

EVPP - MONOLITHIC PRIVACY PANEL - 78" HIGH

- Includes panel with two connectors with T legs.
- 3" thick freestanding panels with 1" locking casters
- 22" deep T-legs for stability (9.5" on each side)
- Glazed Panels are available in tempered Clear glass (CLR) and Frosted glass (FRST)
- Ribbed Panels are semi-private translucent polycarbonate.
- Includes end of run trim.
- Includes 48"H Ribbed module and 29"H legs

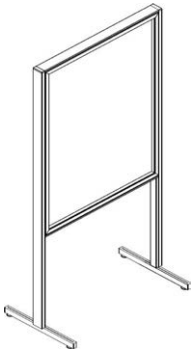
| DESCRIPTION | PRODUCT CODE | LIST PRICE | DIMENSIONS/INCHES | | | |
|---|--|--------------|-------------------|----|----|-------|
| | | | H | W | D | |
|  | Mobile Ribbed Monolithic Privacy Panel | EVPPXGR7824M | 1092 | 78 | 24 | 2 7/8 |
| | | EVPPXGR7830M | 1174 | 78 | 30 | 2 7/8 |
| | | EVPPXGR7836M | 1092 | 78 | 36 | 2 7/8 |
| | | EVPPXGR7842M | 1347 | 78 | 42 | 2 7/8 |



EVPP - MONOLITHIC PRIVACY PANEL - 78" HIGH

- Includes panel with two connectors with T legs
- 3" thick freestanding panels with flat foot
- 22" deep T-legs for stability (9.5" on each side)
- Glazed Panels are available in tempered Clear glass (CLR) and Frosted glass (FRST)
- Ribbed Panels are semi-private translucent polycarbonate.
- Includes end of run trim.
- Includes 48"H Glazed module and 29"H legs

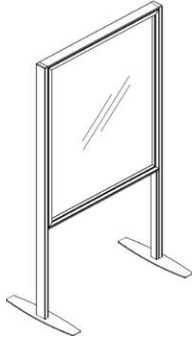

| DESCRIPTION | PRODUCT CODE | LIST PRICE | | DIMENSIONS/INCHES | | |
|--|--------------|------------|----------|-------------------|----|-------|
| | | CLR | FRST ADD | H | W | D |
| Freestanding Glazed Monolithic Privacy Panel | EVPPXGTF7824 | 984 | 216 | 78 | 24 | 2 7/8 |
| | EVPPXGTF7830 | 1063 | 247 | 78 | 30 | 2 7/8 |
| | EVPPXGTF7836 | 1142 | 279 | 78 | 36 | 2 7/8 |
| | EVPPXGTF7842 | 1229 | 313 | 78 | 42 | 2 7/8 |

EVPP - MONOLITHIC PRIVACY PANEL - 78" HIGH

- Includes panel with two connectors with T legs
- 3" thick freestanding panels with flat foot
- 22" deep T-legs for stability (9.5" on each side)
- Glazed Panels are available in tempered Clear glass (CLR) and Frosted glass (FRST)
- Ribbed Panels are semi-private translucent polycarbonate.
- Includes end of run trim.
- Includes 48"H Ribbed module and 29"H legs

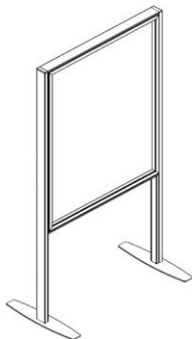

| DESCRIPTION | PRODUCT CODE | LIST PRICE | DIMENSIONS/INCHES | | |
|--|--------------|------------|-------------------|----|-------|
| | | | H | W | D |
| Freestanding Ribbed Monolithic Privacy Panel | EVPPXGRF7824 | 1020 | 78 | 24 | 2 7/8 |
| | EVPPXGRF7830 | 1104 | 78 | 30 | 2 7/8 |
| | EVPPXGRF7836 | 1020 | 78 | 36 | 2 7/8 |
| | EVPPXGRF7842 | 1276 | 78 | 42 | 2 7/8 |

EVPP - GLAZED PRIVACY PANEL

- Includes panel with two connectors with T legs.
- 3" thick freestanding panels with leveling glides
- 22" deep T-legs for stability (9.5" on each side)
- All Modules are Tempered Glass.
- Available in clear glass (CLR) and frosted glass (FRST)
- Includes end of run trim.

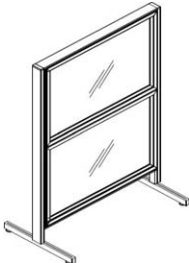
| DESCRIPTION | PRODUCT CODE | LIST PRICE | | DIMENSIONS/INCHES | | |
|---|--------------|------------|----------|-------------------|----|-------|
| | | CLR | FRST ADD | H | W | D |
|  Freestanding Glazed Privacy Panel | EVPPGT5424 | 949 | 228 | 54 | 24 | 2 7/8 |
| | EVPPGT5430 | 267 | 267 | 54 | 30 | 2 7/8 |
| | EVPPGT5436 | 303 | 303 | 54 | 36 | 2 7/8 |
| | EVPPGT5442 | 343 | 343 | 54 | 42 | 2 7/8 |
| | EVPPGT5448 | 383 | 383 | 54 | 48 | 2 7/8 |
| | EVPPGT5454 | 425 | 425 | 54 | 54 | 2 7/8 |
| | EVPPGT5460 | 460 | 460 | 54 | 60 | 2 7/8 |

EVPP - GLAZED PRIVACY PANEL

- Includes panel with two connectors with T legs.
- 3" thick freestanding panels with leveling glides
- 22" deep T-legs for stability (9.5" on each side)
- All Modules are Tempered Glass.
- Available in clear glass (CLR) and frosted glass (FRST)
- Includes end of run trim.

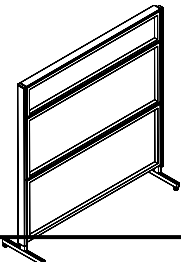
| DESCRIPTION | PRODUCT CODE | LIST PRICE | | DIMENSIONS/INCHES | | |
|--|--------------|------------|----------|-------------------|----|-------|
| | | CLR | FRST ADD | H | W | D |
|  Freestanding Glazed Privacy Panel | EVPPGT6624 | 1185 | 308 | 66 | 24 | 2 7/8 |
| | EVPPGT6630 | 1300 | 358 | 66 | 30 | 2 7/8 |
| | EVPPGT6636 | 1481 | 426 | 66 | 36 | 2 7/8 |
| | EVPPGT6642 | 1606 | 477 | 66 | 42 | 2 7/8 |
| | EVPPGT6648 | 1733 | 531 | 66 | 48 | 2 7/8 |
| | EVPPGT6654 | 1875 | 587 | 66 | 54 | 2 7/8 |
| | EVPPGT6660 | 2030 | 645 | 66 | 60 | 2 7/8 |

EVPP - MOBILE GLAZED PRIVACY PANEL

- Includes panel with two connectors with T legs.
- 3" thick freestanding panels with 1" locking casters.
- 22" deep T-legs for stability (9.5" on each side)
- All Modules are Tempered Glass.
- Available in clear glass (CLR) and frosted glass (FRST)
- Includes end of run trim.

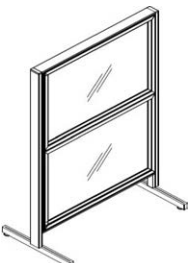
| DESCRIPTION | PRODUCT CODE | LIST PRICE | | DIMENSIONS/INCHES | | |
|---|--------------|------------|----------|-------------------|----|-------|
| | | CLR | FRST ADD | H | W | D |
|  Mobile Glazed Privacy Panel | EVPPGT5424M | 1019 | 229 | 54 | 24 | 2 7/8 |
| | EVPPGT5430M | 1113 | 268 | 54 | 30 | 2 7/8 |
| | EVPPGT5436M | 1204 | 303 | 54 | 36 | 2 7/8 |
| | EVPPGT5442M | 1304 | 343 | 54 | 42 | 2 7/8 |
| | EVPPGT5448M | 1402 | 383 | 54 | 48 | 2 7/8 |
| | EVPPGT5454M | 1505 | 425 | 54 | 54 | 2 7/8 |
| | EVPPGT5460M | 1595 | 460 | 54 | 60 | 2 7/8 |



EVPP - MOBILE GLAZED PRIVACY PANEL

- Includes panel with two connectors with T legs.
- 3" thick freestanding panels with 1" locking casters.
- 22" deep T-legs for stability (9.5" on each side)
- All Modules are Tempered Glass.
- Available in clear glass (CLR) and frosted glass (FRST)
- Includes end of run trim.

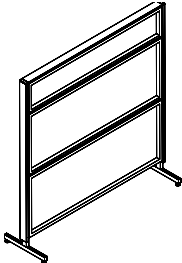
| DESCRIPTION | PRODUCT CODE | LIST PRICE | | DIMENSIONS/INCHES | | |
|--|--------------|------------|----------|-------------------|----|-------|
| | | CLR | FRST ADD | H | W | D |
|  <p>Mobile Glazed Privacy Panel</p> | EVPPGT6624M | 1256 | 310 | 66 | 24 | 2 7/8 |
| | EVPPGT6630M | 1371 | 356 | 66 | 30 | 2 7/8 |
| | EVPPGT6636M | 1550 | 426 | 66 | 36 | 2 7/8 |
| | EVPPGT6642M | 1677 | 477 | 66 | 42 | 2 7/8 |
| | EVPPGT6648M | 1803 | 531 | 66 | 48 | 2 7/8 |
| | EVPPGT6654M | 1946 | 583 | 66 | 54 | 2 7/8 |
| | EVPPGT6660M | 2098 | 646 | 66 | 60 | 2 7/8 |

EVPP - LAMINATE GLAZED PRIVACY PANEL

- Includes panel with two connectors with T legs.
- 3" thick freestanding panels with leveling glides
- 22" deep T-legs for stability (9.5" on each side)
- All Modules are Tempered Glass.
- Bottom Two Modules are Laminate w/12" Tempered Glass on top.
- Includes end of run trim.

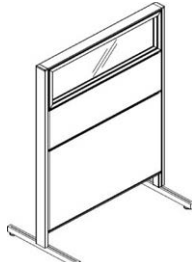
| DESCRIPTION | PRODUCT CODE | LIST PRICE | | DIMENSIONS/INCHES | | |
|--|--------------|------------|----------|-------------------|----|-------|
| | | CLR | FRST ADD | H | W | D |
|  <p>Freestanding Laminate Glazed Privacy Panel</p> | EVPPHGTU5424 | 1158 | 158 | 54 | 24 | 2 7/8 |
| | EVPPHGTU5430 | 1285 | 183 | 54 | 30 | 2 7/8 |
| | EVPPHGTU5436 | 1414 | 211 | 54 | 36 | 2 7/8 |
| | EVPPHGTU5442 | 1542 | 236 | 54 | 42 | 2 7/8 |
| | EVPPHGTU5448 | 1670 | 260 | 54 | 48 | 2 7/8 |
| | EVPPHGTU5454 | 1811 | 289 | 54 | 54 | 2 7/8 |
| | EVPPHGTU5460 | 1941 | 314 | 54 | 60 | 2 7/8 |

EVPP - LAMINATE GLAZED PRIVACY PANEL

- Includes panel with two connectors with T legs.
- 3" thick freestanding panels with leveling glides
- 22" deep T-legs for stability (9.5" on each side)
- Bottom Two Modules are Laminate w/12" Tempered Glass on top.
- Includes end of run trim.

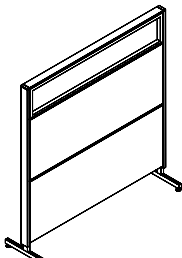
| DESCRIPTION | PRODUCT CODE | LIST PRICE | | DIMENSIONS/INCHES | | |
|---|--------------|------------|----------|-------------------|----|-------|
| | | CLR | FRST ADD | H | W | D |
|  <p>Freestanding Laminate Glazed Privacy Panel</p> | EVPPHGTU6624 | 1295 | 180 | 66 | 24 | 2 7/8 |
| | EVPPHGTU6630 | 1446 | 209 | 66 | 30 | 2 7/8 |
| | EVPPHGTU6636 | 1626 | 246 | 66 | 36 | 2 7/8 |
| | EVPPHGTU6642 | 1774 | 272 | 66 | 42 | 2 7/8 |
| | EVPPHGTU6648 | 1920 | 304 | 66 | 48 | 2 7/8 |
| | EVPPHGTU6654 | 2088 | 337 | 66 | 54 | 2 7/8 |
| | EVPPHGTU6660 | 2271 | 372 | 66 | 60 | 2 7/8 |

EVPP - MOBILE LAMINATE GLAZED PRIVACY PANEL

- Includes panel with two connectors with T legs.
- 3" thick freestanding panels with 1" locking casters.
- 22" deep T-legs for stability (9.5" on each side)
- Bottom Two Modules are Laminate w/12" Tempered Glass on top.
- Includes end of run trim.

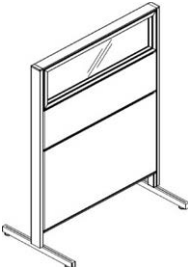
| DESCRIPTION | PRODUCT CODE | LIST PRICE | | DIMENSIONS/INCHES | | |
|---|---------------|------------|----------|-------------------|----|-------|
| | | CLR | FRST ADD | H | W | D |
|  <p>Mobile Laminate Glazed Privacy Panel</p> | EVPPHGTU5424M | 1229 | 158 | 54 | 24 | 2 7/8 |
| | EVPPHGTU5430M | 1355 | 183 | 54 | 30 | 2 7/8 |
| | EVPPHGTU5436M | 1485 | 209 | 54 | 36 | 2 7/8 |
| | EVPPHGTU5442M | 1615 | 236 | 54 | 42 | 2 7/8 |
| | EVPPHGTU5448M | 1741 | 261 | 54 | 48 | 2 7/8 |
| | EVPPHGTU5454M | 1880 | 290 | 54 | 54 | 2 7/8 |
| | EVPPHGTU5460M | 2011 | 315 | 54 | 60 | 2 7/8 |

EVPP - MOBILE LAMINATE GLAZED PRIVACY PANEL

- Includes panel with two connectors with T legs.
- 3" thick freestanding panels with 1" locking casters.
- 22" deep T-legs for stability (9.5" on each side)
- Bottom Two Modules are Laminate w/12" Tempered Glass on top.
- Includes end of run trim.

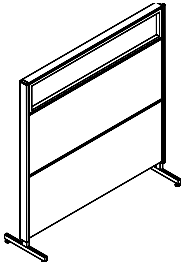
| DESCRIPTION | PRODUCT CODE | LIST PRICE | | DIMENSIONS/INCHES | | |
|--|---------------|------------|----------|-------------------|----|-------|
| | | CLR | FRST ADD | H | W | D |
|  <p>Mobile Laminate Glazed Privacy Panel</p> | EVPPHGTU6624M | 1366 | 180 | 66 | 24 | 2 7/8 |
| | EVPPHGTU6630M | 1516 | 207 | 66 | 30 | 2 7/8 |
| | EVPPHGTU6636M | 1697 | 247 | 66 | 36 | 2 7/8 |
| | EVPPHGTU6642M | 1844 | 271 | 66 | 42 | 2 7/8 |
| | EVPPHGTU6648M | 1993 | 303 | 66 | 48 | 2 7/8 |
| | EVPPHGTU6654M | 2158 | 337 | 66 | 54 | 2 7/8 |
| | EVPPHGTU6660M | 2341 | 372 | 66 | 60 | 2 7/8 |

EVPP - LAMINATE GLAZED PRIVACY PANEL

- Includes panel with two connectors with T legs.
- 3" thick freestanding panels with leveling glides
- 22" deep T-legs for stability (9.5" on each side)
- All Modules are Tempered Glass.
- Laminate Base Module w/24" Tempered Glass above.
- Includes end of run trim.

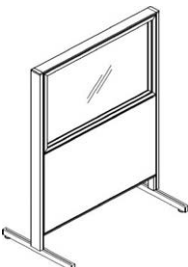
| DESCRIPTION | PRODUCT CODE | LIST PRICE | | DIMENSIONS/INCHES | | |
|---|--------------|------------|----------|-------------------|----|-------|
| | | CLR | FRST ADD | H | W | D |
|  <p>Freestanding Laminate Glazed Privacy Panel</p> | EVPPHGT5424 | 1003 | 127 | 54 | 24 | 2 7/8 |
| | EVPPHGT5430 | 1114 | 150 | 54 | 30 | 2 7/8 |
| | EVPPHGT5436 | 1229 | 170 | 54 | 36 | 2 7/8 |
| | EVPPHGT5442 | 1341 | 193 | 54 | 42 | 2 7/8 |
| | EVPPHGT5448 | 1450 | 218 | 54 | 48 | 2 7/8 |
| | EVPPHGT5454 | 1570 | 240 | 54 | 54 | 2 7/8 |
| | EVPPHGT5460 | 1676 | 262 | 54 | 60 | 2 7/8 |



EVPP - LAMINATE GLAZED PRIVACY PANEL

- Includes panel with two connectors with T legs.
- 3" thick freestanding panels with leveling glides
- 22" deep T-legs for stability (9.5" on each side)
- Laminate Base Module w/36" Tempered Glass above.
- Includes end of run trim.

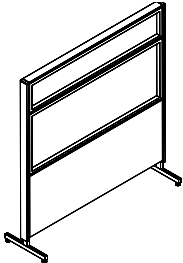
| | DESCRIPTION | PRODUCT CODE | LIST PRICE | | DIMENSIONS/INCHES | | |
|---|--|--------------|------------|----------|-------------------|----|-------|
| | | | CLR | FRST ADD | H | W | D |
|  | Freestanding Laminate Glazed Privacy Panel | EVPPHGT6624 | 1241 | 167 | 66 | 24 | 2 7/8 |
| | | EVPPHGT6630 | 1374 | 193 | 66 | 30 | 2 7/8 |
| | | EVPPHGT6636 | 1547 | 229 | 66 | 36 | 2 7/8 |
| | | EVPPHGT6642 | 1678 | 255 | 66 | 42 | 2 7/8 |
| | | EVPPHGT6648 | 1814 | 282 | 66 | 48 | 2 7/8 |
| | | EVPPHGT6654 | 1969 | 314 | 66 | 54 | 2 7/8 |
| | | EVPPHGT6660 | 2149 | 348 | 66 | 60 | 2 7/8 |

EVPP - MOBILE LAMINATE GLAZED PRIVACY PANEL

- Includes panel with two connectors with T legs.
- 3" thick freestanding panels with 1" locking casters.
- 22" deep T-legs for stability (9.5" on each side)
- Laminate Base Module w/36" Tempered Glass above.
- Includes end of run trim.

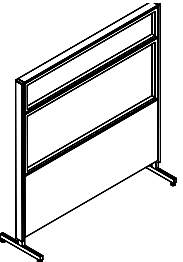
| | DESCRIPTION | PRODUCT CODE | LIST PRICE | | DIMENSIONS/INCHES | | |
|--|--------------------------------------|--------------|------------|----------|-------------------|----|-------|
| | | | CLR | FRST ADD | H | W | D |
|  | Mobile Laminate Glazed Privacy Panel | EVPPHGT6624M | 1312 | 168 | 66 | 24 | 2 7/8 |
| | | EVPPHGT6630M | 1445 | 192 | 66 | 30 | 2 7/8 |
| | | EVPPHGT6636M | 1619 | 229 | 66 | 36 | 2 7/8 |
| | | EVPPHGT6642M | 1748 | 255 | 66 | 42 | 2 7/8 |
| | | EVPPHGT6648M | 1885 | 281 | 66 | 48 | 2 7/8 |
| | | EVPPHGT6654M | 2040 | 313 | 66 | 54 | 2 7/8 |
| | | EVPPHGT6660M | 2220 | 348 | 66 | 60 | 2 7/8 |

EVPP - MOBILE LAMINATE GLAZED PRIVACY PANEL

- Includes panel with two connectors with T legs.
- 3" thick freestanding panels with 1" locking casters.
- 22" deep T-legs for stability (9.5" on each side)
- Laminate Base Module w/24" Tempered Glass above.
- Includes end of run trim.

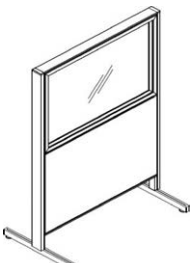
| | DESCRIPTION | PRODUCT CODE | LIST PRICE | | DIMENSIONS/INCHES | | |
|---|--------------------------------------|--------------|------------|----------|-------------------|----|-------|
| | | | CLR | FRST ADD | H | W | D |
|  | Mobile Laminate Glazed Privacy Panel | EVPPHGT5424M | 1073 | 128 | 54 | 24 | 2 7/8 |
| | | EVPPHGT5430M | 1184 | 150 | 54 | 30 | 2 7/8 |
| | | EVPPHGT5436M | 1297 | 171 | 54 | 36 | 2 7/8 |
| | | EVPPHGT5442M | 1412 | 196 | 54 | 42 | 2 7/8 |
| | | EVPPHGT5448M | 1523 | 217 | 54 | 48 | 2 7/8 |
| | | EVPPHGT5454M | 1641 | 240 | 54 | 54 | 2 7/8 |
| | | EVPPHGT5460M | 1746 | 261 | 54 | 60 | 2 7/8 |

EVPP - LAMINATE PRIVACY PANEL

- Includes panel with two connectors with T legs.
- 3" thick freestanding panels with leveling glides
- 22" deep T-legs for stability (9.5" on each side)
- All Modules are Laminate.
- Includes end of run trim.

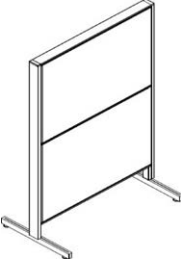
| DESCRIPTION | PRODUCT CODE | LIST PRICE | DIMENSIONS/INCHES | | |
|---|--------------|------------|-------------------|----|-------|
| | | | H | W | D |
|  Freestanding Laminate Privacy Panel | EVPPH2S5424 | 1058 | 54 | 24 | 2 7/8 |
| | EVPPH2S5430 | 1187 | 54 | 30 | 2 7/8 |
| | EVPPH2S5436 | 1324 | 54 | 36 | 2 7/8 |
| | EVPPH2S5442 | 1448 | 54 | 42 | 2 7/8 |
| | EVPPH2S5448 | 1570 | 54 | 48 | 2 7/8 |
| | EVPPH2S5454 | 1705 | 54 | 54 | 2 7/8 |
| | EVPPH2S5460 | 1826 | 54 | 60 | 2 7/8 |

EVPP - LAMINATE PRIVACY PANEL

- Includes panel with two connectors with T legs.
- 3" thick freestanding panels with leveling glides
- 22" deep T-legs for stability (9.5" on each side)
- All Modules are Laminate.
- Includes end of run trim.

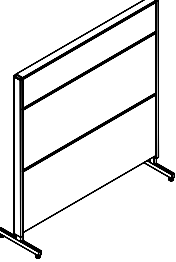
| DESCRIPTION | PRODUCT CODE | LIST PRICE | DIMENSIONS/INCHES | | |
|--|--------------|------------|-------------------|----|-------|
| | | | H | W | D |
|  Freestanding Laminate Privacy Panel | EVPPH2S6624 | 1281 | 66 | 24 | 2 7/8 |
| | EVPPH2S6630 | 1447 | 66 | 30 | 2 7/8 |
| | EVPPH2S6636 | 1637 | 66 | 36 | 2 7/8 |
| | EVPPH2S6642 | 1801 | 66 | 42 | 2 7/8 |
| | EVPPH2S6648 | 1960 | 66 | 48 | 2 7/8 |
| | EVPPH2S6654 | 2126 | 66 | 54 | 2 7/8 |
| | EVPPH2S6660 | 2301 | 66 | 60 | 2 7/8 |

EVPP - MOBILE LAMINATE PRIVACY PANEL

- Includes panel with two connectors with T legs.
- 3" thick freestanding panels with 1" locking casters.
- 22" deep T-legs for stability (9.5" on each side)
- All Modules are Laminate.
- Available in clear glass (CLR) and frosted glass (FRST)
- Includes end of run trim.

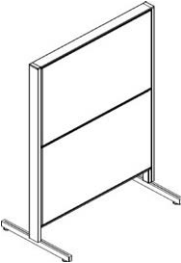
| DESCRIPTION | PRODUCT CODE | LIST PRICE | DIMENSIONS/INCHES | | |
|---|--------------|------------|-------------------|----|-------|
| | | | H | W | D |
|  Mobile Laminate Privacy Panel | EVPPH2S5424M | 1127 | 54 | 24 | 2 7/8 |
| | EVPPH2S5430M | 1257 | 54 | 30 | 2 7/8 |
| | EVPPH2S5436M | 1393 | 54 | 36 | 2 7/8 |
| | EVPPH2S5442M | 1520 | 54 | 42 | 2 7/8 |
| | EVPPH2S5448M | 1641 | 54 | 48 | 2 7/8 |
| | EVPPH2S5454M | 1775 | 54 | 54 | 2 7/8 |
| | EVPPH2S5460M | 1898 | 54 | 60 | 2 7/8 |



EVPP - MOBILE LAMINATE PRIVACY PANEL

- Includes panel with two connectors with T legs.
- 3" thick freestanding panels with 1" locking casters.
- 22" deep T-legs for stability (9.5" on each side)
- All Modules are Laminate.
- Includes end of run trim.

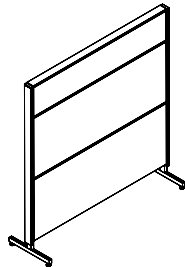

| DESCRIPTION | PRODUCT CODE | LIST PRICE | DIMENSIONS/INCHES | | |
|-------------------------------|--------------|------------|-------------------|----|-------|
| | | | H | W | D |
| Mobile Laminate Privacy Panel | EVPPH2S6624M | 1351 | 66 | 24 | 2 7/8 |
| | EVPPH2S6630M | 1518 | 66 | 30 | 2 7/8 |
| | EVPPH2S6636M | 1708 | 66 | 36 | 2 7/8 |
| | EVPPH2S6642M | 1872 | 66 | 42 | 2 7/8 |
| | EVPPH2S6648M | 2031 | 66 | 48 | 2 7/8 |
| | EVPPH2S6654M | 2196 | 66 | 54 | 2 7/8 |
| | EVPPH2S6660M | 2371 | 66 | 60 | 2 7/8 |

EVPP - FABRIC WRITE BOARD PRIVACY PANEL

- Includes panel with two connectors with T legs.
- 3" thick freestanding panels with leveling glides
- 22" deep T-legs for stability (9.5" on each side)
- Fabric Base Module with Write Board above.
- Includes end of run trim.

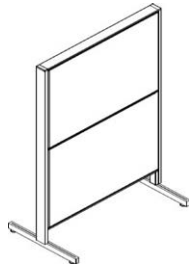

| DESCRIPTION | PRODUCT CODE | LIST PRICE | | DIMENSIONS/INCHES | | |
|--|--------------|------------|------|-------------------|----|-------|
| | | GR 1 | GR 2 | H | W | D |
| Freestanding Write Board Privacy Panel | EVPPF2W5424 | 1021 | 1040 | 54 | 24 | 2 7/8 |
| | EVPPF2W5430 | 1143 | 1164 | 54 | 30 | 2 7/8 |
| | EVPPF2W5436 | 1265 | 1295 | 54 | 36 | 2 7/8 |
| | EVPPF2W5442 | 1388 | 1418 | 54 | 42 | 2 7/8 |
| | EVPPF2W5448 | 1527 | 1564 | 54 | 48 | 2 7/8 |
| | EVPPF2W5454 | 1659 | 1699 | 54 | 54 | 2 7/8 |
| | EVPPF2W5460 | 1777 | 1823 | 54 | 60 | 2 7/8 |

EVPP - MOBILE FABRIC WRITE BOARD PRIVACY PANEL

- Includes panel with two connectors with T legs.
- 3" thick freestanding panels with 1" locking casters.
- 22" deep T-legs for stability (9.5" on each side)
- Fabric Base Module with Write Board above.
- Includes end of run trim.

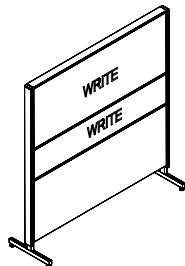

| DESCRIPTION | PRODUCT CODE | LIST PRICE | | DIMENSIONS/INCHES | | |
|---|--------------|------------|------|-------------------|----|-------|
| | | GR 1 | GR 2 | H | W | D |
| Mobile Write Board Glazed Privacy Panel | EVPPF2W6624M | 1304 | 1324 | 66 | 24 | 2 7/8 |
| | EVPPF2W6630M | 1516 | 1539 | 66 | 30 | 2 7/8 |
| | EVPPF2W6636M | 1701 | 1726 | 66 | 36 | 2 7/8 |
| | EVPPF2W6642M | 1869 | 1901 | 66 | 42 | 2 7/8 |
| | EVPPF2W6648M | 2054 | 2088 | 66 | 48 | 2 7/8 |
| | EVPPF2W6654M | 2226 | 2273 | 66 | 54 | 2 7/8 |
| | EVPPF2W6660M | 2440 | 2481 | 66 | 60 | 2 7/8 |

EVPP - MOBILE FABRIC WRITE BOARD PRIVACY PANEL

- Includes panel with two connectors with T legs.
- 3" thick freestanding panels with 1" locking casters.
- 22" deep T-legs for stability (9.5" on each side)
- Fabric Base Module with Write Board above.
- Includes end of run trim.

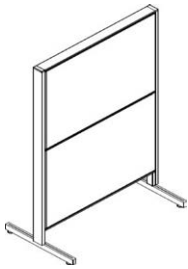
| DESCRIPTION | PRODUCT CODE | LIST PRICE | | DIMENSIONS/INCHES | | |
|---|--------------|------------|------|-------------------|----|-------|
| | | GR 1 | GR 2 | H | W | D |
|  <p>Mobile Write Board Privacy Panel</p> | EVPPF2W5424M | 1093 | 1110 | 54 | 24 | 2 7/8 |
| | EVPPF2W5430M | 1214 | 1237 | 54 | 30 | 2 7/8 |
| | EVPPF2W5436M | 1336 | 1366 | 54 | 36 | 2 7/8 |
| | EVPPF2W5442M | 1457 | 1489 | 54 | 42 | 2 7/8 |
| | EVPPF2W5448M | 1598 | 1632 | 54 | 48 | 2 7/8 |
| | EVPPF2W5454M | 1729 | 1768 | 54 | 54 | 2 7/8 |
| | EVPPF2W5460M | 1848 | 1895 | 54 | 60 | 2 7/8 |

EVPP - MOBILE LAMINATE WRITE BOARD PRIVACY PANEL

- Includes panel with two connectors with T legs.
- 3" thick freestanding panels with 1" locking casters.
- 22" deep T-legs for stability (9.5" on each side)
- Laminate Base Module with Write Board above.
- Includes end of run trim.

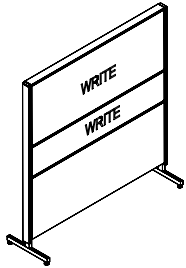
| DESCRIPTION | PRODUCT CODE | LIST PRICE | DIMENSIONS/INCHES | | |
|--|--------------|------------|-------------------|----|-------|
| | | | H | W | D |
|  <p>Mobile Write Board Laminated Privacy Panel</p> | EVPPH2W6624M | 1395 | 66 | 24 | 2 7/8 |
| | EVPPH2W6630M | 1639 | 66 | 30 | 2 7/8 |
| | EVPPH2W6636M | 1862 | 66 | 36 | 2 7/8 |
| | EVPPH2W6642M | 2044 | 66 | 42 | 2 7/8 |
| | EVPPH2W6648M | 2228 | 66 | 48 | 2 7/8 |
| | EVPPH2W6654M | 2420 | 66 | 54 | 2 7/8 |
| | EVPPH2W6660M | 2615 | 66 | 60 | 2 7/8 |

EVPP - LAMINATE WRITE BOARD PRIVACY PANEL

- Includes panel with two connectors with T legs.
- 3" thick freestanding panels with leveling glides
- 22" deep T-legs for stability (9.5" on each side)
- Laminate Base Module with Write Board above.
- Includes end of run trim.

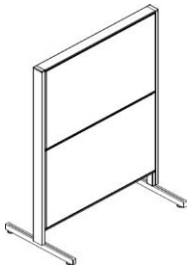
| DESCRIPTION | PRODUCT CODE | LIST PRICE | DIMENSIONS/INCHES | | |
|---|--------------|------------|-------------------|----|-------|
| | | | H | W | D |
|  <p>Freestanding Write Board Privacy Panel</p> | EVPPH2W5424 | 1121 | 54 | 24 | 2 7/8 |
| | EVPPH2W5430 | 1268 | 54 | 30 | 2 7/8 |
| | EVPPH2W5436 | 1422 | 54 | 36 | 2 7/8 |
| | EVPPH2W5442 | 1564 | 54 | 42 | 2 7/8 |
| | EVPPH2W5448 | 1701 | 54 | 48 | 2 7/8 |
| | EVPPH2W5454 | 1852 | 54 | 54 | 2 7/8 |
| | EVPPH2W5460 | 1989 | 54 | 60 | 2 7/8 |



EVPP - LAMINATE WRITE BOARD PRIVACY PANEL

- Includes panel with two connectors with T legs.
- 3" thick freestanding panels with leveling glides
- 22" deep T-legs for stability (9.5" on each side)
- Laminate Base Module with Write Board above
- Includes end of run trim.

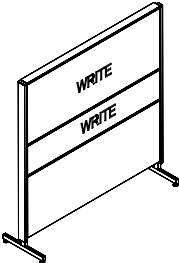
| DESCRIPTION | PRODUCT CODE | LIST PRICE | DIMENSIONS/INCHES | | |
|--|--------------|------------|-------------------|----|------|
| | | | H | W | D |
|  Freestanding Write Board Laminate Privacy Panel | EVPPH2W6624 | 1326 | 66 | 24 | 27/8 |
| | EVPPH2W6630 | 1569 | 66 | 30 | 27/8 |
| | EVPPH2W6636 | 1792 | 66 | 36 | 27/8 |
| | EVPPH2W6642 | 1973 | 66 | 42 | 27/8 |
| | EVPPH2W6648 | 2156 | 66 | 48 | 27/8 |
| | EVPPH2W6654 | 2349 | 66 | 54 | 27/8 |
| | EVPPH2W6660 | 2546 | 66 | 60 | 27/8 |

EVPP - MOBILE LAMINATE WRITE BOARD PRIVACY PANEL

- Includes panel with two connectors with T legs.
- 3" thick freestanding panels with 1" locking casters.
- 22" deep T-legs for stability (9.5" on each side)
- Laminate Base Module with Write Board above.
- Includes end of run trim.

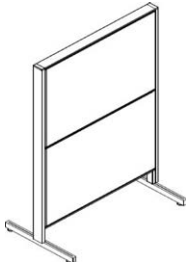
| DESCRIPTION | PRODUCT CODE | LIST PRICE | DIMENSIONS/INCHES | | |
|--|--------------|------------|-------------------|----|------|
| | | | H | W | D |
|  Mobile Write Board Privacy Panel | EVPPH2W5424M | 1193 | 54 | 24 | 27/8 |
| | EVPPH2W5430M | 1340 | 54 | 30 | 27/8 |
| | EVPPH2W5436M | 1490 | 54 | 36 | 27/8 |
| | EVPPH2W5442M | 1632 | 54 | 42 | 27/8 |
| | EVPPH2W5448M | 1771 | 54 | 48 | 27/8 |
| | EVPPH2W5454M | 1922 | 54 | 54 | 27/8 |
| | EVPPH2W5460M | 2060 | 54 | 60 | 27/8 |

EVPP - FABRIC WRITE BOARD PRIVACY PANEL

- Includes panel with two connectors with T legs.
- 3" thick freestanding panels with leveling glides
- 22" deep T-legs for stability (9.5" on each side)
- Fabric Base Module with Write Board above
- Includes end of run trim.

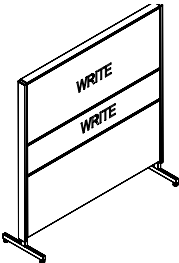
| DESCRIPTION | PRODUCT CODE | LIST PRICE | | DIMENSIONS/INCHES | | |
|--|--------------|------------|------|-------------------|----|------|
| | | GR 1 | GR 2 | H | W | D |
|  Freestanding Write Board Glazed Privacy Panel | EVPPF2W6624 | 1234 | 1252 | 66 | 24 | 27/8 |
| | EVPPF2W6630 | 1446 | 1469 | 66 | 30 | 27/8 |
| | EVPPF2W6636 | 1630 | 1657 | 66 | 36 | 27/8 |
| | EVPPF2W6642 | 1799 | 1831 | 66 | 42 | 27/8 |
| | EVPPF2W6648 | 1985 | 2017 | 66 | 48 | 27/8 |
| | EVPPF2W6654 | 2154 | 2203 | 66 | 54 | 27/8 |
| | EVPPF2W6660 | 2370 | 2412 | 66 | 60 | 27/8 |

panel connectors



Slotted posts are included with each Variable-Height Corner Post. The height of each slotted post must be specified when ordering a Variable-Height Corner Post. Slotted post height is determined by the height of the connecting panel run.

Example

Step 1 Specify base code listed on pricing page.

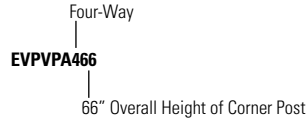

Segmented Panel

Step 2 Specify slotted post heights.

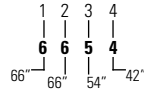

Note: To specify height, use the first number of the connecting panel run height dimension.

Slotted Post Positions

As illustrated in the example below, start with position 1 and continue clockwise specifying the height of each slotted post.

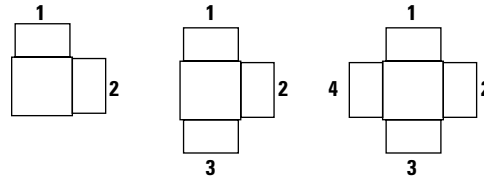

Sample Configuration - EVPVPA466-6654

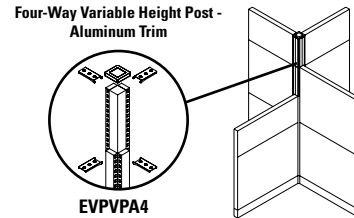

PANEL CONNECTORS BY TYPE

Inline Connector 121-123

- Inline Connector
- Inline Connector for Light Panels
- Inline Connector for Beltline Powered Panels
- Inline Connector for Beltline Powered Light Panels
- Inline Variable - Height Connector
- Inline Variable - Height Connector for Light Panels
- Inline Variable - Height Connector for Beltline Powered Panels
- Inline Variable - Height Connector for Beltline Powered Light Panels

End-of-Run 124

- End-of-Run Post Kit (Wall Mountable) - Aluminum Trim
- End-of-Run Post Kit for Light Panels (Wall Mountable) - Aluminum Trim

Two-Way Post 125-128

- Two-Way Post - Aluminum Trim
- Two-Way Post for Light Panels - Aluminum Trim
- Two-Way Post for Beltline Powered Panels - Aluminum Trim
- Two-Way Post for Beltline Powered Light Panels - Aluminum Trim
- Two-Way Variable - Height Post - Aluminum Trim
- Two-Way Variable - Height Post for Light Panels - Aluminum Trim
- Two-Way Variable - Height Post for Beltline Powered Panels - Aluminum Trim
- Two-Way Variable - Height Post for Beltline Powered Light Panels - Aluminum Trim

Three-Way Post 129-132

- Three-Way Post - Aluminum Trim
- Three-Way Post for Light Panels - Aluminum Trim
- Three-Way Post for Beltline Powered Panels - Aluminum Trim
- Three-Way Post for Beltline Powered Light Panels - Aluminum Trim
- Three-Way Variable - Height Post - Aluminum Trim
- Three-Way Variable - Height Post for Light Panels - Aluminum Trim
- Three-Way Variable - Height Post for Beltline Powered Panels - Aluminum Trim
- Three-Way Variable - Height Post for Beltline Powered Light Panels - Aluminum Trim

Four-Way Post 133-136

- Four-Way Post
- Four-Way Post for Light Panels
- Four-Way Post for Beltline Powered Panels
- Four-Way Post for Beltline Powered Light Panels
- Four-Way Variable - Height Post - Aluminum Trim
- Four-Way Variable - Height Post for Light Panels - Aluminum Trim
- Four-Way Variable - Height Post for Beltline Powered Panels - Aluminum Trim
- Four-Way Variable - Height Post for Beltline Powered Light Panels - Aluminum Trim

One-Way Post 137-138

- One-Way Post - Aluminum Trim
- One-Way Post for Light Panels - Aluminum Trim
- One-Way Post for Beltline Powered Panels - Aluminum Trim
- One-Way Post for Beltline Powered Light Panels - Aluminum Trim

Inline Two-Way Post 139-140

- Inline Two-Way Post - Aluminum Trim
- Inline Two-Way Post for Light Panels - Aluminum Trim
- Inline Two-Way Post for Beltline Powered Panels - Aluminum Trim
- Inline Two-Way Post for Beltline Powered Light Panels - Aluminum Trim

60 Degree 141-143

- Two-Way 60 Degree Post - Aluminum Trim
- Two-Way 60 Degree Post for Beltline Powered Panels - Aluminum Trim
- Two-Way 60 Degree Variable - Height Post - Aluminum Trim
- Two-Way 60 Degree Variable - Height Post for Beltline Powered Panels - Aluminum Trim
- Three-Way 60 Degree Post
- Three-Way 60 Degree Post for Beltline Powered Panels
- Three-Way 60 Degree Variable - Height Post - Aluminum Trim
- Three-Way 60 Degree Variable - Height Post for Beltline Powered Panels - Aluminum Trim

45 Degree 143-144

- Two-Way 45 Degree Post
- Two-Way 45 Degree Variable - Height Post

Upmount End of Run 144-145

- Upmount End-of-Run Post Kit (Wall Mountable) - Aluminum
- Upmount End-of-Run Post Kit For Light Panels (Wall Mountable) - Aluminum
- Upmount End-of-Run Trim - Aluminum
- Upmount End-of-Run Trim for Light Panels - Aluminum

Extension 146-149

- Inline Extension Connector - Slotted
- End-of-Run Extension Connector - Slotted - Aluminum
- Two-Way Post Extension - Slotted - Aluminum
- Three-Way Post Extension - Slotted - Aluminum
- Four-Way Post Extension - Slotted
- One-Way Post Extension - Slotted - Aluminum
- Inline Two-Way Post Extension - Slotted - Aluminum
- Two-Way 60 Degree Post Extension - Slotted - Aluminum
- Three Way 60 Degree Post Extension - Slotted - Aluminum
- One-Way 60 Degree Post Extension - Slotted - Aluminum
- Two-Way 45 Degree Post Extension - Slotted - Aluminum
- One-Way 45 Degree Post Extension - Slotted - Aluminum

Trims 150-153

- Upmount Extension Trim - Aluminum
- End-of-Run Trim - Aluminum
- End-of-Run Trim for Light Panels - Aluminum
- Panel Trim Variable Height - Aluminum
- Panel Extension Trim - Aluminum
- Flat Trim - Aluminum
- Flat Trim for Light Panels - Aluminum
- Flat Extension Trim - Aluminum
- Panel Top Trim - Aluminum
- Panel Top Single Notched Trim - Aluminum
- Panel Top Double Notched Trim - Aluminum
- Slot Cover



EVPIC - INLINE CONNECTOR

- Connects two panels of equal height in a straight run.
- Provides slotted support for worksurfaces and hang-on storage components.
- Includes one slotted connector with leveling glide and connecting hardware.
- Connectors available without slots, as a special at no upcharge. Contact Customer Support.

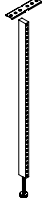
| DESCRIPTION | PRODUCT CODE | LIST PRICE | DIMENSIONS/INCHES | | |
|---|--------------|------------|-------------------|---|---|
| | | | H | W | D |
|  <p>Inline Connector</p> | EVPLIC30 | 74 | 30 | 2 | |
| | EVPLIC42 | 86 | 42 | 2 | |
| | EVPLIC48 | 90 | 48 | 2 | |
| | EVPLIC54 | 92 | 54 | 2 | |
| | EVPLIC66 | 102 | 60 | 2 | |

EVPLTIC - LIGHT PANEL INLINE CONNECTOR LEG WITH TRIMS

- Connects two Light panel in straight run.
- Provides slotted support for worksurfaces and hang on components.
- Includes one slotted connector with leveling glide with leg and trims and connecting hardware.
- Connectors available without slots, as a special at no extra charge. Contact customer support.

| DESCRIPTION | PRODUCT CODE | LIST PRICE | DIMENSIONS/INCHES | | |
|---|--------------|------------|-------------------|---|---|
| | | | H | W | D |
|  <p>Light Panel Inline Connector Leg with Trims</p> | EVPLTIC30 | 74 | 30 | 2 | |
| | EVPLTIC42 | 86 | 42 | 2 | |
| | EVPLTIC48 | 90 | 48 | 2 | |
| | EVPLTIC54 | 92 | 54 | 2 | |
| | EVPLTIC66 | 102 | 66 | 2 | |

EVPBIC - INLINE CONNECTOR FOR BELTLINE POWERED PANELS

- Connects two Beltline Powered panels of equal height in a straight run.
- Provides slotted support for worksurfaces and hang-on storage components.
- Includes one slotted connector with leveling glide and connecting hardware.
- Connectors available without slots, as a special at no upcharge. Contact Customer Support.

| DESCRIPTION | PRODUCT CODE | LIST PRICE | DIMENSIONS/INCHES | | |
|---|--------------|------------|-------------------|---|---|
| | | | H | W | D |
|  <p>Inline Connector for Beltline Powered Panels</p> | EVPBIC42 | 86 | 42 | 2 | |
| | EVPBIC54 | 92 | 54 | 2 | |
| | EVPBIC66 | 102 | 66 | 2 | |

EVPBLTIC - BELTLINE LIGHT PANEL INLINE CONNECTOR LEG WITH TRIMS

- Connects two Light panel in straight run.
- Provides slotted support for worksurfaces and hang on components.
- Includes one slotted connector with leveling glide with leg and trims and connecting hardware.
- Connectors available without slots, as a special at no extra charge. Contact customer support.

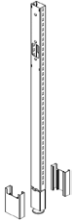
| DESCRIPTION | PRODUCT CODE | LIST PRICE | DIMENSIONS/INCHES | | |
|---|--------------|------------|-------------------|---|---|
| | | | H | W | D |
|  Beltline Light Panel Inline Connector Leg with trims | EVPBLTIC42 | 86 | 42 | 2 | |
| | EVPBLTIC54 | 92 | 54 | 2 | |
| | EVPBLTIC66 | 102 | 66 | 2 | |

EVPVC - INLINE VARIABLE - HEIGHT CONNECTOR

- Connects two panels of differing height in a straight run.
- Connector must reference taller panel.
- Can be used for any variation of panel heights.
- Variable-height trim must be ordered separately (see EVPTVAXX)
- Provides slotted support for worksurfaces and hang-on storage components.
- Includes one slotted connector with leveling glide and connecting hardware.
- Connectors available without slots, as a special at no upcharge. Contact Customer Support.
- Please see page 92 on how to specify.

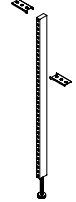
| DESCRIPTION | PRODUCT CODE | LIST PRICE | DIMENSIONS/INCHES | | |
|---|--------------|------------|-------------------|---|---|
| | | | H | W | D |
|  Inline Variable - Height Connector | EVPVC42 | 92 | 42 | 2 | |
| | EVPVC48 | 94 | 48 | 2 | |
| | EVPVC54 | 95 | 54 | 2 | |
| | EVPVC66 | 104 | 66 | 2 | |

EVPLTVC - INLINE VARIABLE HEIGHT CONNECTOR WITH LEG WITH TRIMS

- Connects two Light panels of differing height in straight run.
- Connector must reference taller panel.
- Can be used for any variation of panel height.
- Variable height trim must be ordered separately (see EVPTVAXX).
- Provides slotted support for worksurfaces and hang on components.
- Includes one slotted connector with leveling glide with leg and trims and connecting hardware.
- Connectors available without slots, as a special at no extra charge. Contact customer support.

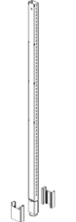
| DESCRIPTION | PRODUCT CODE | LIST PRICE | DIMENSIONS/INCHES | | |
|---|--------------|------------|-------------------|---|---|
| | | | H | W | D |
|  Inline Variable Height Connector with Leg with Trims | EVPLTVC42 | 92 | 42 | 2 | |
| | EVPLTVC48 | 94 | 48 | 2 | |
| | EVPLTVC54 | 95 | 54 | 2 | |
| | EVPLTVC66 | 104 | 66 | 2 | |



EVPBVC - INLINE VARIABLE - HEIGHT CONNECTOR FOR BELTLINE POWERED PANELS

- Connects two Beltline Powered panels of differing height in a straight run.
- Connector must reference taller panel.
- Can be used for any variation of panel heights.
- Variable-height trim must be ordered separately (see EVPTVAXX)
- Provides slotted support for worksurfaces and hang-on storage components.
- Includes one slotted connector with leveling glide and connecting hardware.
- Connectors available without slots, as a special at no upcharge. Contact Customer Support.
- Please see page 92 on how to specify.

| | DESCRIPTION | PRODUCT CODE | LIST PRICE | DIMENSIONS/INCHES | | |
|---|--|--------------|------------|-------------------|---|---|
| | | | | H | W | D |
|  | Inline Variable - Height Connector for Beltline Powered Panels | EVPBVC54 | 95 | 54 | 2 | |
| | | EVPBVC66 | 104 | 66 | 2 | |

EVPBLTVC - INLINE VARIABLE HEIGHT CONNECTOR FOR BELTLINE LIGHT PANEL

- Connects two Light panels of differing height in straight run.
- Connector must reference taller panel.
- Can be used for any variation of panel height.
- Variable height trim must be ordered separately (see EVPTVAXX)
- Provides slotted support for worksurfaces and hang on components.
- Includes one slotted connector with leveling glide with leg and trims and connecting hardware.
- Includes one slotted connector with leveling glide with leg and trims and connecting hardware.

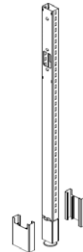
| | DESCRIPTION | PRODUCT CODE | LIST PRICE | DIMENSIONS/INCHES | | |
|--|----------------------------------|--------------|------------|-------------------|---|---|
| | | | | H | W | D |
|  | Inline Variable Height Connector | EVPBLTVC54 | 95 | 54 | 2 | |
| | | EVPBLTVC66 | 104 | 60 | 2 | |

EVPERA - END-OF-RUN POST KIT (WALL MOUNTABLE) - ALUMINUM TRIM

- Connects at the end of a panel run and can be used to attach a panel to a fixed wall.
- Adds 1" to the width of the panel run.
- Provides slotted support for worksurfaces and hang-on storage components.
- Includes one slotted connector with leveling glide, connecting hardware and trim kit.
- Can be attached to face of another panel to provide off-modular panel connection.
- Connectors available without slots, as a special at no upcharge. Contact Customer Support.

| | DESCRIPTION | PRODUCT CODE | LIST PRICE | DIMENSIONS/INCHES | | |
|---|--|--------------|------------|-------------------|-------|---|
| | | | | H | W | D |
|  | End-of-Run Post Kit (Wall Mountable) - | EVPERA30 | 90 | 30 | 2 7/8 | |
| | Aluminum Trim | EVPERA42 | 102 | 42 | 2 7/8 | |
| | | EVPERA48 | 109 | 48 | 2 7/8 | |
| | | EVPERA54 | 123 | 54 | 2 7/8 | |
| | | EVPERA66 | 136 | 66 | 2 7/8 | |

EVPLTERA - END OF RUN POST KIT FOR LIGHT PANEL

- Connects at end of Light panel and can attach to a panel to fixed wall.
- Adds 1" to width of panel run.
- Provides slotted support for worksurfaces and hang on components.
- Includes one slotted connector with leveling glide with leg and trims and connecting hardware.
- Can be attached to face of another panel to provide off modular connection.
- Connectors available without slots, as a special at no extra charge. Contact customer support.

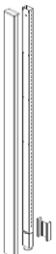
| | DESCRIPTION | PRODUCT CODE | LIST PRICE | DIMENSIONS/INCHES | | |
|--|-------------------------------------|--------------|------------|-------------------|---|---|
| | | | | H | W | D |
|  | End of run post kit for Light Panel | EVPLTERA30 | 90 | 30 | 2 | |
| | | EVPLTERA42 | 102 | 42 | 2 | |
| | | EVPLTERA48 | 109 | 48 | 2 | |
| | | EVPLTERA54 | 123 | 54 | 2 | |
| | | EVPLTERA66 | 136 | 66 | 2 | |



EVPCPA2 - TWO-WAY POST - ALUMINUM TRIM

- Connects two panels of equal height in a 90 degree configuration.
- Post and connecting hardware adds 3.25" to the panel run.
- Provides slotted support for worksurfaces and hang-on storage components.
- Includes one post, two slotted connectors with leveling glides, connecting hardware and trim kit.
- Connectors available without slots, as a special at no upcharge. Contact Customer Support.

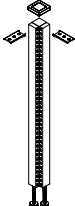
| DESCRIPTION | PRODUCT CODE | LIST PRICE | DIMENSIONS/INCHES | | |
|---|--------------|------------|-------------------|-------|---|
| | | | H | W | D |
|  <p>Two-Way Post - Aluminum Trim</p> | EVPCPA230 | 168 | 30 | 2 7/8 | |
| | EVPCPA242 | 209 | 42 | 2 7/8 | |
| | EVPCPA248 | 223 | 48 | 2 7/8 | |
| | EVPCPA254 | 259 | 54 | 2 7/8 | |
| | EVPCPA266 | 304 | 66 | 2 7/8 | |

EVPLTCPA2 - TWO WAY CORNER POST FOR LIGHT PANEL

- Connects two Light panel of equal height in 90 degree configuration.
- Post and connecting hardware add 3.25" to power beam run.
- Provides slotted support for worksurfaces and hang on components.
- Includes post, panel connectors and power beam connectors, post with trim all around, levelling glide, hardware and trim kit.
- Leg trim matches selected trim color.
- Connectors available without slots, as a special at no extra charge. Contact customer support.

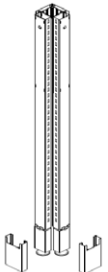
| DESCRIPTION | PRODUCT CODE | LIST PRICE | DIMENSIONS/INCHES | | |
|---|--------------|------------|-------------------|-------|---|
| | | | H | W | D |
|  <p>Two Way Corner Post for Light Panel</p> | EVPLTCPA230 | 168 | 30 | 2 7/8 | |
| | EVPLTCPA242 | 209 | 42 | 2 7/8 | |
| | EVPLTCPA248 | 223 | 48 | 2 7/8 | |
| | EVPLTCPA254 | 259 | 54 | 2 7/8 | |
| | EVPLTCPA266 | 304 | 66 | 2 7/8 | |

EVPLTCPA2P- TWO WAY CORNER POST FOR LIGHT PANEL

- Connects Light panel and Panel of equal height in 90 degree configuration.
- Post and connecting hardware add 3.25" to power beam run.
- Provides slotted support for worksurfaces and hang on components.
- Includes post, panel connectors and power beam connectors, post with trim all around, levelling glide, hardware and trim kit.
- Leg trim matches selected trim color.
- Connectors are available without slots, as a special at no extra charge. Contact customer support.

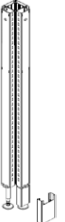
| DESCRIPTION | PRODUCT CODE | LIST PRICE | DIMENSIONS/INCHES | | |
|--|--------------|------------|-------------------|-------|---|
| | | | H | W | D |
|  <p>Two Way Corner Post for Light Panel</p> | EVPLTCPA230P | 168 | 30 | 2 7/8 | |
| | EVPLTCPA242P | 209 | 42 | 2 7/8 | |
| | EVPLTCPA248P | 223 | 48 | 2 7/8 | |
| | EVPLTCPA254P | 259 | 54 | 2 7/8 | |
| | EVPLTCPA266P | 304 | 66 | 2 7/8 | |

EVPBCPA2 - TWO-WAY POST FOR BELTLINE POWERED PANELS - ALUMINUM TRIM

- Connects two Beltline Powered panels of equal height in a 90 degree configuration.
- Post and connecting hardware adds 3.25" to the panel run.
- Provides slotted support for worksurfaces and hang-on storage components.
- Includes one post, two slotted connectors with leveling glides, connecting hardware and trim kit.
- Connectors available without slots, as a special at no upcharge. Contact Customer Support.

| DESCRIPTION | PRODUCT CODE | LIST PRICE | DIMENSIONS/INCHES | | |
|--|--------------|------------|-------------------|-------|---|
| | | | H | W | D |
| Two-Way Post for Beltline Powered Panels - Aluminum Trim | EVPBCPA242 | 209 | 42 | 2 7/8 | |
| | EVPBCPA254 | 259 | 54 | 2 7/8 | |
| | EVPBCPA266 | 304 | 66 | 2 7/8 | |

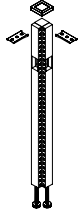

EVPBLTCPA2 - TWO WAY CORNER POST FOR BELTLINE LIGHT PANEL

- Connects two Light panel of equal height in 90 degree configuration.
- Post and connecting hardware add 3.25" to power beam run.
- Provides slotted support for worksurfaces and hang on components.
- Includes post, panel connectors and power beam connectors, post with trim all around, levelling glide, hardware and trim kit.
- Leg trim matches selected trim color.
- Connectors available without slots, as a special at no extra charge. Contact customer support.

| DESCRIPTION | PRODUCT CODE | LIST PRICE | DIMENSIONS/INCHES | | |
|--|--------------|------------|-------------------|---|---|
| | | | H | W | D |
| Two Way Corner Post for Beltline Light Panel | EVPBLTCPA242 | 209 | 42 | 2 | |
| | EVPBLTCPA248 | 223 | 48 | 2 | |
| | EVPBLTCPA254 | 259 | 54 | 2 | |
| | EVPBLTCPA266 | 304 | 66 | 2 | |

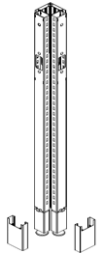

EVPBLTCPA2P - TWO WAY CORNER POST FOR BELTLINE LIGHT PANEL

- Connects Beltline Light panel and Beltline Panel of equal height in 90 degree configuration.
- Post and connecting hardware add 3.25" to power beam run.
- Provides slotted support for worksurfaces and hang on components.
- Includes post, panel connectors and power beam connectors, post with trim all around, levelling glide, hardware and trim kit.
- Leg trim matches selected trim color.
- Connectors are available without slots, as a special at no extra charge. Contact customer support.

| DESCRIPTION | PRODUCT CODE | LIST PRICE | DIMENSIONS/INCHES | | |
|--|---------------|------------|-------------------|-------|---|
| | | | H | W | D |
| Two Way Corner Post for Beltline Light Panel | EVPBLTCPA242P | 209 | 42 | 2 7/8 | |
| | EVPBLTCPA248P | 223 | 48 | 2 7/8 | |
| | EVPBLTCPA254P | 259 | 54 | 2 7/8 | |
| | EVPBLTCPA266P | 304 | 66 | 2 7/8 | |

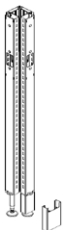

EVPVPA2 - TWO-WAY VARIABLE - HEIGHT POST - ALUMINIM TRIM

- Connects two panels of differing height in a 90 degree configuration.
- Connector must reference taller panel.
- Post and connecting hardware adds 3.25" to the panel run.
- Provides slotted support for worksurfaces and hang-on storage components.
- Includes one post, two slotted connectors with leveling glides, connecting hardware and trim kit.
- Connectors available without slots as a special at no upcharge. Contact Customer Support
- Please see page 92 on how to specify.

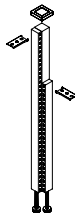
| DESCRIPTION | PRODUCT CODE | LIST PRICE | DIMENSIONS/INCHES | | |
|--|--------------|------------|-------------------|-------|---|
| | | | H | W | D |
|  Two-Way Variable - Height Post - Aluminum Trim | EVPVPA242 | 209 | 42 | 2 7/8 | |
| | EVPVPA248 | 233 | 48 | 2 7/8 | |
| | EVPVPA254 | 259 | 54 | 2 7/8 | |
| | EVPVPA266 | 304 | 66 | 2 7/8 | |

EVPLTVPA2 - TWO WAY VARIABLE HEIGHT CORNER POST FOR LIGHT PANEL

- Connects two Light panel of differing height in 90 degree configuration.
- Connector must reference taller panel.
- Post and connecting hardware add 3.25" to power beam run.
- Provides slotted support for worksurfaces and hang on components.
- Includes post, panel connectors and power beam connectors, post with trim all around, levelling glide, hardware and trim kit.
- Leg trim matches selected trim color.
- Connectors available without slots, as a special at no extra charge. Contact customer support.

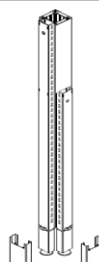
| DESCRIPTION | PRODUCT CODE | LIST PRICE | DIMENSIONS/INCHES | | |
|---|--------------|------------|-------------------|-------|---|
| | | | H | W | D |
|  Two Way Variable Height Corner Post for Beltline Light Panel | EVPLTVPA242 | 209 | 42 | 2 7/8 | |
| | EVPLTVPA248 | 223 | 48 | 2 7/8 | |
| | EVPLTVPA254 | 259 | 54 | 2 7/8 | |
| | EVPLTVPA266 | 304 | 66 | 2 7/8 | |

EVPLTVPA2P- TWO WAY VARIABLE HEIGHT CORNER POST FOR LIGHT PANEL - PANEL

- Connects Light panel and Panel of differing height in 90 degree configuration.
- Connector must reference taller panel.
- Post and connecting hardware add 3.25" to power beam run.
- Provides slotted support for worksurfaces and hang on components.
- Includes post, panel connectors and power beam connectors, post with trim all around, levelling glide, hardware and trim kit.
- Leg trim matches selected trim color.
- Connectors are available without slots, as a special at no extra charge. Contact customer support.

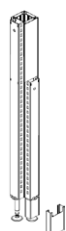
| DESCRIPTION | PRODUCT CODE | LIST PRICE | DIMENSIONS/INCHES | | |
|---|--------------|------------|-------------------|-------|---|
| | | | H | W | D |
|  Two Way Variable Height Corner Post for Light Panel-Panel | EVPLTVPA242P | 209 | 42 | 2 7/8 | |
| | EVPLTVPA248P | 223 | 48 | 2 7/8 | |
| | EVPLTVPA254P | 259 | 54 | 2 7/8 | |
| | EVPLTVPA266P | 304 | 66 | 2 7/8 | |

EVPBVPA2 - TWO-WAY VARIABLE - HEIGHT POST FOR BELTLINE POWERED PANELS - ALUMINIM TRIM

- Connects two Beltline Powered panels of differing height in a 90 degree configuration.
- Connector must reference taller panel.
- Post and connecting hardware adds 3.25" to the panel run.
- Provides slotted support for worksurfaces and hang-on storage components.
- Includes one post, two slotted connectors with leveling glides, connecting hardware and trim kit.
- Connectors available without slots, as a special at no upcharge. Contact Customer Support.

| DESCRIPTION | PRODUCT CODE | LIST PRICE | DIMENSIONS/INCHES | | |
|-------------|--------------|------------|-------------------|---|---|
| | | | H | W | D |

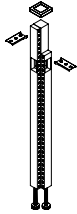

Two-Way Variable - Height Post for Beltline Powered Panels - Aluminum Trim

EVPBVPA254
EVPBVPA266

259
304

54 2 7/8
66 2 7/8

EVPBLTVA2 - TWO WAY VARIABLE HEIGHT CORNER POST FOR BELTLINE LIGHT PANEL

- Connects two Light panel of differing height in 90 degree configuration.
- Connector must reference taller panel.
- Post and connecting hardware add 3.25" to power beam run.
- Provides slotted support for worksurfaces and hang on components.
- Leg trim matches selected trim color.
- Includes post, panel connectors and power beam connectors, post with trim all around, levelling glide, hardware and trim kit.
- Connectors available without slots, as a special at no extra charge. Contact customer support.

| DESCRIPTION | PRODUCT CODE | LIST PRICE | DIMENSIONS/INCHES | | |
|-------------|--------------|------------|-------------------|---|---|
| | | | H | W | D |



Two Way Variable Height Corner Post for Beltline Light Panel

EVPBLTVA254
EVPBLTVA266

259
304

54 2 7/8
66 2 7/8

EVPBLTVA2P - TWO WAY VARIABLE HEIGHT CORNER POST FOR BELTLINE LIGHT PANEL

- Connects Beltline Light panel and Beltline Panel of differing height in 90 degree configuration.
- Connector must reference taller panel.
- Post and connecting hardware add 3.25" to power beam run.
- Provides slotted support for worksurfaces and hang on components.
- Includes post, panel connectors and power beam connectors, post with trim all around, levelling glide, hardware and trim kit.
- Leg trim matches selected trim color.
- Connectors are available without slots, as a special at no extra charge. Contact customer support.

| DESCRIPTION | PRODUCT CODE | LIST PRICE | DIMENSIONS/INCHES | | |
|-------------|--------------|------------|-------------------|---|---|
| | | | H | W | D |

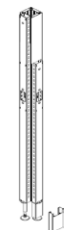

Two Way Variable Height Corner Post for Beltline Light Panel

EVPBLTVA254P
EVPBLTVA266P

335
304

54 2 7/8
66 2 7/8



EVPCPA3 - THREE-WAY POST - ALUMINUM TRIM

- Connects three panels of equal height in a "T" configuration.
- Post and connecting hardware adds 3.25" to the panel run.
- Provides slotted support for worksurfaces and hang-on storage components.
- Includes one post, three slotted connectors with leveling glides, connecting hardware and trim kit.
- Connectors available without slots, as a special at no upcharge. Contact Customer Support.

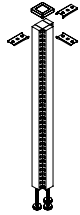

| DESCRIPTION | PRODUCT CODE | LIST PRICE | DIMENSIONS/INCHES | | |
|--------------------------------|--------------|------------|-------------------|-------|---|
| | | | H | W | D |
| Three-Way Post - Aluminum Trim | EVPCPA330 | 207 | 30 | 2 7/8 | |
| | EVPCPA342 | 277 | 42 | 2 7/8 | |
| | EVPCPA348 | 304 | 48 | 2 7/8 | |
| | EVPCPA354 | 335 | 54 | 2 7/8 | |
| | EVPCPA366 | 395 | 66 | 2 7/8 | |

EVPLTCPA3 - THREE WAY CORNER POST FOR LIGHT PANEL

- Connects three Light panel of equal height in "T" configuration.
- Post and connecting hardware add 3.25" to power beam run.
- Provides slotted support for worksurfaces and hang on components.
- Includes post, panel connectors and power beam connectors, post with trim all around, levelling glide, hardware and trim kit.
- Leg trim matches selected trim color.
- Connectors available without slots, as a special at no extra charge. Contact customer support.



| DESCRIPTION | PRODUCT CODE | LIST PRICE | DIMENSIONS/INCHES | | |
|---------------------------------------|--------------|------------|-------------------|-------|---|
| | | | H | W | D |
| Three Way Corner Post for Light Panel | EVPLTCPA330 | 207 | 30 | 2 7/8 | |
| | EVPLTCPA342 | 277 | 42 | 2 7/8 | |
| | EVPLTCPA348 | 304 | 48 | 2 7/8 | |
| | EVPLTCPA354 | 335 | 54 | 2 7/8 | |
| | EVPLTCPA366 | 395 | 66 | 2 7/8 | |

EVPLTCPA3P - THREE WAY CORNER POST FOR PANEL - LIGHT PANEL

- Connects one Light panel and two Panels of equal height in "T" configuration, Panel-Light Panel-Panel.
- Post and connecting hardware add 3.25" to power beam run.
- Provides slotted support for worksurfaces and hang on components.
- Includes post, panel connectors and power beam connectors, post with trim all around, levelling glide, hardware and trim kit.
- Leg trim matches selected trim color.
- Connectors are available without slots, as a special at no extra charge. Contact customer support.

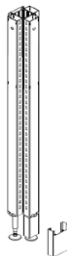

| DESCRIPTION | PRODUCT CODE | LIST PRICE | DIMENSIONS/INCHES | | |
|---|--------------|------------|-------------------|-------|---|
| | | | H | W | D |
| Three Way Corner Post for Panel-Light Panel | EVPLTCPA330P | 207 | 30 | 2 7/8 | |
| | EVPLTCPA342P | 277 | 42 | 2 7/8 | |
| | EVPLTCPA348P | 304 | 48 | 2 7/8 | |
| | EVPLTCPA354P | 335 | 54 | 2 7/8 | |
| | EVPLTCPA366P | 395 | 66 | 2 7/8 | |

EVPLTCPA3PT - THREE WAY CORNER POST FOR LIGHT PANEL -PANEL-LIGHT PANEL

- Connects one Light panel and two Panels of equal height in "T" configuration , Light Panel-Panel-Light Panel.
- Post and connecting hardware add 3.25" to Power Beam run.
- Provides slotted support for worksurfaces and hang on components.
- Includes post, panel connectors and power beam connectors, post with trim all around, leveling glide, hardware and trim kit.
- Leg trim matches selected trim color.
- Connectors available without slots, as a special at no upcharge. Contact Customer Support.

| DESCRIPTION | PRODUCT CODE | LIST PRICE | DIMENSIONS/INCHES | | |
|---|---------------|------------|-------------------|-------|---|
| | | | H | W | D |
|  Three-Way Corner Post Light Panel-Panel-Light Panel | EVPLTCPA330PT | 207 | 30 | 2 7/8 | |
| | EVPLTCPA342PT | 277 | 42 | 2 7/8 | |
| | EVPLTCPA348PT | 304 | 48 | 2 7/8 | |
| | EVPLTCPA354PT | 335 | 54 | 2 7/8 | |
| | EVPLTCPA366PT | 395 | 66 | 2 7/8 | |

EVPBCPA3 - THREE-WAY POST FOR BELTLINE POWERED PANELS - ALUMINUM TRIM

- Connects three Beltline Powered panels of equal height in a "T" configuration.
- Post and connecting hardware adds 3.25" to the panel run.
- Provides slotted support for worksurfaces and hang-on storage components.
- Includes one post, three slotted connectors with leveling glides, connecting hardware and trim kit.
- Connectors available without slots, as a special at no upcharge. Contact Customer Support.

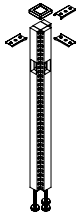
| DESCRIPTION | PRODUCT CODE | LIST PRICE | DIMENSIONS/INCHES | | |
|---|--------------|------------|-------------------|-------|---|
| | | | H | W | D |
|  Three-Way Post for Beltline Powered Panels - Aluminum Trim | EVPBCPA342 | 277 | 42 | 2 7/8 | |
| | EVPBCPA354 | 335 | 54 | 2 7/8 | |
| | EVPBCPA366 | 395 | 66 | 2 7/8 | |

EVPLTCPA3 - THREE WAY CORNER POST FOR BELTLINE LIGHT PANEL

- Connects three Light panel of equal height in "T" configuration.
- Post and connecting hardware add 3.25" to power beam run.
- Provides slotted support for worksurfaces and hang on components.
- Includes post, panel connectors and power beam connectors, post with trim all around, levelling glide, hardware and trim kit.
- Leg trim matches selected trim color.
- Connectors available without slots, as a special at no extra charge. Contact customer support.

| DESCRIPTION | PRODUCT CODE | LIST PRICE | DIMENSIONS/INCHES | | |
|---|--------------|------------|-------------------|---|---|
| | | | H | W | D |
|  Three Way Corner Post for Beltline Light Panel | EVPLTCPA342 | 277 | 42 | 2 | |
| | EVPLTCPA348 | 304 | 48 | 2 | |
| | EVPLTCPA354 | 335 | 54 | 2 | |
| | EVPLTCPA366 | 395 | 66 | 2 | |



EVPBLTCPA3P - THREE WAY CORNER POST FOR BELTLINE LIGHT PANEL

- Connects one Beltline Light panel and two Beltline panels of equal height in "T" configuration.
- Post and connecting hardware add 3.25" to power beam run.
- Provides slotted support for worksurfaces and hang on components.
- Includes post, panel connectors and power beam connectors, post with trim all around, levelling glide, hardware and trim kit.
- Leg trim matches selected trim color.
- Connectors are available without slots, as a special at no extra charge. Contact customer support.

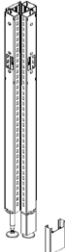
| DESCRIPTION | PRODUCT CODE | LIST PRICE | DIMENSIONS/INCHES | | |
|---|---------------|------------|-------------------|-------|---|
| | | | H | W | D |
|  Three way Corner Post Light Panel | EVPBLTCPA342P | 277 | 42 | 2 7/8 | |
| | EVPBLTCPA348P | 304 | 48 | 2 7/8 | |
| | EVPBLTCPA354P | 335 | 54 | 2 7/8 | |
| | EVPBLTCPA366P | 395 | 66 | 2 7/8 | |

EVVPA3 - THREE-WAY VARIABLE - HEIGHT POST - ALUMINUM TRIM

- Connects three panels of differing height in a "T" configuration.
- Connector must reference taller panel.
- Post and connecting hardware adds 3.25" to the panel run.
- Provides slotted support for worksurfaces and hang-on storage components.
- Includes one post, three slotted connectors with leveling glides, connecting hardware and trim kit.
- Connectors available without slots, as a special at no upcharge. Contact Customer Support.
- Please see page 92 on how to specify.

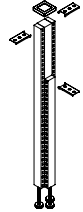
| DESCRIPTION | PRODUCT CODE | LIST PRICE | DIMENSIONS/INCHES | | |
|--|--------------|------------|-------------------|-------|---|
| | | | H | W | D |
|  Three-Way Variable - Height Post - Aluminum Trim | EVVPA342 | 277 | 42 | 2 7/8 | |
| | EVVPA348 | 304 | 48 | 2 7/8 | |
| | EVVPA354 | 335 | 54 | 2 7/8 | |
| | EVVPA366 | 395 | 66 | 2 7/8 | |

EVPLTVPA3 - THREE WAY VARIABLE HEIGHT CORNER POST FOR LIGHT PANEL

- Connects three Light panel of differing height in "T" configuration.
- Connector must reference taller panel.
- Post and connecting hardware add 3.25" to power beam run.
- Provides slotted support for worksurfaces and hang on components.
- Includes post, panel connectors and power beam connectors, post with trim all around, levelling glide, hardware and trim kit.
- Leg trim matches selected trim color.
- Connectors available without slots, as a special at no extra charge. Contact customer support.

| DESCRIPTION | PRODUCT CODE | LIST PRICE | DIMENSIONS/INCHES | | |
|---|--------------|------------|-------------------|-------|---|
| | | | H | W | D |
|  Three Way Variable Height Corner Post for Light Panel | EVPLTVPA342 | 277 | 42 | 2 7/8 | |
| | EVPLTVPA348 | 304 | 48 | 2 7/8 | |
| | EVPLTVPA354 | 335 | 54 | 2 7/8 | |
| | EVPLTVPA366 | 395 | 66 | 2 7/8 | |

EVPLTVPA3P- THREE WAY VARIABLE HEIGHT CORNER POST FOR LIGHT PANEL - PANEL

- Connects one Light panel and two Panels of differing height in "T" configuration, Panel-Light Panel-Panel.
- Connector must reference taller panel.
- Post and connecting hardware add 3.25" to power beam run.
- Provides slotted support for worksurfaces and hang on components.
- Includes post, panel connectors and power beam connectors, post with trim all around, levelling glide, hardware and trim kit.
- Leg trim matches selected trim color.
- Connectors are available without slots, as a special at no extra charge. Contact customer support.

| DESCRIPTION | PRODUCT CODE | LIST PRICE | DIMENSIONS/INCHES | | |
|-------------|--------------|------------|-------------------|---|---|
| | | | H | W | D |

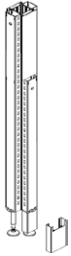

Three Way Variable Height Corner Post for Panel-Light Panel-Panel

| | | | |
|--------------|-----|----|-------|
| EVPLTVPA342P | 277 | 42 | 2 7/8 |
| EVPLTVPA348P | 304 | 48 | 2 7/8 |
| EVPLTVPA354P | 335 | 54 | 2 7/8 |
| EVPLTVPA366P | 395 | 66 | 2 7/8 |

EVPBVPA3 - THREE-WAY VARIABLE - HEIGHT POST FOR BELTLINE POWERED PANELS - ALUMINUM TRIM

- Connects three Beltline Powered panels of differing height in a "T" configuration.
- Connector must reference taller panel.
- Post and connecting hardware adds 3.25" to the panel run.
- Provides slotted support for worksurfaces and hang-on storage components.
- Includes one post, three slotted connectors with leveling glides, connecting hardware and trim kit.
- Connectors available without slots, as a special at no upcharge. Contact Customer Support.
- Please see page 92 on how to specify.

| DESCRIPTION | PRODUCT CODE | LIST PRICE | DIMENSIONS/INCHES | | |
|-------------|--------------|------------|-------------------|---|---|
| | | | H | W | D |

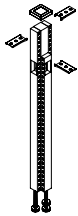

Three-Way Variable - Height Post for Beltline Powered Panels - Aluminum Trim

| | | | |
|------------|-----|----|-------|
| EVPBVPA354 | 335 | 54 | 2 7/8 |
| EVPBVPA366 | 395 | 66 | 2 7/8 |



EVPBLTVPA3 - THREE WAY VARIABLE HEIGHT CORNER POST FOR BELTLINE LIGHT PANEL

- Connects one Beltline Light panel and two beltline Panels of differing height in "T" configuration.
- Connector must reference taller panel.
- Post and connecting hardware add 3.25" to power beam run.
- Provides slotted support for worksurfaces and hang on components.
- Includes post, panel connectors and power beam connectors, post with trim all around, levelling glide, hardware and trim kit.
- Leg trim matches selected trim color.
- Connectors available without slots, as a special at no extra charge. Contact customer support.

| | DESCRIPTION | PRODUCT CODE | LIST PRICE | DIMENSIONS/INCHES | | |
|---|--|--------------|------------|-------------------|-------|---|
| | | | | H | W | D |
|  | Three Way Variable Height Corner Post for Beltline Light Panel | EVPBLTVPA354 | 335 | 54 | 2 7/8 | |
| | | EVPBLTVPA366 | 395 | 66 | 2 7/8 | |

EVPBLTVPA3P - THREE WAY VARIABLE HEIGHT CORNER POST FOR BELTLINE LIGHT PANEL

- Connects one Beltline Light panel and two Beltline panels of equal height in "T" configuration.
- Connector must reference taller panel.
- Post and connecting hardware add 3.25" to power beam run.
- Provides slotted support for worksurfaces and hang on components.
- Includes post, panel connectors and power beam connectors, post with trim all around, levelling glide, hardware and trim kit.
- Leg trim matches selected trim color.
- Connectors are available without slots, as a special at no extra charge. Contact customer support.

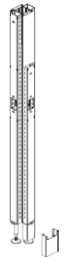
| | DESCRIPTION | PRODUCT CODE | LIST PRICE | DIMENSIONS/INCHES | | |
|---|--|---------------|------------|-------------------|-------|---|
| | | | | H | W | D |
|  | Three Way Variable Height Corner Post for Beltline | EVPBLTVPA354P | 335 | 54 | 2 7/8 | |
| | Light Panel | EVPBLTVPA366P | 395 | 66 | 2 7/8 | |

EVPCP4 - FOUR-WAY POST

- Connects four panels of equal height in a “+” configuration.
- Post and connecting hardware adds 3.25” to the panel run.
- Provides slotted support for worksurfaces and hang-on storage components.
- Includes one post, four slotted connectors with leveling glides and connecting hardware.
- Connectors available without slots, as a special at no upcharge. Contact Customer Support.

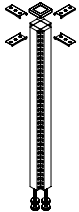
| DESCRIPTION | PRODUCT CODE | LIST PRICE | DIMENSIONS/INCHES | | |
|--|--------------|------------|-------------------|-------|---|
| | | | H | W | D |
|  <p>Four-Way Post</p> | EVPCP430 | 257 | 30 | 2 7/8 | |
| | EVPCP442 | 325 | 42 | 2 7/8 | |
| | EVPCP448 | 360 | 48 | 2 7/8 | |
| | EVPCP454 | 393 | 54 | 2 7/8 | |
| | EVPCP466 | 459 | 66 | 2 7/8 | |

EVPLTCPA4 - FOUR WAY CORNER POST FOR LIGHT PANEL

- Connects three Light panel of equal height in “+” configuration.
- Post and connecting hardware add 3.25” to power beam run.
- Provides slotted support for worksurfaces and hang on components.
- Includes post, panel connectors and power beam connectors, post with trim all around, levelling glide, hardware and trim kit.
- Leg trim matches selected trim color.
- Connectors available without slots, as a special at no extra charge. Contact customer support.

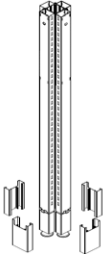
| DESCRIPTION | PRODUCT CODE | LIST PRICE | DIMENSIONS/INCHES | | |
|--|--------------|------------|-------------------|-------|---|
| | | | H | W | D |
|  <p>Four Way Corner Post for Light Panel</p> | EVPLTCPA430 | 257 | 30 | 2 7/8 | |
| | EVPLTCPA442 | 325 | 42 | 2 7/8 | |
| | EVPLTCPA448 | 360 | 48 | 2 7/8 | |
| | EVPLTCPA454 | 393 | 54 | 2 7/8 | |
| | EVPLTCPA466 | 459 | 66 | 2 7/8 | |

EVPLTCPA4P- FOUR WAY CORNER POST FOR LIGHT PANEL - PANEL

- Connects two Beltline Light panel and two Beltline Panels of equal height in “+” configuration.
- Post and connecting hardware add 3.25” to power beam run.
- Provides slotted support for worksurfaces and hang on components.
- Includes post, panel connectors and power beam connectors, post with trim all around, levelling glide, hardware and trim kit.
- Leg trim matches selected trim color.
- Connectors are available without slots, as a special at no extra charge. Contact customer support.

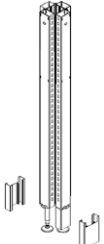
| DESCRIPTION | PRODUCT CODE | LIST PRICE | DIMENSIONS/INCHES | | |
|---|--------------|------------|-------------------|-------|---|
| | | | H | W | D |
|  <p>Four Way Corner Post for Light Panel-Panel</p> | EVPLTCPA430P | 257 | 30 | 2 7/8 | |
| | EVPLTCPA442P | 325 | 42 | 2 7/8 | |
| | EVPLTCPA448P | 360 | 48 | 2 7/8 | |
| | EVPLTCPA454P | 393 | 54 | 2 7/8 | |
| | EVPLTCPA466P | 459 | 66 | 2 7/8 | |



EVPBCP4 - FOUR-WAY POST FOR BELTLINE POWERED PANELS

- Connects four Beltline Powered panels of equal height in a “+” configuration.
- Post and connecting hardware adds 3.25” to the panel run.
- Provides slotted support for worksurfaces and hang-on storage components.
- Includes one post, four slotted connectors with leveling glides and connecting hardware.
- Connectors available without slots, as a special at no upcharge. Contact Customer Support.

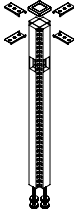
| DESCRIPTION | PRODUCT CODE | LIST PRICE | DIMENSIONS/INCHES | | |
|--|--------------|------------|-------------------|-------|---|
| | | | H | W | D |
|  <p>Four-Way Post for Beltline Powered Panels</p> | EVPBCP442 | 325 | 42 | 2 7/8 | |
| | EVPBCP454 | 393 | 54 | 2 7/8 | |
| | EVPBCP466 | 459 | 66 | 2 7/8 | |

EVBLTCA4 - FOUR WAY CORNER POST FOR BELTLINE LIGHT PANEL

- Connects four Light panel of equal height in “+” configuration.
- Post and connecting hardware add 3.25” to power beam run.
- Provides slotted support for worksurfaces and hang on components.
- Includes post, panel connectors and power beam connectors, post with trim all around, levelling glide, hardware and trim kit.
- Leg trim matches selected trim color.
- Connectors available without slots, as a special at no extra charge. Contact customer support.

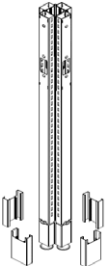
| DESCRIPTION | PRODUCT CODE | LIST PRICE | DIMENSIONS/INCHES | | |
|---|--------------|------------|-------------------|---|---|
| | | | H | W | D |
|  <p>Four Way Corner Post for Beltline Light Panel</p> | EVBLTCA442 | 325 | 42 | 2 | |
| | EVBLTCA448 | 360 | 48 | 2 | |
| | EVBLTCA454 | 393 | 54 | 2 | |
| | EVBLTCA466 | 459 | 66 | 2 | |

EVPLTVA4P- FOUR WAY VARIABLE HEIGHT CORNER POST FOR LIGHT PANEL - PANEL

- Connects two Light panels and two Panels of differing height in “+” configuration, Panel-Light Panel-Panel-Light Panel.
- Connector must reference taller panel.
- Post and connecting hardware add 3.25” to power beam run.
- Provides slotted support for worksurfaces and hang on components.
- Includes post, panel connectors and power beam connectors, post with trim all around, levelling glide, hardware and trim kit.
- Leg trim matches selected trim color.
- Connectors are available without slots, as a special at no extra charge. Contact customer support.

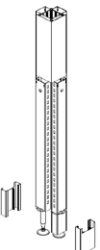
| DESCRIPTION | PRODUCT CODE | LIST PRICE | DIMENSIONS/INCHES | | |
|--|--------------|------------|-------------------|-------|---|
| | | | H | W | D |
|  <p>Three Way Variable Height Corner Post for Panel-Light Panel-Panel-Light Panel</p> | EVPLTVA442P | 325 | 42 | 2 7/8 | |
| | EVPLTVA448P | 360 | 48 | 2 7/8 | |
| | EVPLTVA454P | 393 | 54 | 2 7/8 | |
| | EVPLTVA466P | 459 | 66 | 2 7/8 | |

EVPVPA4 - FOUR-WAY VARIABLE - HEIGHT POST - ALUMINUM TRIM

- Connects four panels of differing heights in a "+" configuration.
- Connector must reference taller panel.
- Post and connecting hardware adds 3.25" to the panel run.
- Provides slotted support for worksurfaces and hang-on storage components.
- Includes one post, four slotted connectors with leveling glides, connecting hardware and trim kit.
- Connectors available without slots, as a special at no upcharge. Contact Customer Support.
- Please see page 92 on how to specify.

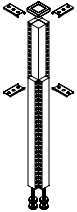
| | DESCRIPTION | PRODUCT CODE | LIST PRICE | DIMENSIONS/INCHES | | |
|---|--|--------------|------------|-------------------|-------|---|
| | | | | H | W | D |
|  | Four-Way Variable - Height Corner Post - Aluminum Trim | EVPVPA442 | 325 | 42 | 2 7/8 | |
| | | EVPVPA448 | 360 | 48 | 2 7/8 | |
| | | EVPVPA454 | 393 | 54 | 2 7/8 | |
| | | EVPVPA466 | 459 | 66 | 2 7/8 | |

EVPLTVPA4 - FOUR WAY VARIABLE HEIGHT CORNER POST FOR LIGHT PANEL

- Connects four Light panel of differing height in "+" configuration.
- Connector must reference taller panel.
- Post and connecting hardware add 3.25" to power beam run.
- Provides slotted support for worksurfaces and hang on components.
- Includes post, panel connectors and power beam connectors, post with trim all around, levelling glide, hardware and trim kit.
- Leg trim matches selected trim color.
- Connectors available without slots, as a special at no extra charge. Contact customer support.

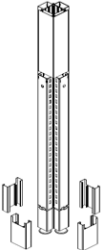
| | DESCRIPTION | PRODUCT CODE | LIST PRICE | DIMENSIONS/INCHES | | |
|--|--|--------------|------------|-------------------|-------|---|
| | | | | H | W | D |
|  | Four Way Variable Height Corner Post for Light Panel | EVPLTVPA442 | 325 | 42 | 2 7/8 | |
| | | EVPLTVPA448 | 360 | 48 | 2 7/8 | |
| | | EVPLTVPA454 | 393 | 54 | 2 7/8 | |
| | | EVPLTVPA466 | 459 | 66 | 2 7/8 | |

EVPLTCA4P - FOUR WAY CORNER POST FOR BELTLINE LIGHT PANEL

- Connects two Beltline Light panel and two Beltline Panels of equal height in "+" configuration.
- Post and connecting hardware add 3.25" to power beam run.
- Provides slotted support for worksurfaces and hang on components.
- Leg trim matches selected trim color.
- Includes post, panel connectors and power beam connectors, post with trim all around, levelling glide, hardware and trim kit.
- Connectors are available without slots, as a special at no extra charge. Contact customer support.

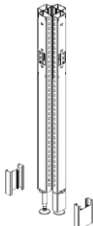
| | DESCRIPTION | PRODUCT CODE | LIST PRICE | DIMENSIONS/INCHES | | |
|---|---|--------------|------------|-------------------|-------|---|
| | | | | H | W | D |
|  | Four Way Corner Post Beltline Light Panel | EVPLTCA442P | 257 | 42 | 2 7/8 | |
| | | EVPLTCA448P | 325 | 48 | 2 7/8 | |
| | | EVPLTCA454P | 360 | 54 | 2 7/8 | |
| | | EVPLTCA466P | 459 | 66 | 2 7/8 | |



EVPBVPA4 - FOUR-WAY VARIABLE - HEIGHT POST FOR BELTLINE POWERED PANELS - ALUMINUM TRIM

- Connects four Beltline Powered panels of differing heights in an a "+" configuration.
- Connector must reference taller panel.
- Post and connecting hardware adds 3.25" to the panel run.
- Provides slotted support for worksurfaces and hang-on storage components.
- Includes one post, four slotted connectors with leveling glides, connecting hardware and trim kit.
- Connectors available without slots, as a special at no upcharge. Contact Customer Support.
- Please see page 92 on how to specify.

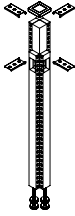
| | DESCRIPTION | PRODUCT CODE | LIST PRICE | DIMENSIONS/INCHES | | |
|---|---|--------------|------------|-------------------|-------|---|
| | | | | H | W | D |
|  | Four-Way Variable - Height Post for Beltline Powered Panels - Aluminum Trim | EVPBVPA454 | 393 | 54 | 2 7/8 | |
| | | EVPBVPA466 | 459 | 66 | 2 7/8 | |

EVPBLTVA4 - FOUR WAY VARIABLE HEIGHT CORNER POST FOR BELTLINE LIGHT PANEL

- Connects four Light panel of differing height in "+" configuration.
- Connector must reference taller panel.
- Post and connecting hardware add 3.25" to power beam run.
- Provides slotted support for worksurfaces and hang on components.
- Includes post, panel connectors and power beam connectors, post with trim all around, levelling glide, hardware and trim kit.
- Leg trim matches selected trim color.
- Connectors available without slots, as a special at no extra charge. Contact customer support.

| | DESCRIPTION | PRODUCT CODE | LIST PRICE | DIMENSIONS/INCHES | | |
|--|---|--------------|------------|-------------------|-------|---|
| | | | | H | W | D |
|  | Four Way Variable Height Corner Post for Beltline Light Panel Aluminum Trim | EVPBLTVA454 | 393 | 54 | 2 7/8 | |
| | | EVPBLTVA466 | 459 | 66 | 2 7/8 | |

EVPBLTVA4P- FOUR WAY VARIABLE HEIGHT CORNER POST FOR BELTLINE LIGHT PANEL

- Connects two Beltline Light panel and two Beltline Panels of differing height in "+" configuration.
- Connector must reference taller panel.
- Post and connecting hardware add 3.25" to power beam run.
- Provides slotted support for worksurfaces and hang on components.
- Includes post, panel connectors and power beam connectors, post with trim all around, levelling glide, hardware and trim kit.
- Leg trim matches selected trim color.
- Connectors are available without slots, as a special at no extra charge. Contact customer support.

| | DESCRIPTION | PRODUCT CODE | LIST PRICE | DIMENSIONS/INCHES | | |
|---|---|--------------|------------|-------------------|-------|---|
| | | | | H | W | D |
|  | Four Way Variable Height Corner Post for Beltline Light Panel | EVPBLTVA454P | 393 | 54 | 2 7/8 | |
| | | EVPBLTVA466P | 459 | 66 | 2 7/8 | |

EVPCPA1 - ONE-WAY POST - ALUMINUM TRIM

- Connects at the end of a panel run in place of an EVPERA – End-of-Run Post Kit.
- Should not be used to attach a panel to a fixed wall.
- Post and connecting hardware adds 3.25" to the panel run.
- Provides slotted support for worksurfaces and hang-on storage components.
- Includes one post and one slotted connector with a leveling glide, connecting hardware and trim kit.
- Connectors available without slots, as a special at no upcharge. Contact Customer Support.

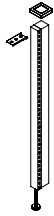
| DESCRIPTION | PRODUCT CODE | LIST PRICE | DIMENSIONS/INCHES | | |
|---|--------------|------------|-------------------|-------|---|
| | | | H | W | D |
|  <p>One-Way Post - Aluminum Trim</p> | EVPCPA130 | 119 | 30 | 2 7/8 | |
| | EVPCPA142 | 136 | 42 | 2 7/8 | |
| | EVPCPA148 | 159 | 48 | 2 7/8 | |
| | EVPCPA154 | 182 | 54 | 2 7/8 | |
| | EVPCPA166 | 223 | 66 | 2 7/8 | |

EVPLTCPA1 - ONE WAY CORNER POST FOR LIGHT PANEL

- Connects at end of Light panel run in place of EVPERA- End of run post kit..
- Should not be used to attach panel to fixed wall.
- Post and connecting hardware add 3.25" to power beam run.
- Provides slotted support to worksurfaces and hang on components.
- Includes post, panel connectors and power beam connectors, post with trim all around, levelling glide, hardware and trim kit.
- Connectors are available without slots, as a special at no extra charge. Contact customer support

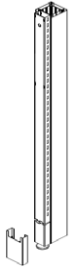
| DESCRIPTION | PRODUCT CODE | LIST PRICE | DIMENSIONS/INCHES | | |
|---|--------------|------------|-------------------|-------|---|
| | | | H | W | D |
|  <p>One Way Corner Post for Light Panel</p> | EVPLTCPA130 | 119 | 30 | 2 7/8 | |
| | EVPLTCPA142 | 136 | 30 | 2 7/8 | |
| | EVPLTCPA148 | 159 | 30 | 2 7/8 | |
| | EVPLTCPA154 | 182 | 30 | 2 7/8 | |
| | EVPLTCPA166 | 223 | 30 | 2 7/8 | |



EVPBCPA1 - ONE-WAY POST FOR BELTLINE POWERED PANELS - ALUMINUM TRIM

- Connects at the end of a Beltline Powered panel run in place of an EVPERA – End-of-Run Post Kit.
- Should not be used to attach a panel to a fixed wall.
- Post and connecting hardware adds 3.25" to the panel run.
- Provides slotted support for worksurfaces and hang-on storage components.
- Includes one post and one slotted connector with a leveling glide, connecting hardware and trim kit.
- Connectors available without slots, as a special at no upcharge. Contact Customer Support.

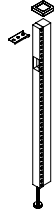

| DESCRIPTION | PRODUCT CODE | LIST PRICE | DIMENSIONS/INCHES | | |
|--|--------------|------------|-------------------|-------|---|
| | | | H | W | D |
| One-Way Post for Beltline Powered Panels - Aluminum Trim | EVPBCPA142 | 136 | 42 | 2 7/8 | |
| | EVPBCPA154 | 182 | 54 | 2 7/8 | |
| | EVPBCPA166 | 223 | 66 | 2 7/8 | |

EVPBLTCPA1 - ONE WAY CORNER POST FOR BELTLINE LIGHT PANEL

- Connects at end of Light panel run in place of EVPERA- End of run post kit.
- Should not be used to attach pane to fixed wall.
- Post and connecting hardware add 3.25" to power beam run.
- Provides slotted support for worksurfaces and hang on components.
- Includes post, panel connectors and power beam connectors, post with trim all around, levelling glide, hardware and trim kit.
- Connectors are available without slots, as a special at no extra charge. Contact customer support.



| DESCRIPTION | PRODUCT CODE | LIST PRICE | DIMENSIONS/INCHES | | |
|--|--------------|------------|-------------------|---|---|
| | | | H | W | D |
| One Way Corner Post for Beltline Light Panel | EVPBLTCPA142 | 136 | 42 | 2 | |
| | EVPBLTCPA148 | 159 | 48 | 2 | |
| | EVPBLTCPA154 | 182 | 54 | 2 | |
| | EVPBLTCPA166 | 223 | 66 | 2 | |

EVPIPA2 - INLINE TWO-WAY POST - ALUMINUM TRIM

- Connects two panels of equal height in a straight line in place of EVPIC – In-Line Connector.
- Post and connecting hardware adds 3.25" to the panel run.
- Provides slotted support for worksurfaces and hang-on storage components.
- Includes one post, two slotted connectors with leveling glides, connecting hardware and trim kit.
- Connectors available without slots, as a special at no upcharge. Contact Customer Support.

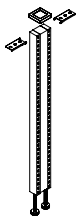
| | DESCRIPTION | PRODUCT CODE | LIST PRICE | DIMENSIONS/INCHES | | |
|---|-------------------------------------|--------------|------------|-------------------|-------|---|
| | | | | H | W | D |
|  | Inline Two-Way Post - Aluminum Trim | EVPIPA230 | 163 | 30 | 2 7/8 | |
| | | EVPIPA242 | 205 | 42 | 2 7/8 | |
| | | EVPIPA248 | 226 | 48 | 2 7/8 | |
| | | EVPIPA254 | 246 | 54 | 2 7/8 | |
| | | EVPIPA266 | 292 | 66 | 2 7/8 | |

EVLTPIPA2 - INLINE TWO WAY CORNER POST LIGHT PANEL

- Connects two Light panel of equal height in straight run.
- Post and connecting hardware add 3.25" to power beam run.
- Provides slotted support for worksurfaces and hang on components.
- Includes post, panel connectors and power beam connectors, post with trim all around, levelling glide, hardware and trim kit.
- Leg trim matches selected trim color.
- Connectors are available without slots, as a special at no extra charge. Contact customer support.

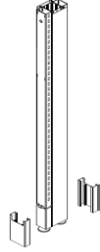
| | DESCRIPTION | PRODUCT CODE | LIST PRICE | DIMENSIONS/INCHES | | |
|--|--|--------------|------------|-------------------|-------|---|
| | | | | H | W | D |
|  | Inline Two way Corner Post Light Panel | EVPLTPIPA230 | 163 | 30 | 2 7/8 | |
| | | EVPLTPIPA242 | 205 | 42 | 2 7/8 | |
| | | EVPLTPIPA248 | 226 | 48 | 2 7/8 | |
| | | EVPLTPIPA254 | 246 | 54 | 2 7/8 | |
| | | EVPLTPIPA266 | 292 | 66 | 2 7/8 | |



EVPBIPA2 - INLINE TWO-WAY POST FOR BELTLINE POWERED PANELS - ALUMINUM TRIM

- Connects two Beltline Powered panels of equal height in between a post in a straight line in place of EVPIC – In-Line Connector.
- Post and connecting hardware adds 3.25" to the panel run.
- Provides slotted support for worksurfaces and hang-on storage components.
- Includes one post, two slotted connectors with leveling glides, connecting hardware and trim kit.
- Connectors available without slots, as a special at no upcharge. Contact Customer Support.

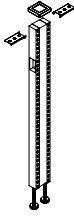
| | DESCRIPTION | PRODUCT CODE | LIST PRICE | DIMENSIONS/INCHES | | |
|---|---|--------------|------------|-------------------|-------|---|
| | | | | H | W | D |
|  | Inline Two-Way Post for Beltline Powered Panels - Aluminum Trim | EVPBIPA242 | 205 | 42 | 2 7/8 | |
| | | EVPBIPA254 | 246 | 54 | 2 7/8 | |
| | | EVPBIPA266 | 292 | 66 | 2 7/8 | |

EVPBLTPIPA2 - INLINE TWO WAY CORNER POST BELTLINE LIGHT PANEL

- Connects two Light panel of equal height in straight run.
- Post and connecting hardware add 3.25" to power beam run.
- Provides slotted support for worksurfaces and hang on components.
- Leg trim matches selected trim color.
- Includes post, panel connectors and power beam connectors, post with trim all around, levelling glide, hardware and trim kit.
- Connectors are available without slots, as a special at no extra charge. Contact customer support.

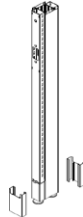
| | DESCRIPTION | PRODUCT CODE | LIST PRICE | DIMENSIONS/INCHES | | |
|--|---|---------------|------------|-------------------|-------|---|
| | | | | H | W | D |
|  | Inline Two Way Corner Post Beltline Light Panel | EVPBLTPIPA242 | 205 | 42 | 2 7/8 | |
| | | EVPBLTPIPA248 | 226 | 48 | 2 7/8 | |
| | | EVPBLTPIPA254 | 246 | 54 | 2 7/8 | |
| | | EVPBLTPIPA266 | 292 | 66 | 2 7/8 | |

EVP6PA2 - TWO-WAY 60 DEGREE POST - ALUMINUM TRIM

- Connects two panels of equal height in a 120 degree configuration.
- Provides slotted support for worksurfaces and hang-on storage components.
- Includes one 60 degree post, two slotted connectors with leveling glides, connecting hardware and trim kit.
- Connectors available without slots as a special at no upcharge. Contact Customer Service.

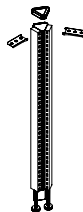
| | DESCRIPTION | PRODUCT CODE | LIST PRICE | DIMENSIONS/INCHES | | |
|---|-----------------------------------|--------------|------------|-------------------|------|---|
| | | | | H | W | D |
|  | Two-Way 60 Degree Post - Aluminum | EVP6PA230 | 168 | 30 | 3.65 | |
| | | EVP6PA242 | 207 | 42 | 3.65 | |
| | | EVP6PA248 | 223 | 48 | 3.65 | |
| | | EVP6PA254 | 259 | 54 | 3.65 | |
| | | EVP6PA266 | 304 | 66 | 3.65 | |

EVPB6PA2 - TWO-WAY 60 DEGREE POST FOR BELTLINE POWERED PANELS - ALUMINUM TRIM

- Connects two Beltline Powered panels of equal height in a 120 degree configuration.
- Provides slotted support for worksurfaces and hang-on storage components.
- Includes one 60 degree post, two slotted connectors with leveling glides, connecting hardware and trim kit.
- Connectors available without slots, as a special at no upcharge. Contact Customer Support.

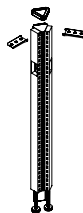
| | DESCRIPTION | PRODUCT CODE | LIST PRICE | DIMENSIONS/INCHES | | |
|--|--|--------------|------------|-------------------|------|---|
| | | | | H | W | D |
|  | Two-Way 60 Degree Post for Beltline Powered Panels - Aluminum Trim | EVPB6PA242 | 239 | 42 | 3.65 | |
| | | EVPB6PA254 | 259 | 54 | 3.65 | |
| | | EVPB6PA266 | 304 | 66 | 3.65 | |

EVP6VPA2 - TWO-WAY 60 DEGREE VARIABLE - HEIGHT POST - ALUMINUM TRIM

- Connects two panels of differing height in a 120 degree configuration.
- Connector must reference taller panel.
- Provides slotted support for worksurfaces and hang-on storage components.
- Includes one 60 degree post, two slotted connectors with leveling glides, connecting hardware and trim kit.
- Connectors available without slots, as a special at no upcharge. Contact Customer Support.
- Please see page 92 on how to specify.

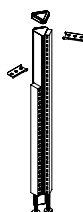
| | DESCRIPTION | PRODUCT CODE | LIST PRICE | DIMENSIONS/INCHES | | |
|---|--|--------------|------------|-------------------|------|---|
| | | | | H | W | D |
|  | Two-Way 60 Degree Variable - Height Post - Aluminum Trim | EVP6VPA242 | 207 | 42 | 3.65 | |
| | | EVP6VPA248 | 233 | 48 | 3.65 | |
| | | EVP6VPA254 | 259 | 54 | 3.65 | |
| | | EVP6VPA266 | 306 | 66 | 3.65 | |



EVPB6VPA2 - TWO-WAY 60 DEGREE VARIABLE - HEIGHT POST FOR BELTLINE POWERED PANELS - ALUMINUM TRIM

- Connects two Beltline Powered panels of differing height in a 120 degree configuration.
- Connector must reference taller panel.
- Provides slotted support for worksurfaces and hang-on storage components.
- Includes one 60 degree post, two slotted connectors with leveling glides, connecting hardware and trim kit.
- Connectors available without slots, as a special at no upcharge. Contact Customer Support.
- Please see page 92 on how to specify.

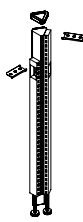
| DESCRIPTION | PRODUCT CODE | LIST PRICE | DIMENSIONS/INCHES | | |
|--|--------------|------------|-------------------|------|---|
| | | | H | W | D |
|  Two-Way 60 Degree Variable - Height Post for Beltline Powered Panels - Aluminum Trim | EVPB6VPA242 | 207 | 42 | 3.65 | |
| | EVPB6VPA254 | 259 | 54 | 3.65 | |
| | EVPB6VPA266 | 306 | 66 | 3.65 | |

EVP6P3 - THREE-WAY 60 DEGREE POST

- Connects three panels of equal height in a 120 degree configuration.
- Provides slotted support for worksurfaces and hang-on storage components.
- Includes one 60 degree post, three slotted connectors with leveling glides and connecting hardware.
- Connectors available without slots, as a special at no upcharge. Contact Customer Support.

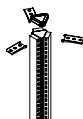
| DESCRIPTION | PRODUCT CODE | LIST PRICE | DIMENSIONS/INCHES | | |
|---|--------------|------------|-------------------|------|---|
| | | | H | W | D |
|  Three-Way 60 Degree Post | EVP6P330 | 206 | 30 | 3.65 | |
| | EVP6P342 | 274 | 42 | 3.65 | |
| | EVP6P348 | 304 | 48 | 3.65 | |
| | EVP6P354 | 335 | 54 | 3.65 | |
| | EVP6P366 | 395 | 66 | 3.65 | |

EVPB6P3 - THREE-WAY 60 DEGREE POST FOR BELTLINE POWERED PANELS

- Connects three Beltline Powered panels of equal height in a 120 degree configuration.
- Provides slotted support for worksurfaces and hang-on storage components.
- Includes one 60 degree post, three slotted connectors with leveling glides and connecting hardware.
- Connectors available without slots, as a special at no upcharge. Contact Customer Support.

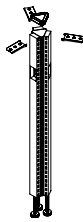
| DESCRIPTION | PRODUCT CODE | LIST PRICE | DIMENSIONS/INCHES | | |
|--|--------------|------------|-------------------|------|---|
| | | | H | W | D |
|  Three-Way 60 Degree Post for Beltline Powered Panels | EVPB6P342 | 262 | 42 | 3.65 | |
| | EVPB6P354 | 319 | 54 | 3.65 | |
| | EVPB6P366 | 376 | 66 | 3.65 | |

EVP6VPA3 - THREE-WAY 60 DEGREE VARIABLE - HEIGHT POST - ALUMINUM TRIM

- Connects three panels of differing height in a 120 degree configuration.
- Connector must reference taller panel.
- Provides slotted support for worksurfaces and hang-on storage components.
- Includes one 60 degree post, three slotted connectors with leveling glides, connecting hardware and trim kit.
- Connectors available without slots, as a special at no upcharge. Contact Customer Support.
- Please see page 92 on how to specify.

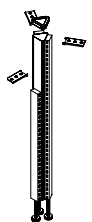
| DESCRIPTION | PRODUCT CODE | LIST PRICE | DIMENSIONS/INCHES | | |
|--|--------------|------------|-------------------|------|---|
| | | | H | W | D |
|  Three-Way 60 Degree Variable - Height Post - Aluminum Trim | EVP6VPA342 | 274 | 42 | 3.65 | |
| | EVP6VPA348 | 304 | 48 | 3.65 | |
| | EVP6VPA354 | 335 | 54 | 3.65 | |
| | EVP6VPA366 | 395 | 66 | 3.65 | |

EVPB6VPA3 - THREE-WAY 60 DEGREE VARIABLE - HEIGHT POST FOR BELTLINE POWERED PANELS - ALUMINUM TRIM

- Connects three Beltline Powered panels of differing height in a 120 degree configuration.
- Connector must reference taller panel.
- Provides slotted support for worksurfaces and hang-on storage components.
- Includes one 60 degree post, three slotted connectors with leveling glides, connecting hardware and trim kit.
- Connectors available without slots, as a special at no upcharge. Contact Customer Support.
- Please see page 92 on how to specify.

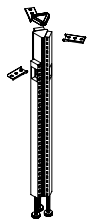
| DESCRIPTION | PRODUCT CODE | LIST PRICE | DIMENSIONS/INCHES | | |
|---|--------------|------------|-------------------|------|---|
| | | | H | W | D |
|  Three-Way for 60 Degree Variable - Height Post for Beltline Powered Panels - Aluminum Trim | EVPB6VPA342 | 301 | 42 | 3.65 | |
| | EVPB6VPA354 | 335 | 54 | 3.65 | |
| | EVPB6VPA366 | 395 | 66 | 3.65 | |

EVP4P2 - TWO-WAY 45 DEGREE POST - ALUMINUM TRIM

- Connects two panels of equal height in a 135 degree configuration.
- Provides slotted support for worksurfaces and hang-on storage components.
- Includes one 45 degree post, two slotted connectors with leveling glides, connecting hardware and trim kit.
- Connectors available without slots, as a special at no upcharge. Contact Customer Support.

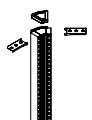
| DESCRIPTION | PRODUCT CODE | LIST PRICE | DIMENSIONS/INCHES | | |
|--|--------------|------------|-------------------|------|---|
| | | | H | W | D |
|  Two-Way 45 Degree Post Aluminum Trim | EVP4P230 | 168 | 30 | 3.65 | |
| | EVP4P242 | 207 | 42 | 3.65 | |
| | EVP4P248 | 223 | 48 | 3.65 | |
| | EVP4P254 | 259 | 54 | 3.65 | |
| | EVP4P266 | 304 | 66 | 3.65 | |



EVP4VPA2 - TWO-WAY 45 DEGREE VARIABLE - HEIGHT POST - ALUMINUM TRIM

- Connects two panels of differing height in a 135 degree configuration.
- Connector must reference taller panel.
- Provides slotted support for worksurfaces and hang-on storage components.
- Includes one 45 degree post, two slotted connectors with leveling glides, connecting hardware and trim kit.
- Connectors available without slots, as a special at no upcharge. Contact Customer Support.
- Please see page 92 on how to specify.

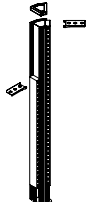
| | DESCRIPTION | PRODUCT CODE | LIST PRICE | DIMENSIONS/INCHES | | |
|---|--|--------------|------------|-------------------|------|---|
| | | | | H | W | D |
|  | Two-Way 45 Degree Variable - Height Post | EVP4VPA242 | 274 | 42 | 3.65 | |
| | Aluminum Trim | EVP4VPA248 | 304 | 48 | 3.65 | |
| | | EVP4VPA254 | 335 | 54 | 3.65 | |
| | | EVP4VPA266 | 395 | 66 | 3.65 | |

EVPUERA - UPMOUNT END-OF-RUN POST KIT - ALUMINUM TRIM

- Used at the end of Panel run to support Worksurfaces and Upmount Overhead Storage.
- Can attach to a Panel run to fixed wall.
- Adds 1" to the width of Light Panel run.
- 10% upcharge for Tungsten trim/paint.
- Aluminum trim must be specified when using premium color paints. Premium color paints are not available on PVC trim.

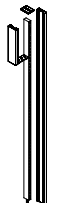
| | DESCRIPTION | PRODUCT CODE | LIST PRICE | DIMENSIONS/INCHES | | |
|--|--|--------------|------------|-------------------|-------|---|
| | | | | H | W | D |
|  | Upmount End-of-Run Post Kit - Aluminum Trim. | EVPUERA66 | 152 | 66 | 2 7/8 | |

EVPLUERA - UPMOUNT END-OF-RUN POST KIT FOR LIGHT PANELS (WALL MOUNTABLE) - ALUMINUM

- Used at the end of Panel run to support Worksurfaces and Upmount Overhead Storage.
- Can attach to a Panel run to fixed wall.
- Adds 1" to the width of Light Panel run.
- Includes slotted Connector with leveling glide, connecting hardware, decorative sleeve and trim kit.

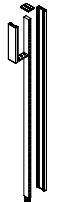
| | DESCRIPTION | PRODUCT CODE | LIST PRICE | DIMENSIONS/INCHES | | |
|---|--|--------------|------------|-------------------|-------|---|
| | | | | H | W | D |
|  | Upmount End-of Run Post Kit - for Light Panels - Wall Mountable - Aluminum | EVPLUERA66 | 152 | 66 | 2 7/8 | |

EVPUETA - UPMOUNT END-OF-RUN TRIM - ALUMINUM

- Replaces existing 66”h End-of-Run Trim Only
- Comes with one Upmount Extension Trim EVPUET12 and one Upmount End-of-Run Trim.
- Must be used in conjunction with slotted connectors.

| | DESCRIPTION | PRODUCT CODE | LIST PRICE | DIMENSIONS/INCHES | | |
|---|------------------------------------|--------------|------------|-------------------|-------|---|
| | | | | H | W | D |
|  | Upmount End-of-Run Trim - Aluminum | EVPUETA66 | 108 | | 2 7/8 | |

EVPLUETA - UPMOUNT END-OF-RUN TRIM FOR LIGHT PANELS - ALUMINUM

- Includes one Upmount Extension Trim EVPUETA12 and one Upmount End-of-Run Trim.
- Must be used in conjunction with Slotted Connector.

| | DESCRIPTION | PRODUCT CODE | LIST PRICE | DIMENSIONS/INCHES | | |
|--|---|--------------|------------|-------------------|-------|---|
| | | | | H | W | D |
|  | Upmount End-of-Run Trim for Light Panels - Aluminum | EVPLUETA66 | 108 | 63 | 2 7/8 | |

EVAFMB01 - FLOOR MOUNT PLATE

- Attaches to floor.
- Secures panel to floor.
- Attachement screws are not included.
- Care should be taken to use correct fasteners for type of floor.
- Available in chrome finish only.

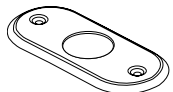
| | DESCRIPTION | PRODUCT CODE | LIST PRICE | DIMENSIONS/INCHES | | |
|---|-------------------|--------------|------------|-------------------|---|-----|
| | | | | H | W | D |
|  | Floor Mount Plate | EVAFMB01 | 91 | 0.25 | 5 | 2.5 |



EVPIECS - INLINE EXTENSION CONNECTOR - SLOTTED

- Connects two extension modules in a straight run.
- Includes one slotted inline extension connector and connecting hardware.
- Provides slotted support for worksurfaces and hang-on storage, up to 66”H.

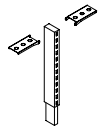

| DESCRIPTION | PRODUCT CODE | LIST PRICE | DIMENSIONS/INCHES | | |
|--------------------------------------|--------------|------------|-------------------|-------|---|
| | | | H | W | D |
| Inline Extension Connector - Slotted | EVPIECS06 | 49 | 6 | 2 7/8 | |
| | EVPIECS12 | 49 | 12 | 2 7/8 | |
| | EVPIECS18 | 58 | 18 | 2 7/8 | |
| | EVPIECS24 | 58 | 24 | 2 7/8 | |

EVPEERSA - END-OF-RUN EXTENSION CONNECTOR - SLOTTED - ALUMINUM TRIM

- Connects at the end of a run of extension modules, and can be used to attach a panel to a fixed wall.
- Adds 1” to the width of panel run.
- Includes one slotted inline extension connector, connecting hardware and trim kit.
- Provides slotted support for worksurfaces and hang-on storage, up to 66”H.

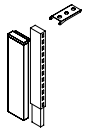

| DESCRIPTION | PRODUCT CODE | LIST PRICE | DIMENSIONS/INCHES | | |
|--|--------------|------------|-------------------|-------|---|
| | | | H | W | D |
| End-of-Run Extension Connector - Slotted - Aluminum Trim | EVPEERSA06 | 53 | 6 | 2 7/8 | |
| | EVPEERSA12 | 53 | 12 | 2 7/8 | |
| | EVPEERSA18 | 64 | 18 | 2 7/8 | |
| | EVPEERSA24 | 64 | 24 | 2 7/8 | |

EVPCEPSA2 - TWO-WAY POST EXTENSION - SLOTTED - ALUMINUM TRIM

- Connects two extension modules in a 90 degree configuration.
- Post and connecting hardware adds 3.25” to the panel run.
- Includes one post, two slotted inline extension connectors, connecting hardware and trim kit.
- Provides slotted support for worksurfaces and hang-on storage, up to 66”H.

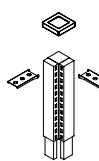

| DESCRIPTION | PRODUCT CODE | LIST PRICE | DIMENSIONS/INCHES | | |
|--|--------------|------------|-------------------|-------|---|
| | | | H | W | D |
| Two-Way Post Extension - Slotted Aluminum Trim | EVPCEPSA206 | 92 | 6 | 2 7/8 | |
| | EVPCEPSA212 | 92 | 12 | 2 7/8 | |
| | EVPCEPSA218 | 145 | 18 | 2 7/8 | |
| | EVPCEPSA224 | 145 | 24 | 2 7/8 | |

EVPCEPSA3 - THREE-WAY POST EXTENSION - SLOTTED - ALUMINUM TRIM

- Connects three extension modules in a “T” configuration.
- Post and connecting hardware adds 3.25” to the panel run.
- Includes one post, three slotted inline extension connectors, connecting hardware and trim kit.
- Provides slotted support for worksurfaces and hang-on storage, up to 66”H.

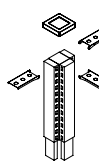

| DESCRIPTION | PRODUCT CODE | LIST PRICE | DIMENSIONS/INCHES | | |
|--|--------------|------------|-------------------|-------|---|
| | | | H | W | D |
| Three-Way Post Extension - Slotted Aluminum Trim | EVPCEPSA306 | 110 | 6 | 2 7/8 | |
| | EVPCEPSA312 | 110 | 12 | 2 7/8 | |
| | EVPCEPSA318 | 170 | 18 | 2 7/8 | |
| | EVPCEPSA324 | 170 | 24 | 2 7/8 | |

EVPCEPS4 - FOUR-WAY POST EXTENSION - SLOTTED

- Connects four extension modules in a “+” configuration.
- Post and connecting hardware adds 3.25” to the panel run.
- Includes one post, four slotted inline extension connectors, connecting hardware and trim kit.
- Provides slotted support for worksurfaces and hang-on storage, up to 66”H.

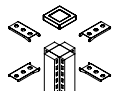
| DESCRIPTION | PRODUCT CODE | LIST PRICE | DIMENSIONS/INCHES | | |
|--|--------------|------------|-------------------|-------|---|
| | | | H | W | D |
|  Four-Way Post Extension - Slotted | EVPCEPS406 | 127 | 6 | 2 7/8 | |
| | EVPCEPS412 | 127 | 12 | 2 7/8 | |
| | EVPCEPS418 | 187 | 18 | 2 7/8 | |
| | EVPCEPS424 | 187 | 24 | 2 7/8 | |

EVPCEPSA1 - ONE-WAY POST EXTENSION - SLOTTED - ALUMINUM TRIM

- Connects at the end of a run of extension modules in place of an EVPEERSA – End-of-Run Extension Connector.
- Should not be used to attach a panel to a fixed wall.
- Post and connecting hardware adds 3.25” to the panel run.
- Includes one post, one slotted inline extension connector, connecting hardware and trim kit.
- Provides slotted support for worksurfaces and hang-on storage, up to 66”H.

| DESCRIPTION | PRODUCT CODE | LIST PRICE | DIMENSIONS/INCHES | | |
|---|--------------|------------|-------------------|-------|---|
| | | | H | W | D |
|  One-Way Post Extension - Slotted Aluminum Trim | EVPCEPSA106 | 90 | 6 | 2 7/8 | |
| | EVPCEPSA112 | 90 | 12 | 2 7/8 | |
| | EVPCEPSA118 | 114 | 18 | 2 7/8 | |
| | EVPCEPSA124 | 114 | 24 | 2 7/8 | |

EVPCEIPSA2 – INLINE TWO-WAY POST EXTENSION - SLOTTED - ALUMINUM TRIM

- Connects two extension modules in a straight line in place of EVPIECS – In-Line Extension Connector.
- Post and connecting hardware adds 3.25” to the panel run.
- Includes one post, two slotted inline extension connectors, connecting hardware and trim kit.
- Provides slotted support for worksurfaces and hang-on storage, up to 66”H.

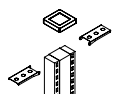
| DESCRIPTION | PRODUCT CODE | LIST PRICE | DIMENSIONS/INCHES | | |
|---|--------------|------------|-------------------|-------|---|
| | | | H | W | D |
|  Inline Two-Way Post Extension - Slotted Aluminum Trim | EVPCEIPSA206 | 97 | 6 | 2 7/8 | |
| | EVPCEIPSA212 | 97 | 12 | 2 7/8 | |
| | EVPCEIPSA218 | 158 | 18 | 2 7/8 | |
| | EVPCEIPSA224 | 158 | 24 | 2 7/8 | |



EVP6CEPSA2 - TWO-WAY 60 DEGREE POST EXTENSION - SLOTTED - ALUMINUM TRIM

- Connects two extension modules in a 120 degree configuration.
- Includes one post, two slotted inline extension connectors, connecting hardware and trim kit.
- Provides slotted support for worksurfaces and hang-on storage, up to 66"H.

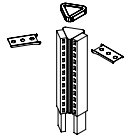

| DESCRIPTION | PRODUCT CODE | LIST PRICE | DIMENSIONS/INCHES | | |
|--|--------------|------------|-------------------|------|---|
| | | | H | W | D |
| Two-Way 60 Degree Post Extension - Slotted - Aluminum Trim | EVP6CEPSA206 | 92 | 6 | 3.65 | |
| | EVP6CEPSA212 | 92 | 12 | 3.65 | |
| | EVP6CEPSA218 | 142 | 18 | 3.65 | |
| | EVP6CEPSA224 | 142 | 24 | 3.65 | |

EVP6CEPS3 - THREE-WAY 60 DEGREE POST EXTENSION - SLOTTED

- Connects three extension modules in a 120 degree configuration.
- Includes one post, three slotted inline extension connectors and connecting hardware.
- Provides slotted support for worksurfaces and hang-on storage, up to 66"H.

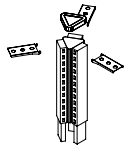

| DESCRIPTION | PRODUCT CODE | LIST PRICE | DIMENSIONS/INCHES | | |
|--|--------------|------------|-------------------|------|---|
| | | | H | W | D |
| Three-Way 60 Degree Post Extension - Slotted | EVP6CEPS306 | 109 | 6 | 3.65 | |
| | EVP6CEPS312 | 109 | 12 | 3.65 | |
| | EVP6CEPS318 | 170 | 18 | 3.65 | |
| | EVP6CEPS324 | 170 | 24 | 3.65 | |

EVP6CEPSA1 - ONE-WAY 60 DEGREE POST EXTENSION - SLOTTED - ALUMINUM TRIM

- Connects at the end of a run of extension modules in a 120 degree configuration.
- Should not be used to attach a panel to a fixed wall.
- Includes one post, one slotted inline extension connector, connecting hardware and trim kit.
- Provides slotted support for worksurfaces and hang-on storage, up to 66"H.

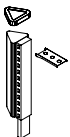

| DESCRIPTION | PRODUCT CODE | LIST PRICE | DIMENSIONS/INCHES | | |
|--|--------------|------------|-------------------|------|---|
| | | | H | W | D |
| One-Way 60 Degree Post Extension - Slotted - Aluminum Trim | EVP6CEPSA106 | 90 | 6 | 3.65 | |
| | EVP6CEPSA112 | 90 | 12 | 3.65 | |
| | EVP6CEPSA118 | 112 | 18 | 3.65 | |
| | EVP6CEPSA124 | 112 | 24 | 3.65 | |

EVP4CEPS2 - TWO-WAY 45 DEGREE POST EXTENSION - SLOTTED - ALUMINUM TRIM

- Connects two extension modules in a 135 degree configuration.
- Provides slotted support for worksurfaces and hang-on storage, up to 66"H.
- Includes one post, two slotted inline extension connectors, connecting hardware and trim kit.

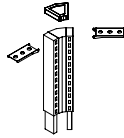
| | DESCRIPTION | PRODUCT CODE | LIST PRICE | DIMENSIONS/INCHES | | |
|---|--|--------------|------------|-------------------|------|---|
| | | | | H | W | D |
|  | Two-Way 45 Degree Post Extension - Slotted - Aluminum Trim | EVP4CEPS206 | 92 | 6 | 3.65 | |
| | | EVP4CEPS212 | 92 | 12 | 3.65 | |
| | | EVP4CEPS218 | 142 | 18 | 3.65 | |
| | | EVP4CEPS224 | 142 | 24 | 3.65 | |

EVP4CEPSA1 - ONE-WAY 45 DEGREE POST EXTENSION - SLOTTED - ALUMINUM TRIM

- Connects at the end of a run of extension modules in a 135 degree configuration.
- Provides slotted support for worksurfaces and hang-on storage, up to 66"H.
- Should not be used to attach a panel to a fixed wall.
- Includes one post, one slotted inline extension connector, connecting hardware and trim kit.

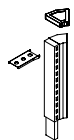
| | DESCRIPTION | PRODUCT CODE | LIST PRICE | DIMENSIONS/INCHES | | |
|---|--|--------------|------------|-------------------|------|---|
| | | | | H | W | D |
|  | One-Way 45 Degree Post Extension - Slotted - Aluminum Trim | EVP4CEPSA106 | 90 | 6 | 3.65 | |
| | | EVP4CEPSA112 | 90 | 12 | 3.65 | |
| | | EVP4CEPSA118 | 112 | 18 | 3.65 | |
| | | EVP4CEPSA124 | 112 | 24 | 3.65 | |

EVHCBP01 - CEILING BRACKET FOR POST

- Used to secure corner post to ceiling deck (not ceiling grid).
- Note: Care should be taken to attach ceiling brackets to secure ceiling using correct fasteners. Failure to do so may result in collapse of unit and subsequent possible injury
- 4.8" x 4.8" top plate with 1.5 x 1.5 square tube 12" H , square tube fits inside aluminum Corner Post.
- Square tube can slide in post , bracket pushed to ceiling to be secured.

| | DESCRIPTION | PRODUCT CODE | LIST PRICE | DIMENSIONS/INCHES | | |
|---|--------------------------|--------------|------------|-------------------|-----|-----|
| | | | | H | W | D |
|  | Ceiling Bracket for Post | EVHCBP01 | 73 | 12 | 4.8 | 4.8 |

EVHCBIC01 - CEILING BRACKET FOR INLINE CONNECTOR

- Used to secure corner post to ceiling deck (not ceiling grid).
- Note: Care should be taken to attach ceiling brackets to secure ceiling using correct fasteners. Failure to do so may result in collapse of unit and subsequent possible injury
- 4.8" x 4.8" top plate with 7.5"H insert in middle of plate, insert fits inside Inline Connector.
- 7.5" H insert can slide in connector , bracket pushed to ceiling to secure.

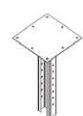
| | DESCRIPTION | PRODUCT CODE | LIST PRICE | DIMENSIONS/INCHES | | |
|---|--------------------------------------|--------------|------------|-------------------|-----|-----|
| | | | | H | W | D |
|  | Ceiling Bracket for Inline Connector | EVHCBP01 | 73 | 7.5 | 4.8 | 4.8 |



EVHCBER01 - CEILING BRACKET FOR END OF RUN CONNECTOR

- Used to secure corner post to ceiling deck (not ceiling grid).
- 4.8" x 4.8" top plate with 7.5"H insert offset from center of plate, insert fits inside End-of-Run or Inline Connector.
- 7.5" H insert can slide in connector, bracket pushed to ceiling to secure.
- Note: Care should be taken to attach ceiling brackets to secure ceiling using correct fasteners. Failure to do so may result in collapse of unit and subsequent possible injury

| DESCRIPTION | PRODUCT CODE | LIST PRICE | DIMENSIONS/INCHES | | |
|--------------------------------------|--------------|------------|-------------------|-----|-----|
| | | | H | W | D |
| Ceiling Bracket for Inline Connector | EVHCBER01 | 73 | 7.5 | 4.8 | 4.8 |

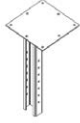

EVPUETA - UPMOUNT EXTENSION TRIM - ALUMINUM

- Finishes the exposed connector above a shorter panel.
- Slotted connector not included.

| DESCRIPTION | PRODUCT CODE | LIST PRICE | DIMENSIONS/INCHES | | |
|-----------------------------------|--------------|------------|-------------------|-------|---|
| | | | H | W | D |
| Upmount Extension Trim - Aluminum | EVPUETA12 | 49 | 12 | 2 7/8 | |

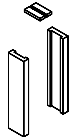

EVPERTA - END-OF-RUN TRIM - ALUMINUM

- Finishes the exposed Connector at the end of a run.
- Slotted Connector not included.
- Please note that actual cut sizes are nominally smaller than quoted

| DESCRIPTION | PRODUCT CODE | LIST PRICE | DIMENSIONS/INCHES | | |
|----------------------------|--------------|------------|-------------------|-------|---|
| | | | H | W | D |
| End-of-Run Trim - Aluminum | EVPERTA30 | 54 | 30 | 2 7/8 | |
| | EVPERTA42 | 73 | 42 | 2 7/8 | |
| | EVPERTA48 | 77 | 48 | 2 7/8 | |
| | EVPERTA54 | 82 | 54 | 2 7/8 | |
| | EVPERTA66 | 91 | 66 | 2 7/8 | |
| | EVPERTA72 | 96 | 72 | 2 7/8 | |
| | EVPERTA78 | 101 | 78 | 2 7/8 | |
| | EVPERTA84 | 104 | 84 | 2 7/8 | |
| | EVPERTA90 | 104 | 90 | 2 7/8 | |

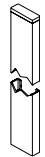

EVPLERTA - END-OF-RUN TRIM FOR LIGHT PANELS - ALUMINUM

- Finishes the exposed Connector at the end of a run of the Light Panels.
- Slotted Connector not included.
- Please note that actual cut sizes are nominally smaller than quoted

| DESCRIPTION | PRODUCT CODE | LIST PRICE | DIMENSIONS/INCHES | | |
|---|--------------|------------|-------------------|-------|---|
| | | | H | W | D |
| End-of-Run Trim for Light Panels - Aluminum | EVPLERTA30 | 55 | 26 1/4 | 2 7/8 | |
| | EVPLERTA42 | 64 | 38 1/4 | 2 7/8 | |
| | EVPLERTA48 | 73 | 44 1/4 | 2 7/8 | |
| | EVPLERTA54 | 85 | 50 1/4 | 2 7/8 | |
| | EVPLERTA66 | 91 | 62 1/4 | 2 7/8 | |
| | EVPLERTA72 | 94 | 68 1/4 | 2 7/8 | |
| | EVPLERTA78 | 97 | 74 1/4 | 2 7/8 | |
| | EVPLERTA84 | 102 | 80 1/4 | 2 7/8 | |
| | EVPLERTA90 | 108 | 86 1/4 | 2 7/8 | |

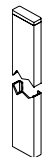

EVPTVA - PANEL TRIM - VARIABLE HEIGHT -ALUMINUM

- Attaches to the exposed end of the taller panel when 2 panels of different height meet in straight run.
- Slotted Connector not included.
- Please note that actual cut sizes are nominally smaller than quoted

| DESCRIPTION | PRODUCT CODE | LIST PRICE | DIMENSIONS/INCHES | | |
|---|--------------|------------|-------------------|-------|---|
| | | | H | W | D |
|  Panel Trim - Variable Height - Aluminum | EVPTVA06 | 21 | 6 | 2 7/8 | |
| | EVPTVA12 | 29 | 12 | 2 7/8 | |
| | EVPTVA18 | 36 | 18 | 2 7/8 | |
| | EVPTVA24 | 48 | 24 | 2 7/8 | |
| | EVPTVA30 | 55 | 30 | 2 7/8 | |
| | EVPTVA36 | 64 | 36 | 2 7/8 | |

EVPTVA - PANEL TRIM - VARIABLE HEIGHT -ALUMINUM

- Attaches to bottom of exposed end of panel to provide extension for End-of-Run post trim kit when using panel extensions.
- Does not include slotted connector nor connecting hardware.
- Please note that actual cut sizes are nominally smaller than quoted

| DESCRIPTION | PRODUCT CODE | LIST PRICE | DIMENSIONS/INCHES | | |
|---|--------------|------------|-------------------|-------|---|
| | | | H | W | D |
|  Panel Extension Trim - Aluminum | EVPTVA12 | 27 | 12 | 2 7/8 | |
| | EVPTVA18 | 36 | 18 | 2 7/8 | |
| | EVPTVA24 | 46 | 24 | 2 7/8 | |

EVPTVA - FLAT TRIM - ALUMINUM

- To be used with 30"H posts as a replacement trim.
- For "U" trim configuration use three flat trim according to height specifications.
- For "L" trim configuration use two flat trim according to height configurations.
- Please note that actual cut sizes are nominally smaller than quoted

| DESCRIPTION | PRODUCT CODE | LIST PRICE | DIMENSIONS/INCHES | | |
|--|--------------|------------|-------------------|-------|---|
| | | | H | W | D |
|  Flat Trim - Aluminum | EVPTVA30 | 17 | 29 1/8 | 2 7/8 | |
| | EVPTVA36 | 18 | 34 1/8 | 2 7/8 | |
| | EVPTVA42 | 21 | 41 1/8 | 2 7/8 | |
| | EVPTVA48 | 27 | 47 1/8 | 2 7/8 | |
| | EVPTVA54 | 27 | 53 1/8 | 2 7/8 | |
| | EVPTVA66 | 29 | 65 1/8 | 2 7/8 | |
| | EVPTVA72 | 42 | 72 1/8 | 2 7/8 | |
| | EVPTVA78 | 30 | 77 1/8 | 2 7/8 | |
| | EVPTVA84 | 33 | 83 1/8 | 2 7/8 | |
| | EVPTVA90 | 31 | 89 1/8 | 2 7/8 | |
| | EVPTVA96 | 35 | 95 1/8 | 2 7/8 | |



EVPVTFEA - FLAT EXTENSION TRIM - ALUMINUM

- Finishes exposed faces of One-Way, Two-Way, Three-Way and Inline Panels.
- For reconfiguration and replacement use only.
- For "U" trim configuration use three flat trim according to height specification.
- For "L" trim configuration use two flat trim according to height specification.
- Aluminum Trim must be specified when using premium color paints.
- Please note that actual cut sizes are nominally smaller than quoted

| | DESCRIPTION | PRODUCT CODE | LIST PRICE | DIMENSIONS/INCHES | | |
|---|--------------------------------|--------------|------------|-------------------|-------|---|
| | | | | H | W | D |
|  | Flat Extension Trim - Aluminum | EVPVTFEA06 | 16 | 12 3/8 | 2 7/8 | |
| | | EVPVTFEA12 | 16 | 12 3/8 | 2 7/8 | |
| | | EVPVTFEA18 | 18 | 18 3/8 | 2 7/8 | |
| | | EVPVTFEA24 | 18 | 24 3/8 | 2 7/8 | |
| | | EVPVTFEA30 | 21 | 30 3/8 | 2 7/8 | |
| | | EVPVTFEA36 | 27 | 36 3/8 | 2 7/8 | |
| | | EVPVTFEA42 | 28 | 42 3/8 | 2 7/8 | |
| | | EVPVTFEA48 | 29 | 48 3/8 | 2 7/8 | |
| | | EVPVTFEA54 | 30 | 54 3/8 | 2 7/8 | |
| | | EVPVTFEA66 | 33 | 66 3/8 | 2 7/8 | |
| | | EVPVTFEA72 | 35 | 72 3/8 | 2 7/8 | |
| | | EVPVTFEA78 | 35 | 78 3/8 | 2 7/8 | |
| | | EVPVTFEA84 | 44 | 84 3/8 | 2 7/8 | |
| | | EVPVTFEA90 | 46 | 90 3/8 | 2 7/8 | |
| | EVPVTFEA96 | 48 | 96 3/8 | 2 7/8 | | |

EVPLVTFA - FLAT TRIM FOR LIGHT PANELS - ALUMINUM

- Finishes exposed faces of One-Way, Two-Way, Three-Way and Inline Panels.
- For reconfiguration and replacement use only.
- For "U" trim configuration use three flat trim according to height specification.
- For "L" trim configuration use two flat trim according to height specification.
- Aluminum Trim must be specified when using premium color paints.
- Please note that actual cut sizes are nominally smaller than quoted

| | DESCRIPTION | PRODUCT CODE | LIST PRICE | DIMENSIONS/INCHES | | |
|---|---------------------------------------|--------------|------------|-------------------|-------|---|
| | | | | H | W | D |
|  | Flat Trim for Light Panels - Aluminum | EVPLVTFA30 | 17 | 26 1/4 | 2 7/8 | |
| | | EVPLVTFA42 | 21 | 38 1/4 | 2 7/8 | |
| | | EVPLVTFA48 | 27 | 44 1/4 | 2 7/8 | |
| | | EVPLVTFA54 | 27 | 50 1/4 | 2 7/8 | |
| | | EVPLVTFA66 | 29 | 62 1/4 | 2 7/8 | |
| | | EVPLVTFA72 | 29 | 68 1/4 | 2 7/8 | |
| | | EVPLVTFA78 | 30 | 74 1/4 | 2 7/8 | |
| | | EVPLVTFA84 | 30 | 80 1/4 | 2 7/8 | |
| | | EVPLVTFA90 | 31 | 86 1/4 | 2 7/8 | |

EVPTTA - PANEL TOP TRIM - ALUMINUM - FIELD INSTALLED

- This trim can span an Inline Connector, but not a Post Connector.
- Please note that actual cut sizes are nominally smaller than quoted

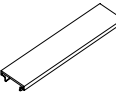
| | DESCRIPTION | PRODUCT CODE | LIST PRICE | DIMENSIONS/INCHES | | |
|---|---------------------------|--------------|------------|-------------------|-------|---|
| | | | | H | W | D |
|  | Panel Top Trim - Aluminum | EVPTTA18F | 16 | 18 | 2 7/8 | |
| | | EVPTTA24F | 21 | 24 | 2 7/8 | |
| | | EVPTTA30F | 28 | 30 | 2 7/8 | |
| | | EVPTTA36F | 30 | 36 | 2 7/8 | |
| | | EVPTTA42F | 36 | 42 | 2 7/8 | |
| | | EVPTTA48F | 46 | 48 | 2 7/8 | |
| | | EVPTTA54F | 53 | 54 | 2 7/8 | |
| | | EVPTTA60F | 58 | 60 | 2 7/8 | |
| | | EVPTTA66F | 64 | 66 | 2 7/8 | |
| | | EVPTTA72F | 70 | 72 | 2 7/8 | |
| | | EVPTTA78F | 77 | 78 | 2 7/8 | |
| | | EVPTTA84F | 85 | 84 | 2 7/8 | |
| | | EVPTTA90F | 90 | 90 | 2 7/8 | |

EVPTTA96F 97 96 2 7/8

EVPTNTA - PANEL TOP SINGLE NOTCHED TRIM - ALUMINUM - FIELD INSTALLED

- Used when connecting a lower Panel to a higher Panel
- This trim can span an Inline Connector, but not a Post Connector.
- Please note that actual cut sizes are nominally smaller than quoted

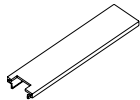
| DESCRIPTION | PRODUCT CODE | LIST PRICE | DIMENSIONS/INCHES | | |
|---|--------------|------------|-------------------|-------|---|
| | | | H | W | D |
|  Panel Top Singled Notched Trim - Aluminum | EVPTNTA18F | 18 | 18 | 2 7/8 | |
| | EVPTNTA24F | 25 | 24 | 2 7/8 | |
| | EVPTNTA30F | 28 | 30 | 2 7/8 | |
| | EVPTNTA36F | 30 | 36 | 2 7/8 | |
| | EVPTNTA42F | 35 | 42 | 2 7/8 | |
| | EVPTNTA48F | 48 | 48 | 2 7/8 | |
| | EVPTNTA54F | 54 | 54 | 2 7/8 | |
| | EVPTNTA60F | 61 | 60 | 2 7/8 | |
| | EVPTNTA66F | 65 | 66 | 2 7/8 | |
| | EVPTNTA72F | 70 | 72 | 2 7/8 | |
| | EVPTNTA78F | 75 | 78 | 2 7/8 | |
| | EVPTNTA84F | 82 | 84 | 2 7/8 | |
| | EVPTNTA90F | 86 | 90 | 2 7/8 | |
| | EVPTNTA96F | 90 | 96 | 2 7/8 | |

EVPTDNTA - PANEL TOP DOUBLE NOTCHED TRIM - ALUMINUM - FIELD INSTALLED

- Used when connecting a lower Panel to a higher Panel
- This trim can span an Inline Connector, but not a Post Connector.
- Please note that actual cut sizes are nominally smaller than quoted

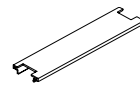
| DESCRIPTION | PRODUCT CODE | LIST PRICE | DIMENSIONS/INCHES | | |
|---|--------------|------------|-------------------|-------|---|
| | | | H | W | D |
|  Panel Top Double Notched Trim - Aluminum | EVPTDNTA18F | 21 | 18 | 2 7/8 | |
| | EVPTDNTA24F | 28 | 24 | 2 7/8 | |
| | EVPTDNTA30F | 30 | 30 | 2 7/8 | |
| | EVPTDNTA36F | 33 | 36 | 2 7/8 | |
| | EVPTDNTA42F | 36 | 42 | 2 7/8 | |
| | EVPTDNTA48F | 49 | 48 | 2 7/8 | |
| | EVPTDNTA54F | 55 | 54 | 2 7/8 | |
| | EVPTDNTA60F | 64 | 60 | 2 7/8 | |
| | EVPTDNTA66F | 69 | 66 | 2 7/8 | |
| | EVPTDNTA72F | 74 | 72 | 2 7/8 | |
| | EVPTDNTA78F | 81 | 78 | 2 7/8 | |
| | EVPTDNTA84F | 60 | 87 | 2 7/8 | |
| | EVPTDNTA90F | 88 | 90 | 2 7/8 | |
| | EVPTDNTA96F | 92 | 96 | 2 7/8 | |

EVSC12 - SLOT COVER

- Covers the slots of a slotted connector between modules as well as corner post situation.
- Available in all standard colors (Black, Charcoal Silver, Taupe, Tungsten, White and Nevada)
- Sold per foot. The desired quantity of the slot covers is the required length in feet.
- An easy way to calculate the required length is to sum the length of all inline connectors used in a project (including the posts) and multiply by 2.
- Should be field cut to required length.

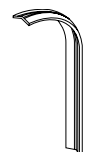
| DESCRIPTION | PRODUCT CODE | LIST PRICE | DIMENSIONS/INCHES | | |
|--|--------------|------------|-------------------|---|---|
| | | | H | W | D |
|  Slot Cover | EVSC12 | 9 | | | |



electrical

STEP-BY-STEP SPECIFICATION – 8-WIRE ELECTRICAL SYSTEM

Step 1 Determine the location of the source power entering the Panel Run.

1. At the base of the Panel.
 - (a) Use EVE8FR1 Reversible Floor Power Entry (default to EVE8FR1).
 - (b) Select the Panel to which the Floor Power Entry will be attached. This Panel requires an EVEPD Power Distribution Housing.
 - (c) Select the side of the Panel and the receptacle outlet to which the Floor Power Entry is to be attached.
2. From the ceiling.
 - (a) Use EVE8EC1 Ceiling Power Entry.
 - (b) Select the post through which to feed the Ceiling Power Entry.
 - (c) One Panel adjacent to the selected post requires an EVEPD Power Distribution Housing.
 - (d) Attach Ceiling Power entry to the nearest end of the Power Distribution Housing.

Step 2 Determine which Panels are to be powered.

1. Use EVE8PD Power Distribution Housing that corresponds with the width of the Panel.

Step 3 Connect power to the powered Panels.

1. Use EVE8CP16 Jumper Cable between two adjacent powered Panels, separated by an Inline Connector.
2. Use EVE8CP18 Jumper Cable between two adjacent powered Panels separated by a post.
3. Use EVE8CP Pass-Through Cables to connect powered Panels that are separated by one or more non-powered Panels (maximum distance between the powered Panels is 16 feet).
 - (a) The length of the Pass-Through Cable is calculated by adding together the widths of the non-powered Panels (that separate the two powered Panels) and applying an additional 16" to the total. (EVE8PD Power Distribution Housing is positioned 8" in from the ends of the powered Panel.)
 - (b) An additional 3" must be added to the Pass-Through Cable for each post that the cable passes through.
4. From the price list, select the EVE8CP Pass-Through Cable that matches the calculated length. If the length is between listed sizes, use the next size up.

Step 4 Determine the location and circuitry of the receptacles.

1. Each powered Panel has four (4) potential locations for EVE8RD Duplex Receptacles – 2 per side. (Exception: 24" wide Panel has only two potential locations – 1 per side, 18" wide Panel has no locations for receptacles.)
2. At each receptacle location there is a choice of four circuit options. Select a circuit option for each location. Circuits one & two are utility circuits; circuits A & B are dedicated circuits.

BELTLINE TIPS:

DO - use a 17" long Mesh Beltline Jumper when making 90 degree turns in the Beltline raceways only.

DO NOT - use a 20" long Metal Flex Jumper when attempting to make 90 degree turns in the Beltline Raceways. The end connector is too long to make the turn.

DO - use a 20" long Metal Flex Jumper when traveling through a Beltline Post, in a straight line only.

DO NOT - use a 17" long Mesh Beltline Jumper Traveling through a Beltline Post, in a straight line only. The Jumper is too short to make the connection.

EVOLVE'S MODIFIED 8-WIRE ELECTRICAL SYSTEM

Evolve has modified its 8-Wire Electrical System to stay abreast of changing industry standards.

Evolve's electrical system allows for the integration of the commonly required "2+2" configuration (2 utility circuits, 2 dedicated circuits) found in the source power of most of today's North American buildings.

This system is rated for connection to:

1. A grounded 120/240V, single phase, 20 A, 60Hz
2. A 120/208V, 3 phase, 20 A, 60Hz branch circuit

EQUIPMENT AMPERAGE

| | |
|-------------------------------------|--------------|
| Calculator | 0.25 |
| Electric Eraser | 0.50 |
| Pencil Sharpener | 1.00 |
| Radio | 0.05 |
| Paper Shredder..... | 4.40 - 13.00 |
| Electric Typewriter | 1.20 |
| Personal Computer..... | 2.00 - 4.00 |
| Video Display Terminal | 0.08 |
| Draft / Letter Quality Printer..... | 1.20 - 3.00 |

Data/Comm

Evolve's duplex receptacle openings will now conform to the ANSI/TIA/EIA Furniture Opening Standard of 1.38 +/- .035 x 2.71 +/- .04. There will no longer be the need to use adapter plates to reduce the size of Evolve's raceway opening, or to use Evolve dedicated data plates for data/comm terminations.

Transition

A transition cable is available to connect the previous electrical system prior to April 1, 2005 to the current system when adding Panels to an existing installation. Also, new raceway covers with the smaller openings can be provided and applied to existing Panels when retrofitted with new electrics.

| | |
|-----------------------------|--------------|
| Fan..... | 1.00 |
| Heater..... | 8.50 - 12.50 |
| Coffee Pot..... | 15.00 |
| Task Light | 1.00 |
| Slide Projector..... | 2.00 - 6.00 |
| Laser Printer | 5.00 - 8.00 |
| Processor / Disk Unit | 1.00 - 10.00 |
| Desk Top Plotter | 1.50 |

Some equipment, such as large copiers, printers, plotters, heaters and coffee makers may occupy most of the circuit capacity. It is recommended that such devices be supplied with the power directly from the wall or building receptacle.



WIRING SCHEMATIC

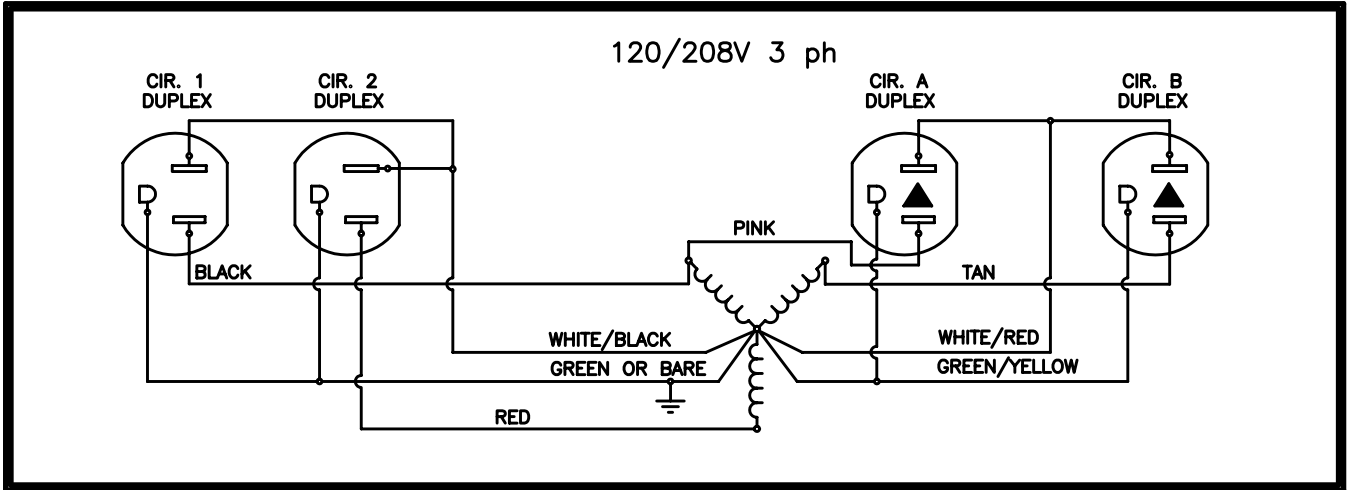
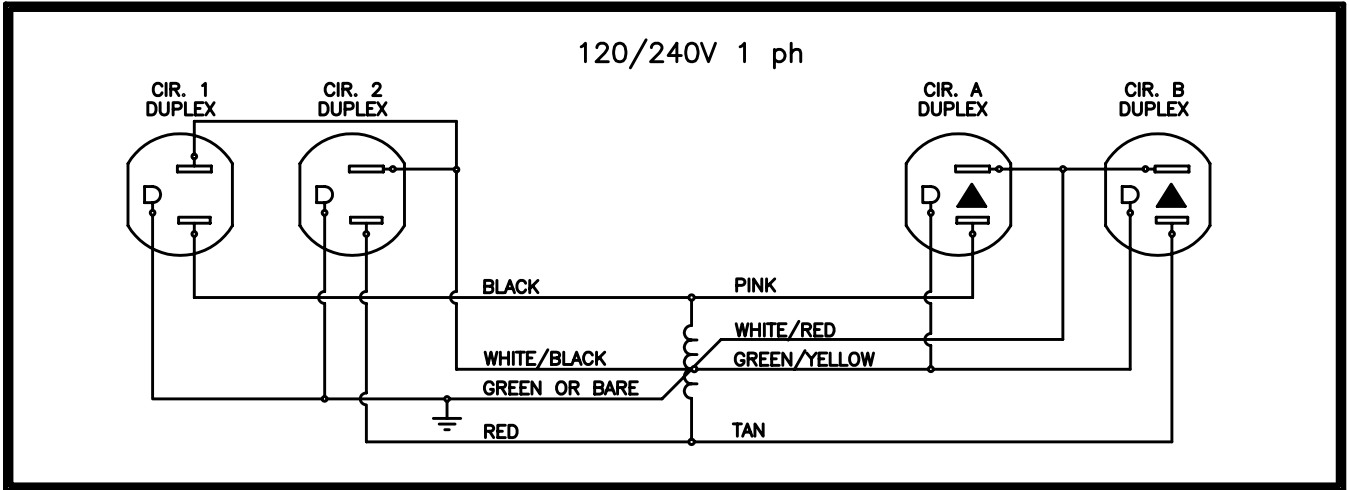

DEFINING “2 + 2” WIRING CONFIGURATIONS

2 + 2 Configuration (8 wire, 4 circuit)

Two Utility Circuits [Evolve’s #1 & #2 circuits] share one neutral wire and one ground wire.
(2 hot [circuit] wires + 1 neutral wire*** + 1 green ground wire* = 4 wires)

Two Dedicated Circuits [Evolve’s “A” & “B” circuits] share one neutral wire and one ground wire.
(2 hot [circuit] wires + 1 neutral wire*** + 1 green/yellow ground wire** = 4 wires)

NOTE:

It is the ground wire that makes the difference between “Utility” and “Dedicated” circuits. Refer to Wiring Schematics found in the Price List.

* A Green ground wire is a “system” ground. This means it could be grounded to any piece of metal, including the Panel.

** A Green/Yellow ground wire is isolated, within the wiring conduit, all the way back to the box at the source (building ground).

*** All Neutral Wires are 10 gauge rather than 12 gauge meaning they are larger than normal, allowing greater protection against “noise” or interference on the circuit.

This page provides an exploded view of a sample configuration highlighting each **Electrical** component required when specifying this configuration.

Components

- A.** EVE8PD42 Power Distribution Housing
Note: 8 wire, 4 circuits (3rd/4th circuits dedicated) labeled A or B.
- B.** EVE8CP16 Jumper Cable
Note: EVE8CP16 connects two powered panels positioned side by side, separated by an Inline Connector
EVE8CP18 connects two powered panels separated by a post.
- C.** EVE8RD Duplex Receptacle
- D.** EVE8CP Pass-Through Cable
Note: Pass-Through Extension Cable (EVE8CPF154) available – extends power capability beyond 208".

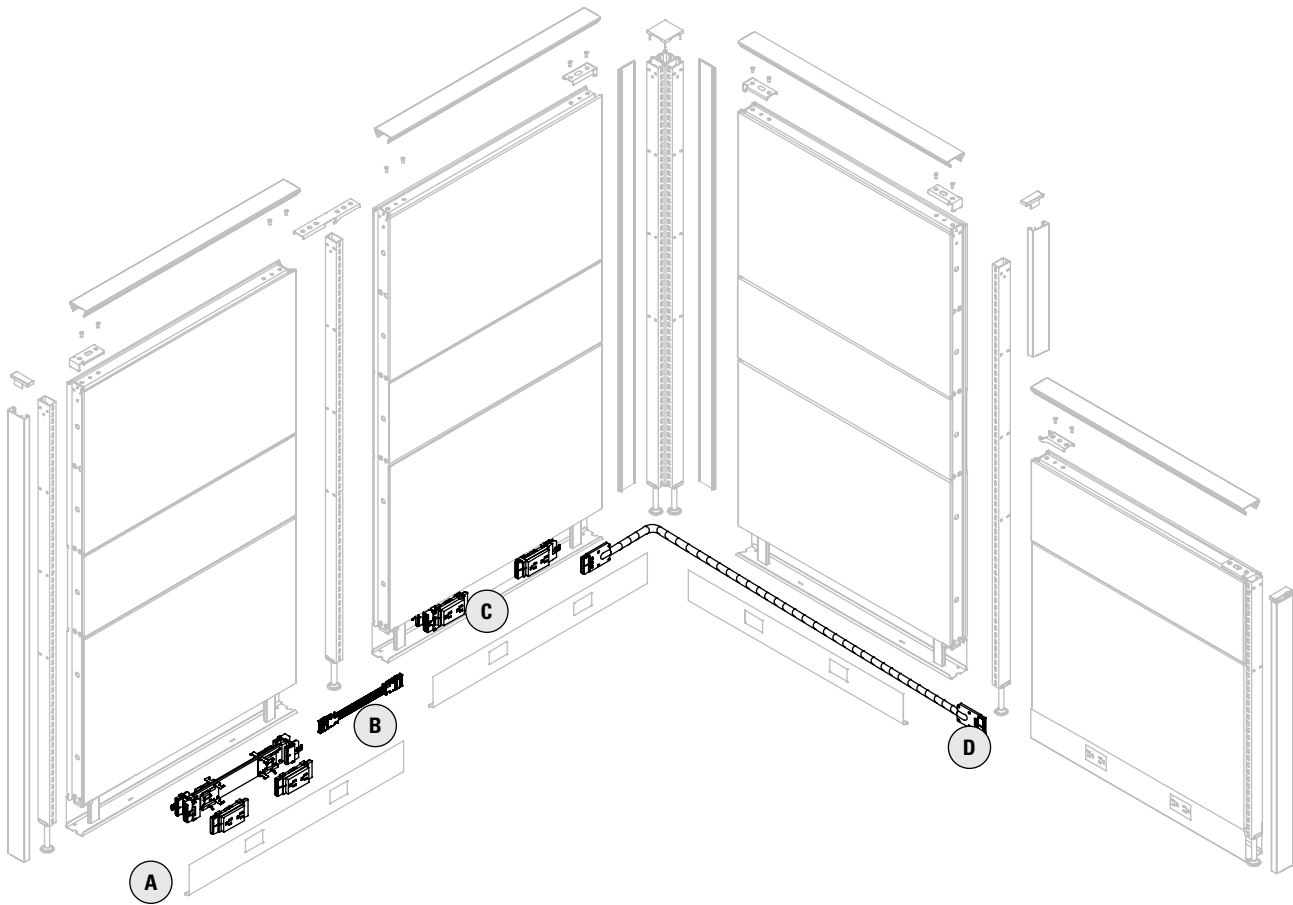

This page provides an exploded view of a sample configuration highlighting each **Beltline Power Panel** component required when specifying this configuration.

- | | |
|---|---|
| <p>A. EVE8PD36 Power Distribution Housing Note: 8 wire, 4 circuits (3rd/4th circuits dedicated) labeled A or B.</p> <p>B. EVE8CP17 Jumper Cable Note: EVE8CP17 connects two powered panels positioned side by side, separated by an Inline Connector</p> <p>C. EVE8RD Duplex Receptacle</p> <p>D. EVE8CP Pass-Through Cable Note: Pass-Through Extension Cable (EVE8CPF154) available – extends power capability beyond 208".</p> | <p>E. EVE8CP18 Jumper Cable Note: EVE8CP18 connects two powered panels separated by a post, in a straight line.</p> <p>F. EVE8CP17 Jumper Cable Note: EVE8CP17 connects two powered panels separated by a post, for turns through post.</p> <p>G. EVE8CPCP Base to Belt Pass Through Kit Note: For use in Chimney Panels only.</p> |
|---|---|

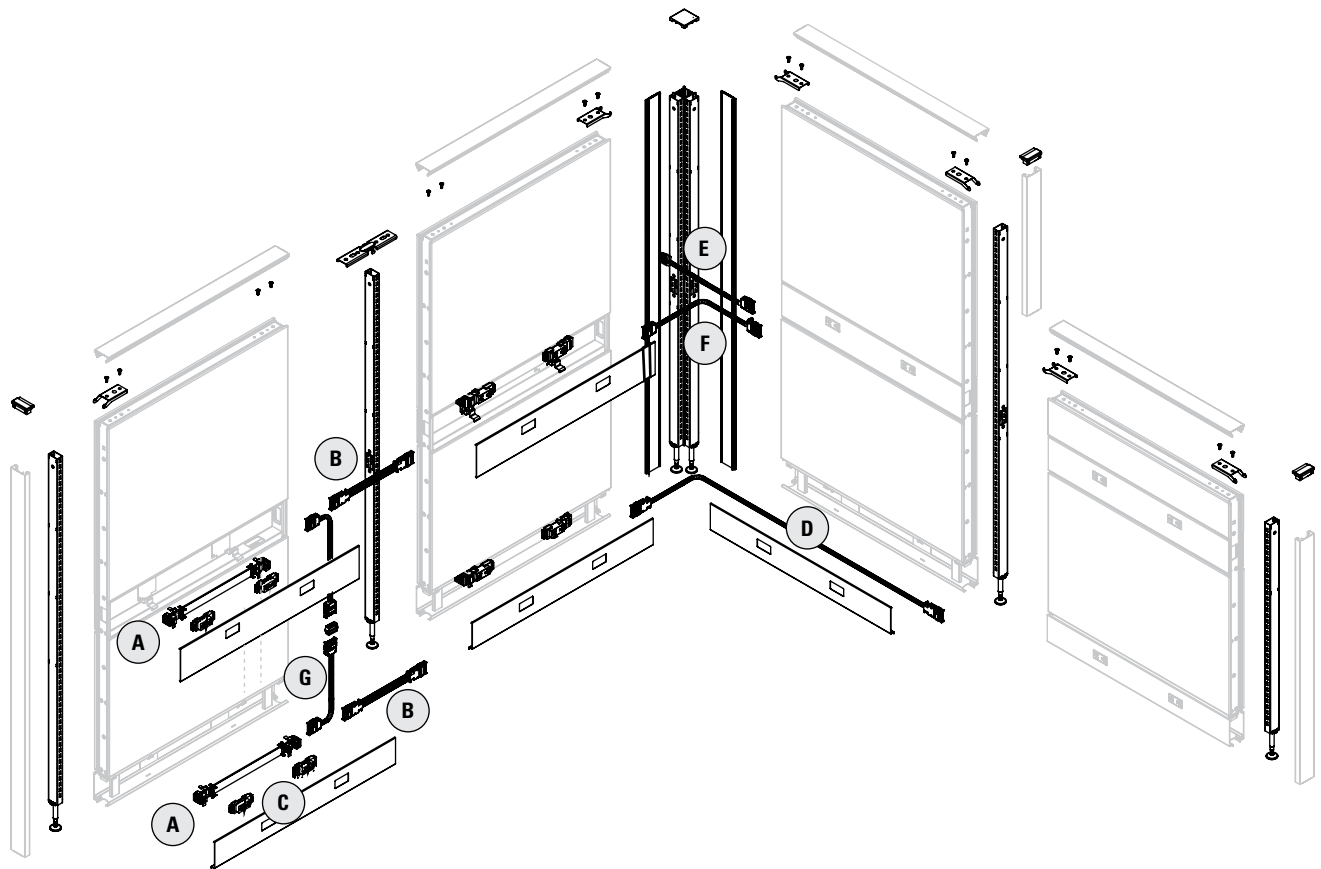

ELECTRICAL

EVE8PD - POWER DISTRIBUTION HOUSING

- Power housing is specified per panel size (e.g. EVE8PD36 is for use in a 36" panel).
- 8 wire, 4 circuits (2+2 configuration).
- Provides two duplex receptacles per panel side on all panel widths except the 24" wide panel.
- 24" wide panel allows for only one (1) duplex receptacle per panel side.
- Each power distribution housing supports 15-20 amps.

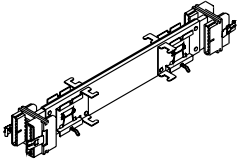
| DESCRIPTION | PRODUCT CODE | LIST PRICE | DIMENSIONS/INCHES | | |
|--|--------------|------------|-------------------|--------|---|
| | | | H | L | D |
|  Power Distribution Housing | EVE8PD24 | 163 | | 6 1/4 | |
| | EVE8PD30 | 220 | | 11 1/2 | |
| | EVE8PD36 | 231 | | 17 1/2 | |
| | EVE8PD42 | 237 | | 23 1/2 | |
| | EVE8PD48 | 257 | | 29 1/2 | |
| | EVE8PD54 | 258 | | 39 1/4 | |
| | EVE8PD60 | 259 | | 41 1/2 | |

EVE8CP16 - JUMPER CABLE

- The EVE8CP16 electrically connects two powered panels positioned side by side, separated by an Inline connector.

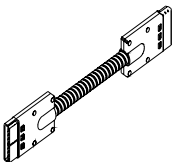
| DESCRIPTION | PRODUCT CODE | LIST PRICE | DIMENSIONS/INCHES | | |
|--|--------------|------------|-------------------|----|---|
| | | | H | L | D |
|  Jumper Cable | EVE8CP16 | 136 | | 16 | |

EVE8CP - FLEXIBLE MESH JUMPER CABLE

- Used to connect two power distribution housings at the beltline level at 90 degrees.
- 18.5" flexible mesh jumper replaces EVE8CP20 jumper for corner post applications.

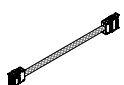
| DESCRIPTION | PRODUCT CODE | LIST PRICE | DIMENSIONS/INCHES | | |
|--|--------------|------------|-------------------|--------|---|
| | | | H | L | D |
|  Flexible Mesh Jumper Cable | EVE8CP17 | 126 | | 17 1/2 | |
| | EVE8CP18 | 156 | | 18 1/2 | |

EVE8PCP - CHIMNEY PANEL JUMPER CABLE KIT

- Contains two (2) 17" flexible harnesses and one (1) "I" connector.
- Used to connect electric from the base to the beltline raceway in Beltline Powered Chimney panel.
- Must use in conjunction with base power distribution harness and beltline power distribution harness (sold separately).

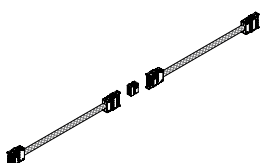
| DESCRIPTION | PRODUCT CODE | LIST PRICE | DIMENSIONS/INCHES | | |
|--|--------------|------------|-------------------|---|---|
| | | | H | L | D |
|  Chimney Panel Jumper Cable Kit | EVE8PCP | 341 | | | |

EVE8RD1



ELECTRICAL

EVE8CPXX-H - PASS-THROUGH CABLE

- Flexible metal conduit with wire mesh distributes electrical power through non-powered beams.
- To calculate the length of a Pass-Through Cable, add the widths of the non-powered panels separating the powered panels (panels with distribution housing attached). To this, add 16" (distance from the edge of the panel to the distribution housing x 2).
- Add additional 3" when passing through a post. See the Tips at the beginning of the section for more details.
- Hybrid pass-through cables with wire mesh allows connection at 90 degree post at one end for Evolve panels including Beltline and Power Beam

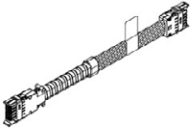
| | DESCRIPTION | PRODUCT CODE | LIST PRICE | DIMENSIONS/INCHES | | |
|---|--------------------|--------------|------------|-------------------|-----|---|
| | | | | H | L | D |
|  | Pass-Through Cable | EVE8CP40-H | 211 | | 40 | |
| | | EVE8CP46-H | 218 | | 46 | |
| | | EVE8CP52-H | 224 | | 52 | |
| | | EVE8CP58-H | 238 | | 58 | |
| | | EVE8CP64-H | 248 | | 64 | |
| | | EVE8CP70-H | 256 | | 70 | |
| | | EVE8CP76-H | 258 | | 76 | |
| | | EVE8CP82-H | 269 | | 82 | |
| | | EVE8CP88-H | 278 | | 88 | |
| | | EVE8CP94-H | 285 | | 88 | |
| | | EVE8CP100-H | 294 | | 100 | |
| | | EVE8CP106-H | 308 | | 106 | |
| | | EVE8CP118-H | 323 | | 118 | |
| | | EVE8CP130-H | 355 | | 130 | |
| | | EVE8CP142-H | 371 | | 142 | |
| | | EVE8CP154-H | 388 | | 154 | |
| | | EVE8CP172-H | 417 | | 172 | |
| | | EVE8CP190-H | 437 | | 190 | |
| | | EVE8CP208-H | 454 | | 208 | |

EVE8CI-1 - "I" CONNECTOR

- Female - Female connector used to connect two Pass-Through Cables

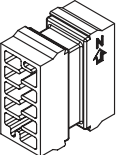
| | DESCRIPTION | PRODUCT CODE | LIST PRICE | DIMENSIONS/INCHES | | |
|---|---------------|--------------|------------|-------------------|---|---|
| | | | | H | W | D |
|  | "I" Connector | EVE8CI-1 | 94 | | | |

ELECTRICAL

EVE8RD - DUPLEX RECEPTACLE - 15 AMPS

- Duplex receptacles are rated for 15 Amps.
- EVE8RD1 = Circuit #1 (utility circuit)
- EVE8RD2 = Circuit #2 (utility circuit)
- EVE8RDA = Circuit A (dedicated)
- EVE8RDB = Circuit B (dedicated)

NOTE:

- EVE8RD1 and EVE8RD2 (#1 and #2 share common ground)
- EVE8RDA and EVE8RDB (A and B share common ground)
- Up to 6 receptacles per circuit (24 per infeed), not to exceed total of 15 Amps per circuit.
- Standard in black. Available in White or Nevada with upcharge.

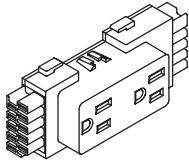
| DESCRIPTION | PRODUCT CODE | LIST PRICE | DIMENSIONS/INCHES | | |
|--|--------------|------------|-------------------|-------|-------|
| | | | H | W | D |
|  Duplex Receptacle | EVE8RD1 | 36 | 2 | 4 5/8 | 1 1/4 |
| | EVE8RD2 | 36 | 2 | 4 5/8 | 1 1/4 |
| | EVE8RDA | 36 | 2 | 4 5/8 | 1 1/4 |
| | EVE8RDB | 36 | 2 | 4 5/8 | 1 1/4 |
| | EVE8RD1SND | 41 | 2 | 4 5/8 | 1 1/4 |
| | EVE8RD2SND | 41 | 2 | 4 5/8 | 1 1/4 |
| | EVE8RDASND | 41 | 2 | 4 5/8 | 1 1/4 |
| | EVE8RDBSND | 41 | 2 | 4 5/8 | 1 1/4 |
| | EVE8RD1WHT | 41 | 2 | 4 5/8 | 1 1/4 |
| | EVE8RD2WHT | 41 | 2 | 4 5/8 | 1 1/4 |
| | EVE8DAWHT | 41 | 2 | 4 5/8 | 1 1/4 |
| | EVE8RDBWHT | 41 | 2 | 4 5/8 | 1 1/4 |

EVE8RD - DUPLEX RECEPTACLE - 20 AMPS

- Duplex receptacles are rated for 20 Amps.
- EVE8RD1-20 = Circuit #1 (utility circuit)
- EVE8RD2-20 = Circuit #2 (utility circuit)
- EVE8RDA-20 = Circuit #A (dedicated)
- EVE8RDB-20 = Circuit #B (dedicated)

NOTE:

- EVE8RD1-20 and EVE8RD2-20 (#1 and #2 share common ground)
- EVE8RDA-20 and EVE8RDB-20 (A and B share common ground)
- Up to 6 receptacles per circuit (24 per infeed) not to exceed total 20 Amps per circuit
- Standard in black. Available in White or Nevada with upcharge.

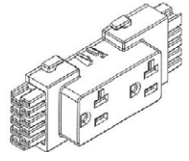
| DESCRIPTION | PRODUCT CODE | LIST PRICE | DIMENSIONS/INCHES | | |
|---|---------------|------------|-------------------|-------|-------|
| | | | H | W | D |
|  Duplex Receptacle 20 amps | EVE8RD1-20 | 56 | 2 | 4 5/8 | 1 1/4 |
| | EVE8RD2-20 | 56 | 2 | 4 5/8 | 1 1/4 |
| | EVE8RDA-20 | 56 | 2 | 4 5/8 | 1 1/4 |
| | EVE8RDB-20 | 56 | 2 | 4 5/8 | 1 1/4 |
| | EVE8RD1-20SND | 61 | 2 | 4 5/8 | 1 1/4 |
| | EVE8RD2-20SND | 61 | 2 | 4 5/8 | 1 1/4 |
| | EVE8RDA-20SND | 61 | 2 | 4 5/8 | 1 1/4 |
| | EVE8RDB-20SND | 61 | 2 | 4 5/8 | 1 1/4 |
| | EVE8RD1-20WHT | 61 | 2 | 4 5/8 | 1 1/4 |
| | EVE8RD2-20WHT | 61 | 2 | 4 5/8 | 1 1/4 |
| | EVE8RDA-20WHT | 61 | 2 | 4 5/8 | 1 1/4 |
| | EVE8RDB-20WHT | 61 | 2 | 4 5/8 | 1 1/4 |



ELECTRICAL

EVE8RDxca - CALIFORNIA CONTROLLED DUPLEX RECEPTACLE

- California Title 24 meets federal and LEED certification guidelines
- Allows circuit to be controlled or switched off when utility is not in use.
- Duplex receptacles are rated for 15 Amps.
- EVE8RD1CA = Circuit #1 (utility circuit)
- EVE8RD2CA = Circuit #2 (utility circuit)
- EVE8RDACA = Circuit A (dedicated)
- EVE8RDBCA = Circuit B (dedicated)

NOTE:

- EVE8RD1CA and EVE8RD2CA (#1 and #2 share common ground)
- EVE8RDACA and EVE8RDBCA (A and B share common ground)
- Up to 6 receptacles per circuit (24 per infeed), not to exceed total of 15 Amps per circuit.
- Available in BLK finish only.

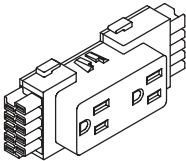
| | DESCRIPTION | PRODUCT CODE | LIST PRICE | DIMENSIONS/INCHES | | |
|---|-------------------|--------------|------------|-------------------|-------|-------|
| | | | | H | W | D |
|  | Duplex Receptacle | EVE8RD1CA | 39 | 2 | 4 5/8 | 1 1/4 |
| | | EVE8RD2CA | 39 | 2 | 4 5/8 | 1 1/4 |
| | | EVE8RDACA | 39 | 2 | 4 5/8 | 1 1/4 |
| | | EVE8RDBCA | 39 | 2 | 4 5/8 | 1 1/4 |

EVE8RD - DUPLEX RECEPTACLE TO CONVERT STANDARD 2 + 2 SYSTEM TO 3 + 1

- Duplex receptacle are rated for 15 Amps
- EVE8RDA-4 = Duplex receptacle A without triangle to be utility circuit
- EVE8RDB-4 = Duplex receptacle B without triangle to be utility circuit
- Up to 6 receptacles per circuit (24 per infeed) not to exude total 15 Amps per circuit
- Standard in black. Available in White or Nevada with upcharge.

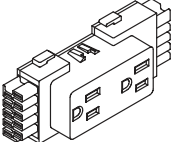
| | DESCRIPTION | PRODUCT CODE | LIST PRICE | DIMENSIONS/INCHES | | |
|--|-------------------|--------------|------------|-------------------|-------|-------|
| | | | | H | L | D |
|  | Duplex Receptacle | EVE8RDA-4 | 36 | 2 | 4 5/8 | 1 1/4 |
| | | EVE8RDB-4 | 36 | 2 | 4 5/8 | 1 1/4 |
| | | EVE8RDA-4SND | 41 | 2 | 4 5/8 | 1 1/4 |
| | | EVE8RDB-4WHT | 41 | 2 | 4 5/8 | 1 1/4 |
| | | EVE8RDA-4SND | 41 | 2 | 4 5/8 | 1 1/4 |
| | | EVE8RDA-4WHT | 41 | 2 | 4 5/8 | 1 1/4 |

EVEUSB01 - USB MODULE

- Includes two USB ports.
- Available in White and Black.

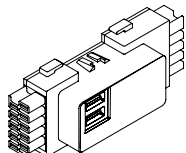
| | DESCRIPTION | PRODUCT CODE | LIST PRICE | DIMENSIONS/INCHES | | |
|---|--------------------|--------------|------------|-------------------|-------|-------|
| | | | | H | L | D |
|  | USB Module - White | EVEUSB01WHT | 226 | 2 | 4 5/8 | 1 1/4 |
| | USB Module - Black | EVEUSB01BLK | 226 | 2 | 4 5/8 | 1 1/4 |

ELECTRICAL

EVE8FR1 - REVERSIBLE FLOOR POWER ENTRY

- Takes the place of a duplex receptacle by snapping into the base power way or Beltline power way.
- Includes 72" long flexible vinyl conduit.
- Must be hard wired to source power by a licensed electrician.
- Diameter is 0.85"

EVE8FR2 - REVERSIBLE FLOOR POWER ENTRY

- Takes the place of a duplex receptacle by snapping into the base power way or Beltline power way.
- Includes 144" long flexible vinyl conduit.
- Must be hard wired to source power by a licensed electrician.
- Diameter is 0.85"

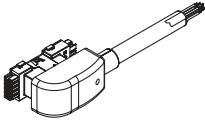
| | DESCRIPTION | PRODUCT CODE | LIST PRICE | DIMENSIONS/INCHES | | |
|---|------------------------------|--------------|------------|-------------------|-----|---|
| | | | | H | L | D |
|  | Reversible Floor Power Entry | EVE8FR1 | 367 | | 72 | |
| | | EVE8FR2 | 475 | | 144 | |

EVE8F - FLOOR POWER ENTRY

- Snaps in end of power distribution housing.
- Includes flexible vinyl conduit.

- Must be hard wired to source power by a licensed electrician.
- Diameter is 0.85"

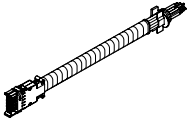
| | DESCRIPTION | PRODUCT CODE | LIST PRICE | DIMENSIONS/INCHES | | |
|---|-------------------|--------------|------------|-------------------|-----|---|
| | | | | H | L | D |
|  | Floor Power Entry | EVE8F1P | 356 | | 72 | |
| | | EVE8F2P | 460 | | 144 | |

VE8EC - CEILING POWER ENTRY

- Snaps into the end of a Power Distribution Housing.
- Flexible metal conduit extends into the ceiling through a corner post and post extension.
- Must be hard wired to source power by a licensed electrician.
- 4" junction box included.

- Post extension ordered separately
- Can feed directly into beltline power when Beltline Post Connectors are specified.
- Cannot feed through Inline or End-of-run Connectors.

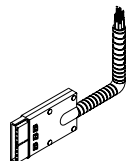
| | DESCRIPTION | PRODUCT CODE | LIST PRICE | DIMENSIONS/INCHES | | |
|---|---------------------|--------------|------------|-------------------|-----|---|
| | | | | H | L | D |
|  | Ceiling Power Entry | EVE8EC1 | 284 | | 132 | |
| | | EVE8EC2 | 497 | | 144 | |
| | | EVE8EC3 | 560 | | 180 | |

EVEENY-2 - HARDWARE POWER ENTRY BOX - NEW YORK

- A licensed electrician must provide hard wire connection within the junction box.
- Not for use in panels less than 36"W.

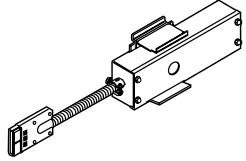
| | DESCRIPTION | PRODUCT CODE | LIST PRICE | DIMENSIONS/INCHES | | |
|---|-------------------------------------|--------------|------------|-------------------|----|-------|
| | | | | H | W | D |
|  | Hardware Power Entry Box - New York | EVEENY2 | 470 | 3 | 28 | 2 1/5 |



ELECTRICAL

EVEJBC-1 - HARDWARE JUNCTION BOX - CHICAGO

- Can be retrofitted in any size of panel at the receptacle location.
- Gives access from one side only at each location.
- Customer to supply conduit, wiring, receptacle, and face plate.
- 2 per panel, except 24" panels only one is needed.
- A licensed electrician must provide hardware connection with the junction box.

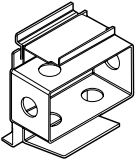
| | DESCRIPTION | PRODUCT CODE | LIST PRICE | DIMENSIONS/INCHES | | |
|---|---------------------------------|--------------|------------|-------------------|---|---|
| | | | | H | W | D |
|  | Hardware Junction Box - Chicago | EVEJBC-1 | 108 | | | |

EVDPE - POST EXTENSION DATA/COMM LAY-IN

- Attaches to the top of a post to bring power and/or data cables from the ceiling to the panel power way
- Three-sided power pole with snap-on fourth side.
- Post extension can be opened on one side for lay-in or power and/or data cables.
- Made of aluminum and can be field cut.
- Accommodates up to 25CAT 5 Cables with electric. Accommodates up to 45 CAT 5 Cables without electric.
- Actual size interior dimension of post, 1.80" x 1.80"

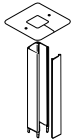
| | DESCRIPTION | PRODUCT CODE | LIST PRICE | DIMENSIONS/INCHES | | |
|---|---------------------------------|--------------|------------|-------------------|---|---|
| | | | | H | W | D |
|  | Post Extension Data/Comm Lay-in | EVDPE64 | 182 | 64 | 2 | |
| | | EVDPE82 | 220 | 82 | 2 | |

EVDP6E - 60° POST EXTENSION DATA/COMM LAY-IN

- Attaches to the top of a 60° corner post to bring power and/or data cables from the ceiling to the panel power way.
- Two-sided power pole with snap-on third side.
- Post extension can be opened on one side for lay-in or power and/or data cables.
- Made of aluminum and can be field cut.
- Accommodates up to 6 CAT 5 Cables with electric. Accommodates up to 20 CAT 5 Cables without electric.

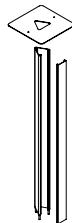
| | DESCRIPTION | PRODUCT CODE | LIST PRICE | DIMENSIONS/INCHES | | |
|---|-------------------------------------|--------------|------------|-------------------|---|---|
| | | | | H | W | D |
|  | 60° Post Extension Data/Comm Lay-in | EVDP6E64 | 182 | 64 | 2 | |
| | | EVDP6E82 | 220 | 82 | 2 | |

ELECTRICAL

EVDP4E - 45° POST EXTENSION DATA/COMM LAY-IN

- Attaches to the top of a 45° corner post to bring power and/or data cables from the ceiling to the panel power way.
- Two-sided power pole with snap-on third side.
- Post extension can be opened on one side for lay-in or power and/or data cables.
- Made of aluminum and can be field cut.
- Accommodates up to 6 CAT 5 Cables with electric. Accommodates up to 20 CAT 5 Cables without electric.

| DESCRIPTION | PRODUCT CODE | LIST PRICE | DIMENSIONS/INCHES | | |
|-------------------------------------|--------------|------------|-------------------|------|---|
| | | | H | W | D |
| 45° Post Extension Data/Comm Lay-in | EVDP4E64 | 190 | 64 | 3.65 | |
| | EVDP4E84 | 166 | 84 | 3.65 | |

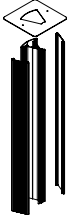

EVLEDES - STARTER LED TASK LIGHT

- Undercabinet slim profile LED linear light fixture with lens and On/Off switch.
- May be used as stand-alone or extended with add-on section below (EVLEDES_DSC).
- Plug-in power supply with 72" cord length plus 78" DC cable.
- Includes magnet mounting bracket with optional adhesive metal plate.
- Light enclosure in clear anodizing finish. Color temperature cool white 4000K.
- Lifespan rated 30,000 hours.

| DESCRIPTION | PRODUCT CODE | LIST PRICE | DIMENSIONS/INCHES | | |
|----------------|--------------|------------|-------------------|------|---|
| | | | H | W | D |
| Led Task Light | EVLEDES24 | 277 | 1 | 22.9 | 1 |
| | EVLEDES36 | 318 | 1 | 33.5 | 1 |
| | EVLEDES48 | 354 | 1 | 45.5 | 1 |

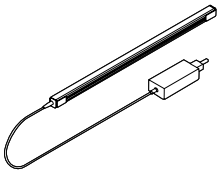

EVLEDES - ADD-ON LED TASK LIGHT

- Undercabinet slim profile LED linear add-on light fixture with lens.
- Daisy chain unit with 39" linking cable, no power supply.
- Add-on units can only be linked up to a total of 48 watts per power supply; this is equivalent to 10 feet of nominal length of light per power supply.
- Includes magnet mounting bracket with optional adhesive metal plate. Light enclosure in clear anodizing finish. Color temperature cool white 4000K. Lifespan rated 30,000 hours.

| DESCRIPTION | PRODUCT CODE | LIST PRICE | DIMENSIONS/INCHES | | |
|----------------|--------------|------------|-------------------|----|----|
| | | | H | W | D |
| Led Task Light | EVLEDES24DSC | 227 | 1 | 24 | 39 |
| | EVLEDES36DSC | 267 | 1 | 36 | 39 |
| | EVLEDES48DSC | 303 | 1 | 48 | 39 |

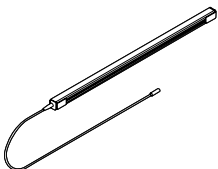

ELECTRICAL

EVELEDESOS - OCCUPANCY SENSOR

- Inline add-on controller for dimming and occupancy sensor.
- Sensor bypass switch.

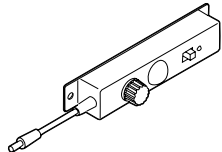
| | DESCRIPTION | PRODUCT CODE | LIST PRICE | DIMENSIONS/INCHES | | |
|---|------------------|--------------|------------|-------------------|-----|---|
| | | | | H | W | D |
|  | Occupancy Sensor | EVELEDESOS | 114 | 6 | 2.4 | 2 |

EVELEDVS - VOYAGE LED SINGLE LIGHT FIXTURE

- Single arm option with 6 ft. cord.
- Touch & hold dimming capability.
- Brightness adjustment from 100% to 15%.
- Available in Designer White (WHT), Black (BLK) or Silver (SIL).
- Mercury free LEDs and 94% post consumer recyclability by weight.
- Mounting accessories sold separately.

| | DESCRIPTION | PRODUCT CODE | LIST PRICE | DIMENSIONS/INCHES | | |
|---|--|--------------|------------|-------------------|---|---|
| | | | | H | W | D |
|  | Voyage LED Single Light Fixture | EVELEDVS | 763 | | | |
| | Voyage LED Single Light Fixture w/Occupancy Sensor | EVELEDVSO | 1130 | | | |

EVELEDVD - VOYAGE LED DOUBLE LIGHT FIXTURE

- Double arm option with 6 ft. cord.
- Touch & hold dimming capability.
- Brightness adjustment from 100% to 15%.
- Available in Designer White (WHT), Black (BLK) or Silver (SIL).
- Mercury free LEDs and 94% post consumer recyclability by weight.
- Mounting accessories sold separately.

| | DESCRIPTION | PRODUCT CODE | LIST PRICE | DIMENSIONS/INCHES | | |
|---|--|--------------|------------|-------------------|---|---|
| | | | | H | W | D |
|  | Voyage LED Double Light Fixture | EVELEDVD | 775 | | | |
| | Voyage LED Double Light Fixture w/Occupancy Sensor | EVELEDVDO | 1146 | | | |

EVELEDRS - REVO LED SINGLE LIGHT FIXTURE

- Single arm option with 9 ft. cord.
- Touch & hold dimming capability.
- Brightness adjustment from 100% to 15%.
- Available in Designer White (WHT), Black (BLK) or Silver (SIL).
- Mercury free LEDs and 94% post consumer recyclability by weight.
- Mounting accessories sold separately.

| | DESCRIPTION | PRODUCT CODE | LIST PRICE | DIMENSIONS/INCHES | | |
|---|--|--------------|------------|-------------------|---|---|
| | | | | H | W | D |
|  | Revo LED Single Light Fixture | EVELEDRS | 763 | | | |
| | Revo LED Single Light Fixture w/Occupancy Sensor | EVELEDRSO | 1130 | | | |

ELECTRICAL

EVELEDRD - REVO LED DOUBLE LIGHT FIXTURE

- Double arm option with 9 ft. cord.
- Touch & hold dimming capability.
- Brightness adjustment from 100% to 15%.
- Available in Designer White (WHT), Black (BLK) or Silver (SIL).
- Mercury free LEDs and 94% post consumer recyclability by weight.
- Mounting accessories sold separately.

| | DESCRIPTION | PRODUCT CODE | LIST PRICE | DIMENSIONS/INCHES | | |
|---|--|--------------|------------|-------------------|---|---|
| | | | | H | W | D |
|  | Revo LED Double Light Fixture | EVELEDRD | 775 | | | |
| | Revo LED Double Light Fixture w/Occupancy Sensor | EVELEDRDO | 1146 | | | |

EVELEDAFS - FREESTANDING BASE

| | DESCRIPTION | PRODUCT CODE | LIST PRICE | DIMENSIONS/INCHES | | |
|---|-------------------|--------------|------------|-------------------|---|---|
| | | | | H | W | D |
|  | Freestanding Base | EVELEDAFS | 216 | | | |

EVELEDACM - CLAMP MOUNT

| | DESCRIPTION | PRODUCT CODE | LIST PRICE | DIMENSIONS/INCHES | | |
|---|-------------|--------------|------------|-------------------|---|---|
| | | | | H | W | D |
|  | Clamp Mount | EVELEDACM | 193 | | | |

EVELEDASW - SLATWALL MOUNT

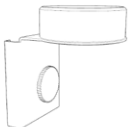
| | DESCRIPTION | PRODUCT CODE | LIST PRICE | DIMENSIONS/INCHES | | |
|---|----------------|--------------|------------|-------------------|---|---|
| | | | | H | W | D |
|  | Slatwall Mount | EVELEDASW | 193 | | | |



ELECTRICAL

EVELEDAPM - PANEL MOUNT

| | DESCRIPTION | PRODUCT CODE | LIST PRICE | DIMENSIONS/INCHES | | |
|---|-------------|--------------|------------|-------------------|---|---|
| | | | | H | W | D |
|  | Panel Mount | EVELEDAPM | 193 | | | |

EVELEDASM - SURFACE MOUNT

| | DESCRIPTION | PRODUCT CODE | LIST PRICE | DIMENSIONS/INCHES | | |
|---|---------------|--------------|------------|-------------------|---|---|
| | | | | H | W | D |
|  | Surface Mount | EVELEDASM | 193 | | | |

EVECC - CORD COVER

- Attaches to panels vertically between modules to provide enclosures for power or data cords.
- Available in 21" and 36" lengths, 6 per pack.
- Can be field cut to required length.

| | DESCRIPTION | PRODUCT CODE | LIST PRICE | DIMENSIONS/INCHES | | |
|---|-------------------------------------|--------------|------------|-------------------|---|---|
| | | | | H | W | D |
|  | Inline Cord Cover | EVECC121 | 35 | 21 | | |
| | For use at panel Inline connections | EVECC136 | 53 | 36 | | |
| | Corner Cord Cover | EVECC221 | 35 | 21 | | |
| | For use at panel Inline connections | EVECC236 | 53 | 36 | | |

EVH8RC - RACEWAY COVERS

- Raceway Cover with 1.38" x 2.71" duplex receptacle openings.
- Raceway Covers are sold individually.
- Includes up to three receptacle opening shields depending on width of raceway cover.

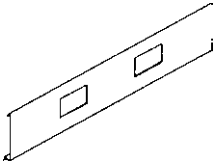
| | DESCRIPTION | PRODUCT CODE | LIST PRICE | DIMENSIONS/INCHES | | |
|---|----------------|--------------|------------|-------------------|----|---|
| | | | | H | W | D |
|  | Raceway Covers | EVH8RC18 | 25 | 6 | 18 | |
| | | EVH8RC24 | 36 | 6 | 24 | |
| | | EVH8RC30 | 49 | 6 | 30 | |
| | | EVH8RC36 | 55 | 6 | 36 | |
| | | EVH8RC42 | 61 | 6 | 42 | |
| | | EVH8RC48 | 66 | 6 | 48 | |
| | | EVH8RC54 | 77 | 6 | 54 | |
| | | EVH8RC60 | 85 | 6 | 60 | |

ELECTRICAL

EVEMAE - MINI-ADAPT POWER MODULE

- Attaches to scoop at the back of the worksurface.
- Includes two Simplex outlets.
- 6' black cord
- Available in black only.
- Note: Height (H) is measured above the worksurface.

| | DESCRIPTION | PRODUCT CODE | LIST PRICE | DIMENSIONS/INCHES | | |
|---|-------------------------|--------------|------------|-------------------|------|---|
| | | | | H | W | D |
|  | Mini-Adapt Power Module | EVEMAE1 | 233 | 2 | 3.58 | 3 |

EVEMAD - MINI-ADAPT POWER MODULE

- Attaches to scoop at the back of the worksurface.
- Includes two Voice/Data Port, Voice/Data Adapter Kit.
- Accepts Cat3, Cat 5, Cat 5e, Cat 6 jacks.
- Available in black only.
- Note: Height (H) is measured above the worksurface.

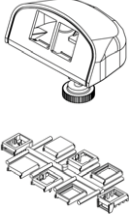
| | DESCRIPTION | PRODUCT CODE | LIST PRICE | DIMENSIONS/INCHES | | |
|--|-------------------------|--------------|------------|-------------------|------|---|
| | | | | H | W | D |
|  | Mini-Adapt Power Module | EVEMAD1 | 189 | 2 | 3.58 | 3 |

EVED50AC - CLAMP MOUNT 2 POWER/USB-A&C

- Ashley Duo clamp mount power module with two 15 amp 120 Volt AC receptacles
- 2.4 amp USB-A port and 60 watt USB-C power delivery port
- 10' power cord with molded plug
- UL listed: UL 962A.
- Clamp accommodates worksurfaces 0.5" to 1.5" thick
- Fastened with thumb screws.

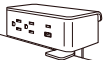
| | DESCRIPTION | PRODUCT CODE | LIST PRICE | DIMENSIONS/INCHES | | |
|---|------------------------------|--------------|------------|-------------------|-----|-----|
| | | | | H | W | D |
|  | White Module, Silver Bracket | EVED50ACW | 525 | 1.8 | 5.5 | 2.8 |
| | Black Module, Silver Bracket | EVED50ACB | 525 | 1.8 | 5.5 | 2.8 |

EVEDU51AC - UNDER MOUNT 2 POWER/USB-A&C

- Ashley Duo under mount power module with two 15 amp 120 Volt AC receptacles.
- 2.4 amp USB-A port and 60 watt USB-C power delivery port.
- 10' power cord with molded plug.
- UL listed: UL 962A.
- Mountable under most worksurfaces.
- Installation template provided.

| | DESCRIPTION | PRODUCT CODE | LIST PRICE | DIMENSIONS/INCHES | | |
|---|------------------------------|--------------|------------|-------------------|-----|-----|
| | | | | H | W | D |
|  | White Module, Silver Bracket | EVEDU51ACW | 525 | 3 | 5.5 | 3.2 |
| | Black Module, Silver Bracket | EVEDU51ACB | 525 | 3 | 5.5 | 3.2 |



worksurfaces

THE INFORMATION LISTED BELOW PROVIDES YOU WITH BASIC FEATURES OF EVOLVE WORKSURFACES.

- Evolve thermally fused worksurfaces are 1" thick, high pressure is 1 1/16" and 1 7/16" thick. These are finished with 3 mm PVC edging on all sides.
- Standard laminate offerings are available in thermally-fused (TF) and most high pressure laminates (HP). See laminate listings for details.
- Wood grain laminates on corner worksurfaces up to 42" available in laminate run diagonally for an upcharge. Otherwise, standard horizontal application of laminate will be used.
- To avoid unsatisfactory results in laminate application when attaching two corner surfaces side by side, select "WG" surfaces for matching grain.
- Some wood grain laminate worksurfaces will have matching wood grain PVC trim unless specified otherwise.
- The depth of the worksurface scoops are 1 1/8" when measured from the panel the worksurface is attached to.

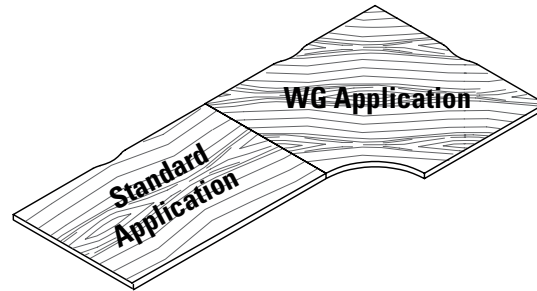

- All worksurfaces have threaded inserts for metal-to-metal connection for support hardware.
- All worksurfaces require support hardware. These are priced separately within this section.
- Communication and electrical wires are routed through a cable scoop located at the back of the worksurface. Depending on the specific surface, note that the number of cable scoops depends upon the width of the worksurface. All worksurface shapes have at least one scoop on the Panel edge.
- A 3/8" separation between the back of the worksurfaces and panels allows for cables to be moved to the panel seams and concealed by wire managers.
- Note: Wood veneer options for worksurfaces are available at an upcharge and with an extended lead time. Contact Evolve Customer Support for details.
- Tungsten (TUN) and Designer White (DWT) trim available at no charge.
- Note the following abbreviations:
TF = Thermally-Fused Laminate; (1") HP = High-Pressure Laminate (1 1/16"); HPW = High-Pressure Laminate (1 7/16"); WG = Wood Grain

One Scoop EVWS 24" - 48"

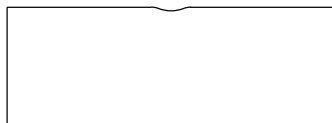

Two Scoops EVWS 54" - 72"

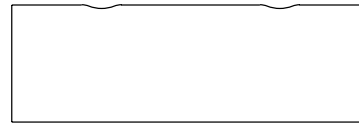

One Scoop EVWL 24" - 48"

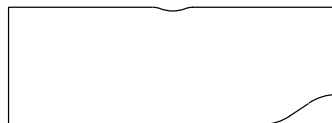

Two Scoops EVWL 54" - 72"



This page provides a three dimensional view of a sample configuration highlighting each **Worksurface** component required when specifying this configuration.

Components

- A. EVWVL2436 Curvilinear Worksurface – Left
Note: When deepest end equals 24", opposite depth is 18"
When deepest end equals 30", opposite depth is 24"
- B. EVWCC3618 Corner Curved Worksurface
- C. EVWR2436 Curvilinear Worksurface – Right
- D. EVWTEV1536 End Transaction Surface with Cut-out

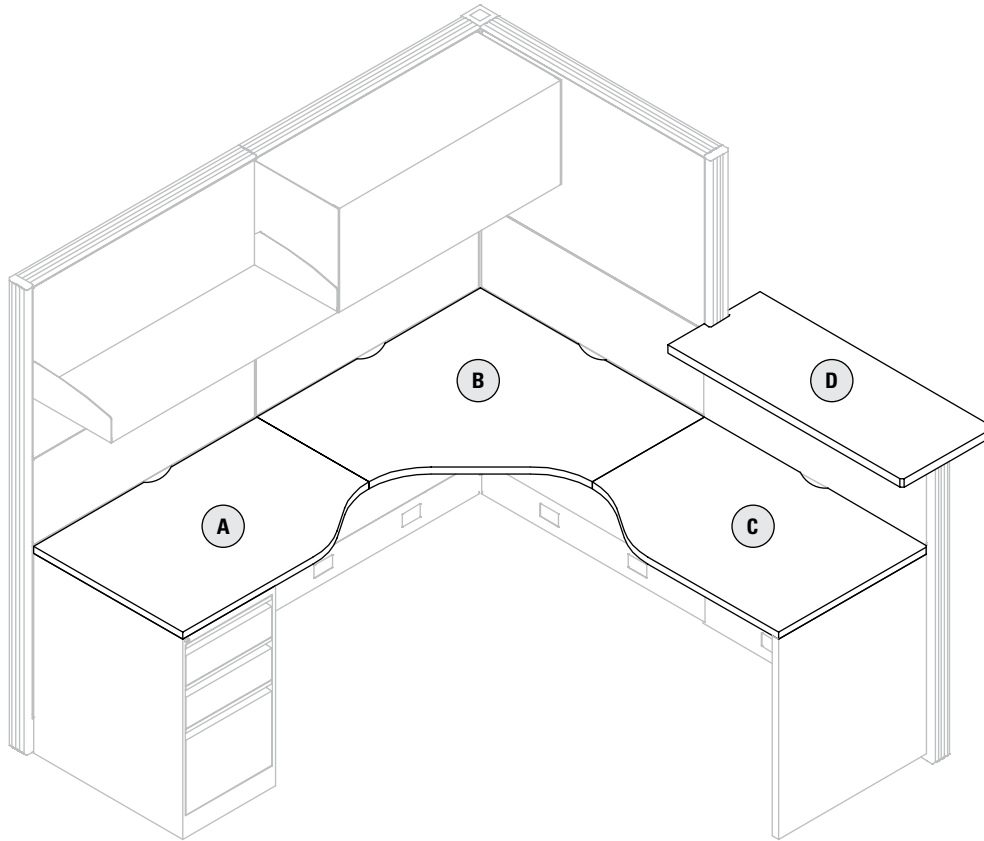

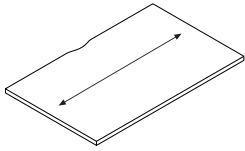

EVWS Worksurfaces

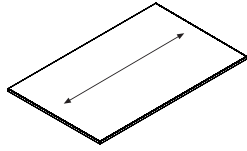

EVWSNS Worksurfaces

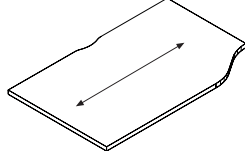

EVWVR Worksurfaces

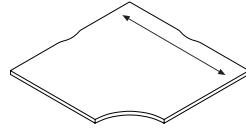

EVWCC Worksurfaces

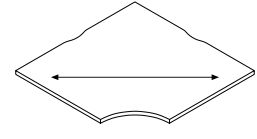

EVWCCxxxWG Worksurfaces

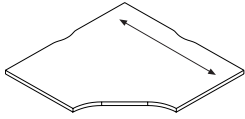

EVWCK Worksurfaces

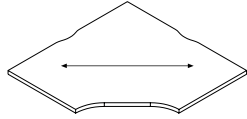

EVWCKxxxWG Worksurfaces

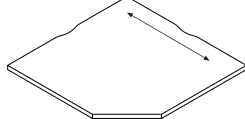

EVWCF Worksurfaces

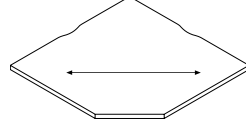

EVWCFxxxWG Worksurfaces

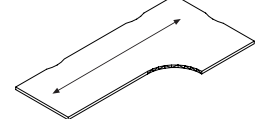

EVWCE Worksurfaces

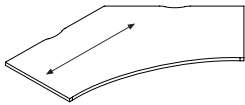

EVWC4C Worksurfaces

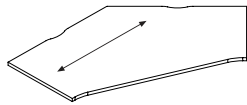

EVWC4K Worksurfaces

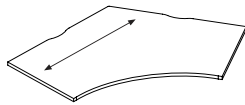

EVWC6C Worksurfaces

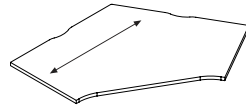

EVWC6K Worksurfaces

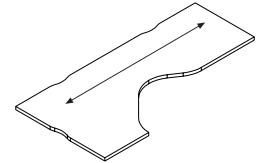

EVWL Worksurfaces

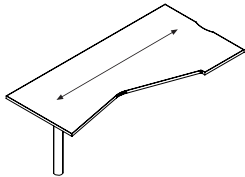

EVWHL Worksurfaces

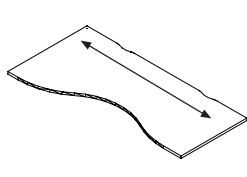

EVWBTL/R Worksurfaces

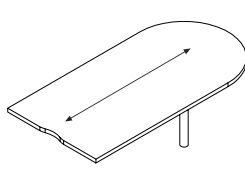

EVWD Worksurfaces

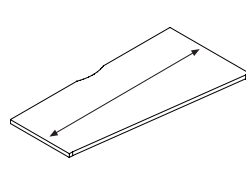

EVWSWL/R Worksurfaces

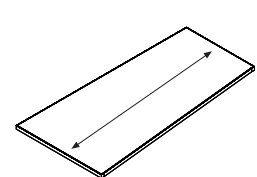

EVWSWNSL/R Worksurfaces

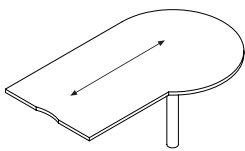

EVWP Worksurfaces

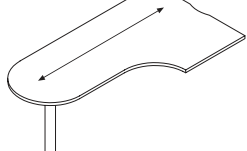

EVWPL/R Worksurfaces

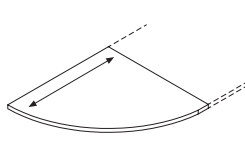

EVWQR and EVWQRC Worksurfaces

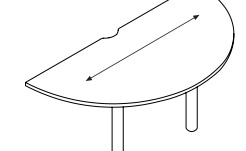

EVWR Worksurfaces

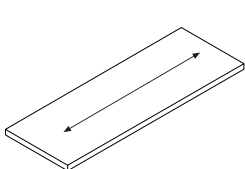

EVWT, EVWTV, EVWTW, EWTEV, EVWTD, EVWTDV, EVWTD D Worksurfaces

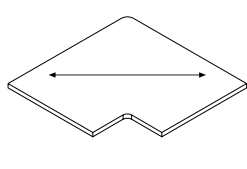

EVWTCLxxxWG Worksurfaces

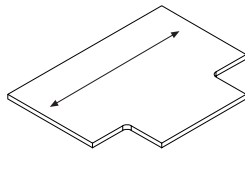

EVWTC Worksurfaces

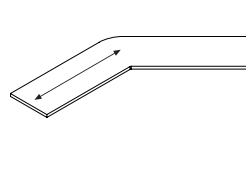

EVW4T Worksurface

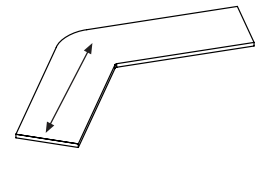

EVW6T Worksurfaces



EVWS - STRAIGHT WORKSURFACE

- Support hardware must be ordered separately. See listing in this section of the price book.
- Worksurfaces greater than 48" wide require additional structural support.
- Please choose from Designer White (DWT), Silver (SIL) or Black (BLK) for scoop covers.

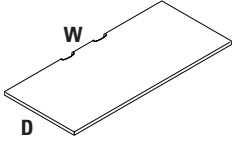
| DESCRIPTION | PRODUCT CODE | TF | PRICE | | DIMENSIONS/INCHES | |
|---|--------------|-----|--------|---------|-------------------|----|
| | | | HP ADD | HPW ADD | D | W |
|  Straight Worksurface - 18" Deep | EVWS1824P | 147 | 57 | 154 | 18 | 24 |
| | EVWS1830P | 154 | 59 | 168 | 18 | 30 |
| | EVWS1836P | 175 | 66 | 185 | 18 | 36 |
| | EVWS1842P | 227 | 91 | 249 | 18 | 42 |
| | EVWS1848P | 271 | 105 | 295 | 18 | 48 |
| | EVWS1854P | 319 | 128 | 350 | 18 | 54 |
| | EVWS1860P | 358 | 141 | 389 | 18 | 60 |
| | EVWS1866P | 374 | 147 | 403 | 18 | 66 |
| | EVWS1872P | 391 | 152 | 420 | 18 | 72 |
| | EVWS1878P | 554 | 288 | 703 | 18 | 78 |
| | EVWS1884P | 594 | 308 | 761 | 18 | 84 |
| | EVWS1890P | 636 | 329 | 811 | 18 | 90 |
| | EVWS1896P | 678 | 354 | 866 | 18 | 96 |
| Straight Worksurface - 24" Deep | EVWS2424P | 149 | 57 | 156 | 24 | 24 |
| | EVWS2430P | 159 | 61 | 168 | 24 | 30 |
| | EVWS2436P | 180 | 68 | 186 | 24 | 36 |
| | EVWS2442P | 229 | 91 | 250 | 24 | 42 |
| | EVWS2448P | 274 | 110 | 301 | 24 | 48 |
| | EVWS2454P | 323 | 127 | 350 | 24 | 54 |
| | EVWS2460P | 361 | 139 | 389 | 24 | 60 |
| | EVWS2466P | 378 | 148 | 405 | 24 | 66 |
| | EVWS2472P | 394 | 151 | 420 | 24 | 72 |
| | EVWS2478P | 633 | 181 | 587 | 24 | 78 |
| | EVWS2484P | 637 | 186 | 596 | 24 | 84 |
| | EVWS2490P | 636 | 329 | 811 | 24 | 90 |
| | EVWS2496P | 678 | 354 | 866 | 24 | 96 |
| Straight Worksurface - 30" Deep | EVWS3024P | 175 | 65 | 182 | 30 | 24 |
| | EVWS3030P | 185 | 75 | 205 | 30 | 30 |
| | EVWS3036P | 219 | 84 | 231 | 30 | 36 |
| | EVWS3042P | 306 | 117 | 327 | 30 | 42 |
| | EVWS3048P | 323 | 127 | 350 | 30 | 48 |
| | EVWS3054P | 355 | 135 | 378 | 30 | 54 |
| | EVWS3060P | 378 | 148 | 405 | 30 | 60 |
| | EVWS3066P | 393 | 152 | 421 | 30 | 66 |
| | EVWS3072P | 415 | 162 | 451 | 30 | 72 |
| | EVWS3078P | 786 | 231 | 737 | 30 | 78 |
| | EVWS3084P | 799 | 228 | 739 | 30 | 84 |
| | EVWS3090P | 795 | 415 | 1017 | 30 | 90 |
| | EVWS3096P | 847 | 440 | 1081 | 30 | 96 |

EVWSNSC - STRAIGHT WORKSURFACE NO SCOOP

- There is no scoop on this work surface.
- Support hardware must be ordered separately. See listing in this section of the price book.
- Surfaces not available in HPW.
- Worksurfaces greater than 48" wide require additional structural support.

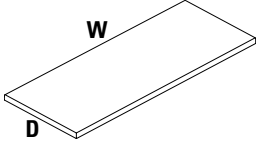
| | DESCRIPTION | PRODUCT CODE | PRICE | | DIMENSIONS/INCHES | |
|---|---|--------------|---|-------------|-------------------|----|
| | | | TF | HP ADD | D | W |
|  | Straight Worksurface No Scoops - 24" Deep | EVWSNSC2424 | 149 | 57 | 24 | 24 |
| | | EVWSNSC2430 | 159 | 217 | 24 | 30 |
| | | EVWSNSC2436 | 180 | 68 | 24 | 36 |
| | | EVWSNSC2442 | 229 | 91 | 24 | 42 |
| | | EVWSNSC2448 | 274 | 110 | 24 | 48 |
| | | EVWSNSC2454 | 323 | 127 | 24 | 54 |
| | | EVWSNSC2460 | 361 | 139 | 24 | 60 |
| | | EVWSNSC2466 | 378 | 148 | 24 | 66 |
| | | EVWSNSC2472 | 394 | 151 | 24 | 72 |
| | | EVWSNSC2478 | 633 | 181 | 24 | 78 |
| | | EVWSNSC2484 | 637 | 186 | 24 | 84 |
| | | EVWSNSC2490 | 636 | 329 | 24 | 90 |
| | | EVWSNSC2496 | 678 | 354 | 24 | 96 |
| | | | Straight Worksurface No Scoops - 30" Deep | EVWSNSC3024 | 175 | 65 |
| EVWSNSC3030 | 185 | | | 75 | 30 | 30 |
| EVWSNSC3036 | 219 | | | 84 | 30 | 30 |
| EVWSNSC3042 | 306 | | | 117 | 30 | 42 |
| EVWSNSC3048 | 323 | | | 127 | 30 | 48 |
| EVWSNSC3054 | 355 | | | 135 | 30 | 54 |
| EVWSNSC3060 | 378 | | | 148 | 30 | 60 |
| EVWSNSC3066 | 393 | | | 152 | 30 | 66 |
| EVWSNSC3072 | 415 | | | 162 | 30 | 72 |
| EVWSNSC3078 | 786 | | | 231 | 30 | 78 |
| EVWSNSC3084 | 799 | | | 228 | 30 | 84 |
| EVWSNSC3090 | 795 | | | 415 | 30 | 90 |
| EVWSNSC3096 | 847 | | | 440 | 30 | 96 |

EVWSWNSC - WEDGE WORKSURFACE NO SCOOP

- There is no scoop on this work surface.

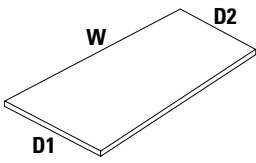
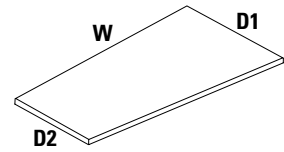
| | DIMENSIONS/INCHES | PRODUCT CODE | PRICE | | DIMENSIONS/INCHES | | |
|---|--|----------------|-------|--------|-------------------|----|----|
| | | | TF | HP ADD | D1 | D2 | W |
|  | Straight Wedge Worksurface No Scoops - Left | EVWSWNSC241848 | 385 | 112 | 24 | 18 | 48 |
| | | EVWSWNSC241854 | 434 | 556 | 24 | 18 | 54 |
| | | EVWSWNSC241860 | 479 | 142 | 24 | 18 | 60 |
| | | EVWSWNSC241866 | 531 | 152 | 24 | 18 | 66 |
| | | EVWSWNSC241872 | 575 | 170 | 24 | 18 | 72 |
| | | EVWSWNSC302448 | 479 | 142 | 30 | 24 | 48 |
| | | EVWSWNSC302454 | 539 | 695 | 30 | 24 | 54 |
| | | EVWSWNSC302460 | 600 | 770 | 30 | 24 | 60 |
| | | EVWSWNSC302466 | 658 | 847 | 30 | 24 | 66 |
| | | EVWSWNSC302472 | 719 | 923 | 30 | 24 | 72 |
|  | Straight Wedge Worksurface No Scoops - Right | EVWSWNSC182448 | 385 | 112 | 24 | 18 | 48 |
| | | EVWSWNSC182454 | 434 | 556 | 24 | 18 | 54 |
| | | EVWSWNSC182460 | 479 | 142 | 24 | 18 | 60 |
| | | EVWSWNSC182466 | 531 | 152 | 24 | 18 | 66 |
| | | EVWSWNSC182472 | 575 | 170 | 24 | 18 | 72 |
| | | EVWSWNSC243048 | 479 | 142 | 30 | 24 | 48 |
| | | EVWSWNSC243054 | 539 | 695 | 30 | 24 | 54 |
| | | EVWSWNSC243060 | 600 | 770 | 30 | 24 | 60 |
| | | EVWSWNSC243066 | 658 | 847 | 30 | 24 | 66 |
| | | EVWSWNSC243072 | 719 | 923 | 30 | 24 | 72 |



EWSP - STRAIGHT WORKSURFACE TO SPAN-A-POST

- Support hardware must be ordered separately. See listing in this section of the price book.
- Worksurfaces greater than 48" wide require additional structural support.
- Please choose from Designer White (DWT), Silver (SIL) or Black (BLK) for scoop covers.

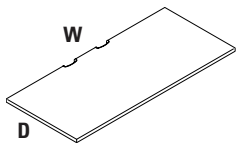
| | DESCRIPTION | PRODUCT CODE | PRICE | | | DIMENSIONS/INCHES | |
|---|--|--|-----------|--------|---------|-------------------|----|
| | | | TF | HP ADD | HPW ADD | D | W |
|  | Straight Worksurface to Span-a-Post - 18" Deep | EWWS1827P | 171 | 90 | 219 | 18 | 27 |
| | | EWWS1833P | 154 | 213 | 319 | 18 | 33 |
| | | EWWS1839P | 226 | 119 | 289 | 18 | 39 |
| | | EWWS1845P | 271 | 119 | 310 | 18 | 45 |
| | | EWWS1851P | 321 | 127 | 349 | 18 | 51 |
| | | EWWS1857P | 358 | 141 | 388 | 18 | 57 |
| | | EWWS1863P | 374 | 147 | 403 | 18 | 63 |
| | | EWWS1869P | 391 | 152 | 421 | 18 | 69 |
| | | EWWS1875P | 415 | 217 | 531 | 18 | 75 |
| | | EWWS1881P | 544 | 158 | 504 | 18 | 81 |
| | | EWWS1887P | 556 | 159 | 512 | 18 | 87 |
| | | Straight Worksurface to Span-a-Post - 24" Deep | EWWS2427P | 216 | 112 | 270 | 24 |
| | | EWWS2433P | 258 | 132 | 327 | 24 | 33 |
| | | EWWS2439P | 300 | 156 | 382 | 24 | 39 |
| | | EWWS2445P | 340 | 179 | 435 | 24 | 42 |
| | | EWWS2451P | 384 | 200 | 488 | 24 | 48 |
| | | EWWS2457P | 424 | 222 | 543 | 24 | 57 |
| | | EWWS2463P | 469 | 244 | 596 | 24 | 63 |
| | | EWWS2469P | 510 | 264 | 649 | 24 | 69 |
| | | EWWS2475P | 633 | 206 | 624 | 24 | 75 |
| | | EWWS2481P | 637 | 264 | 714 | 24 | 81 |
| | | EWWS2487P | 648 | 319 | 800 | 24 | 84 |
| | Straight Worksurface to Span-a-Post - 30" Deep | EWWS3027P | 267 | 141 | 341 | 30 | 27 |
| | | EWWS3033P | 321 | 167 | 405 | 30 | 33 |
| | | EWWS3039P | 371 | 196 | 477 | 30 | 39 |
| | | EWWS3045P | 424 | 222 | 543 | 30 | 45 |
| | | EWWS3051P | 479 | 249 | 609 | 30 | 48 |
| | | EWWS3057P | 532 | 277 | 678 | 30 | 57 |
| | | EWWS3063P | 583 | 303 | 745 | 30 | 63 |
| | | EWWS3069P | 636 | 329 | 811 | 30 | 69 |
| | | EWWS3075P | 786 | 261 | 781 | 30 | 75 |
| | | EWWS3081P | 799 | 270 | 805 | 30 | 81 |
| | | EWWS3087P | 839 | 369 | 972 | 30 | 87 |

EVWVL - CURVILINEAR WORKSURFACE - LEFT

- When deepest end equals 24", the opposite depth is 18". When deepest end equals 30", the opposite depth is 24".
- Support hardware must be ordered separately. See listing in this section of the price book.
- Worksurfaces greater than 48" wide require additional structural support.
- Please choose from Designer White (DWT), Silver (SIL) or Black (BLK) for scoop covers.

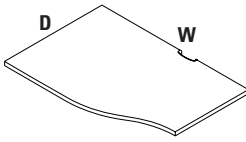
| DESCRIPTION | PRODUCT CODE | TF | PRICE | | DIMENSIONS/INCHES | |
|---|--------------|-----|--------|---------|-------------------|----|
| | | | HP ADD | HPW ADD | D | W |
|  Curvilinear Worksurface - 24" Deep | EVWVL2424P | 190 | 74 | 205 | 24 | 24 |
| | EVWVL2430P | 200 | 75 | 212 | 24 | 30 |
| | EVWVL2436P | 237 | 92 | 259 | 24 | 36 |
| | EVWVL2442P | 274 | 110 | 301 | 24 | 42 |
| | EVWVL2448P | 317 | 125 | 339 | 24 | 48 |
| | EVWVL2454P | 355 | 135 | 378 | 24 | 54 |
| | EVWVL2460P | 384 | 161 | 431 | 24 | 60 |
| | EVWVL2466P | 423 | 172 | 470 | 24 | 66 |
| | EVWVL2472P | 455 | 200 | 523 | 24 | 72 |
| | EVWVL2478P | 633 | 181 | 587 | 24 | 78 |
| | EVWVL2484P | 637 | 186 | 596 | 24 | 84 |
| Curvilinear Worksurface - 30" Deep | EVWVL3024P | 200 | 75 | 212 | 30 | 24 |
| | EVWVL3030P | 209 | 80 | 218 | 30 | 30 |
| | EVWVL3036P | 249 | 104 | 274 | 30 | 36 |
| | EVWVL3042P | 339 | 130 | 363 | 30 | 42 |
| | EVWVL3048P | 355 | 135 | 378 | 30 | 48 |
| | EVWVL3054P | 393 | 152 | 421 | 30 | 54 |
| | EVWVL3060P | 423 | 172 | 470 | 30 | 60 |
| | EVWVL3066P | 455 | 200 | 523 | 30 | 66 |
| | EVWVL3072P | 483 | 222 | 572 | 30 | 72 |
| | EVWVL3078P | 786 | 231 | 737 | 30 | 78 |
| | EVWVL3084P | 799 | 228 | 739 | 30 | 84 |

EVWVR - CURVILINEAR WORKSURFACE - RIGHT

- When deepest end equals 24", the opposite depth is 18". When deepest end equals 30", the opposite depth is 24".
- Support hardware must be ordered separately. See listing in this section of the price book.
- Please choose from Designer White (DWT), Silver (SIL) or Black (BLK) for scoop covers.

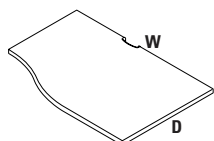
| DESCRIPTION | PRODUCT CODE | TF | PRICE | | DIMENSIONS/INCHES | |
|---|--------------|-----|--------|---------|-------------------|----|
| | | | HP ADD | HPW ADD | D | W |
|  Curvilinear Worksurface - 24" Deep | EVWVR2424P | 190 | 74 | 205 | 24 | 24 |
| | EVWVR2430P | 200 | 75 | 212 | 24 | 30 |
| | EVWVR2436P | 237 | 92 | 259 | 24 | 36 |
| | EVWVR2442P | 274 | 110 | 301 | 24 | 42 |
| | EVWVR2448P | 317 | 125 | 339 | 24 | 48 |
| | EVWVR2454P | 355 | 135 | 378 | 24 | 54 |
| | EVWVR2460P | 384 | 161 | 431 | 24 | 60 |
| | EVWVR2466P | 423 | 172 | 470 | 24 | 66 |
| | EVWVR2472P | 455 | 200 | 523 | 24 | 72 |
| | EVWVR2478P | 633 | 181 | 587 | 24 | 78 |
| | EVWVR2484P | 637 | 186 | 596 | 24 | 84 |
| Curvilinear Worksurface - 30" Deep | EVWVR3024P | 200 | 75 | 212 | 30 | 24 |
| | EVWVR3030P | 209 | 80 | 218 | 30 | 30 |
| | EVWVR3036P | 249 | 104 | 274 | 30 | 36 |
| | EVWVR3042P | 339 | 130 | 363 | 30 | 42 |
| | EVWVR3048P | 355 | 135 | 378 | 30 | 48 |
| | EVWVR3054P | 393 | 152 | 421 | 30 | 54 |
| | EVWVR3060P | 423 | 172 | 470 | 30 | 60 |
| | EVWVR3066P | 455 | 200 | 523 | 30 | 66 |
| | EVWVR3072P | 483 | 222 | 572 | 30 | 72 |
| | EVWVR3078P | 786 | 231 | 737 | 30 | 78 |
| | EVWVR3084P | 799 | 228 | 739 | 30 | 84 |



EVWCC - CORNER CURVED WORKSURFACE

- When specifying woodgrain laminate (WG) for corner worksurfaces 42" wide or less, choose from a diagonally run grain for an upcharge or standard application at no upcharge.
- Support hardware must be ordered separately. See listings in this section.
- Worksurfaces greater than 48" wide require additional structural support.
- Please choose from Designer White (DWT), Silver (SIL) or Black (BLK) for scoop covers.

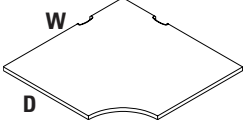
| | DESCRIPTION | PRODUCT CODE | PRICE | | | DIMENSIONS/INCHES | |
|---|---------------------------------|--------------|-------|--------|---------|-------------------|----|
| | | | TF | HP ADD | HPW ADD | D | W |
|  | Corner Curved Worksurface - 36" | EVWCC3618P | 499 | 161 | 490 | 18 | 36 |
| | | EVWCC3624P | 544 | 180 | 541 | 24 | 36 |
| | | EVWCC3618WGP | 556 | 181 | 546 | 18 | 36 |
| | | EVWCC3624WGP | 612 | 200 | 601 | 24 | 36 |
| | Corner Curved Worksurface - 42" | EVWCC4224P | 737 | 240 | 729 | 24 | 42 |
| | | EVWCC4230P | 801 | 259 | 784 | 30 | 42 |
| | | EVWCC4224WGP | 827 | 317 | 886 | 24 | 42 |
| | | EVWCC4230WGP | 899 | 289 | 878 | 30 | 42 |
| | Corner Curved Worksurface - 48" | EVWCC4824P | 862 | 260 | 816 | 24 | 48 |
| | | EVWCC4830P | 902 | 389 | 1032 | 30 | 48 |

EVWCC - CORNER ASYMMETRICAL WORKSURFACE

- When specifying woodgrain laminate (WG) for corner worksurfaces 42" wide or less, choose from a diagonally run grain for an upcharge or standard application at no upcharge.
- Support hardware must be ordered separately. See listings in this section.
- Please choose from Designer White (DWT), Silver (SIL) or Black (BLK) for scoop covers.

| | DESCRIPTION | PRODUCT CODE | PRICE | | | DIMENSIONS/INCHES | | |
|--|--|------------------|-------|--------|---------|-------------------|----|----|
| | | | TF | HP ADD | HPW ADD | D1 | D2 | W |
|  | Corner Worksurface - 36" x 36" x 18" x 24" | EVWCC36361824P | 554 | 129 | 471 | 18 | 24 | 36 |
| | | EVWCC36362418P | 554 | 679 | 1020 | 24 | 18 | 36 |
| | | EVWCC36361824WGP | 618 | 148 | 527 | 18 | 24 | 36 |
| | | EVWCC36362418WGP | 618 | 148 | 527 | 24 | 18 | 36 |
| | Corner Worksurface - 36" x 36" x 24" x 30" | EVWCC36362430P | 597 | 125 | 484 | 24 | 30 | 36 |
| | | EVWCC36363024P | 597 | 125 | 484 | 30 | 24 | 36 |
| | | EVWCC36362430WGP | 668 | 139 | 541 | 24 | 30 | 36 |
| | | EVWCC36363024WGP | 668 | 139 | 541 | 30 | 24 | 36 |
| | Corner Worksurface - 42" x 42" x 18" x 24" | EVWCC42421824P | 753 | 259 | 764 | 18 | 24 | 42 |
| | | EVWCC42422418P | 753 | 259 | 764 | 24 | 18 | 42 |
| | | EVWCC42421824WGP | 844 | 290 | 854 | 18 | 24 | 42 |
| | | EVWCC42422418WGP | 844 | 290 | 854 | 24 | 18 | 42 |
| | Corner Worksurface - 42" x 42" x 24" x 30" | EVWCC42422430P | 814 | 445 | 1074 | 24 | 30 | 42 |
| | | EVWCC42423024P | 814 | 445 | 1074 | 30 | 24 | 42 |
| | | EVWCC42422430WGP | 912 | 499 | 1198 | 24 | 30 | 42 |
| | | EVWCC42423024WGP | 912 | 499 | 1198 | 30 | 24 | 42 |
| | Corner Worksurface - 48" x 48" x 24" x 30" | EVWCC48482430P | 1042 | 392 | 1104 | 24 | 30 | 42 |
| | | EVWCC48483024P | 1042 | 392 | 1104 | 30 | 24 | 42 |

EVWCK - CORNER KEYBOARD WORKSURFACE

- When specifying woodgrain laminate (WG) for corner worksurfaces 42" wide or less, choose from a diagonally run grain for an upcharge or standard application at no upcharge.
- Support hardware must be ordered separately. See listings in this section.
- Worksurfaces greater than 48" wide require additional structural support.
- Please choose from Designer White (DWT), Silver (SIL) or Black (BLK) for scoop covers.

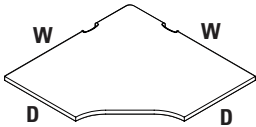
| | DESCRIPTION | PRODUCT CODE | PRICE | | | DIMENSIONS/INCHES | |
|---|-----------------------------------|--------------|-------|--------|---------|-------------------|----|
| | | | TF | HP ADD | HPW ADD | D | W |
|  | Corner Keyboard Worksurface - 36" | EWCK3618P | 505 | 162 | 495 | 18 | 36 |
| | | EWCK3624P | 649 | 182 | 596 | 24 | 36 |
| | | EWCK3618WGP | 567 | 182 | 555 | 18 | 36 |
| | | EWCK3624WGP | 730 | 203 | 666 | 24 | 36 |
| | Corner Keyboard Worksurface - 42" | EWCK4224P | 745 | 247 | 739 | 24 | 42 |
| | | EWCK4230P | 849 | 322 | 906 | 30 | 42 |
| | | EWCK4224WGP | 834 | 272 | 828 | 24 | 42 |
| | | EWCK4230WGP | 950 | 361 | 1012 | 30 | 42 |
| | Corner Keyboard Worksurface - 48" | EWCK4824P | 909 | 393 | 1043 | 24 | 48 |
| | | EWCK4830P | 1010 | 416 | 1129 | 30 | 48 |

EVWCF - FIVE-SIDED WORKSURFACE

- When specifying woodgrain laminate (WG) for corner worksurfaces 42" wide or less, choose from a diagonally run grain for an upcharge or standard application at no upcharge.
- Support hardware must be ordered separately. See listings in this section.
- Please choose from Designer White (DWT), Silver (SIL) or Black (BLK) for scoop covers.

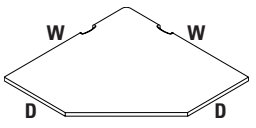
| | DESCRIPTION | PRODUCT CODE | PRICE | | | DIMENSIONS/INCHES | |
|--|---------------------------------------|--------------|-------|--------|---------|-------------------|----|
| | | | TF | HP ADD | HPW ADD | D | W |
|  | Five-Sided Keyboard Worksurface - 30" | EWCF3012P | 347 | 117 | 636 | 12 | 30 |
| | | EWCF3612P | 459 | 151 | 524 | 12 | 30 |
| | Five-Sided Keyboard Worksurface - 36" | EWCF3618P | 499 | 161 | 490 | 18 | 36 |
| | | EWCF3624P | 544 | 180 | 541 | 24 | 36 |
| | | EWCF3618WGP | 556 | 182 | 548 | 18 | 36 |
| | | EWCF3624WGP | 612 | 200 | 601 | 24 | 36 |
| | Five-Sided Keyboard Worksurface - 42" | EWCF4224P | 737 | 240 | 729 | 24 | 42 |
| | | EWCF4230P | 801 | 259 | 784 | 30 | 42 |
| | | EWCF4224WGP | 824 | 269 | 814 | 24 | 42 |
| | | EWCF4230WGP | 899 | 288 | 875 | 30 | 42 |
| | Five-Sided Keyboard Worksurface - 48" | EWCF4824P | 862 | 260 | 816 | 24 | 48 |
| | | EWCF4830P | 902 | 389 | 1032 | 30 | 48 |



EVWCCEL - EXTENDED CURVED CORNER - LEFT

- There are three cable scoops on this worksurface.
- Support hardware must be ordered separately. See listing in this section of the price book.
- Wood Grain Laminates do not run diagonally on Extended Curved Corners.
- Worksurfaces greater than 48" wide require additional structural support.
- Please choose from Designer White (DWT), Silver (SIL) or Black (BLK) for scoop covers.

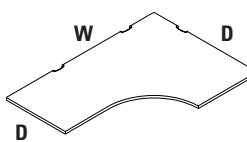
| | DESCRIPTION | PRODUCT CODE | PRICE | | | DIMENSIONS/INCHES | | |
|---|------------------------------------|----------------|-------|--------|---------|-------------------|----|----|
| | | | TF | HP ADD | HPW ADD | D1 | D2 | W |
|  | Extended Curved Corner - 36" x 24" | EVWCCEL362448P | 675 | 189 | 618 | 36 | 24 | 48 |
| | | EVWCCEL362460P | 735 | 209 | 679 | 36 | 24 | 60 |
| | | EVWCCEL362466P | 808 | 230 | 747 | 36 | 24 | 66 |
| | | EVWCCEL362472P | 891 | 259 | 830 | 36 | 24 | 72 |
| | | EVWCCEL362478P | 954 | 272 | 886 | 36 | 24 | 78 |
| | | EVWCCEL362484P | 1027 | 297 | 956 | 36 | 24 | 84 |
| | Extended Curved Corner - 42" x 24" | EVWCCEL422460P | 774 | 219 | 713 | 42 | 24 | 60 |
| | | EVWCCEL422466P | 849 | 247 | 791 | 42 | 24 | 66 |
| | | EVWCCEL422472P | 940 | 269 | 868 | 42 | 24 | 72 |
| | | EVWCCEL422478P | 1004 | 289 | 930 | 42 | 24 | 78 |
| | | EVWCCEL422484P | 1081 | 308 | 1006 | 42 | 24 | 84 |
| | Extended Curved Corner - 42" x 30" | EVWCCEL423060P | 869 | 252 | 811 | 42 | 30 | 60 |
| | | EVWCCEL423066P | 954 | 272 | 886 | 42 | 30 | 66 |
| | | EVWCCEL423072P | 1042 | 300 | 968 | 42 | 30 | 72 |
| | | EVWCCEL423078P | 1118 | 321 | 1037 | 42 | 30 | 78 |
| | | EVWCCEL423084P | 1191 | 341 | 1104 | 42 | 30 | 84 |
| | Extended Curved Corner - 48" x 24" | EVWCCEL482460P | 917 | 219 | 785 | 48 | 24 | 60 |
| | | EVWCCEL482466P | 988 | 272 | 905 | 48 | 24 | 66 |
| | | EVWCCEL482472P | 1062 | 318 | 1006 | 48 | 24 | 72 |
| | | EVWCCEL482478P | 1165 | 304 | 1040 | 48 | 24 | 78 |
| | | EVWCCEL482484P | 1215 | 348 | 1122 | 48 | 24 | 84 |
| | Extended Curved Corner - 48" x 30" | EVWCCEL483060P | 968 | 280 | 902 | 48 | 30 | 60 |
| | | EVWCCEL483066P | 1053 | 307 | 984 | 48 | 30 | 66 |
| | | EVWCCEL483072P | 1144 | 329 | 1063 | 48 | 30 | 72 |
| | | EVWCCEL483078P | 1229 | 356 | 1149 | 48 | 30 | 78 |
| | | EVWCCEL483084P | 1296 | 376 | 1210 | 48 | 30 | 84 |

EVWCER - EXTENDED CURVED CORNER - RIGHT

- There are three cable scoops on this worksurface.
- Support hardware must be ordered separately. See listing in this section of the price list.
- Wood Grain Laminates do not run diagonally on Extended Curved Corners.
- Worksurfaces greater than 48" wide require additional structural support.
- Please choose from Designer White (DWT), Silver (SIL) or Black (BLK) for scoop covers.

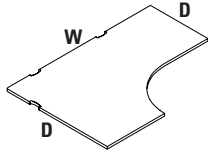
| DESCRIPTION | PRODUCT CODE | TF | PRICE | | DIMENSIONS/INCHES | | |
|--|------------------------------------|---------------|--------|---------|-------------------|----|----|
| | | | HP ADD | HPW ADD | D1 | D2 | W |
|  Extended Curved Corner - 36" x 24" | EVWCER362448P | 675 | 189 | 618 | 36 | 24 | 48 |
| | EVWCER362460P | 735 | 209 | 679 | 36 | 24 | 60 |
| | EVWCER362466P | 808 | 230 | 747 | 36 | 24 | 66 |
| | EVWCER362472P | 891 | 259 | 830 | 36 | 24 | 72 |
| | EVWCER362478P | 954 | 272 | 886 | 36 | 24 | 78 |
| | EVWCER362484P | 1027 | 297 | 956 | 36 | 24 | 84 |
| Extended Curved Corner - 42" x 24" | EVWCER422460P | 774 | 219 | 713 | 42 | 24 | 60 |
| | EVWCER422466P | 849 | 247 | 791 | 42 | 24 | 66 |
| | EVWCER422472P | 940 | 269 | 868 | 42 | 24 | 72 |
| | EVWCER422478P | 1004 | 289 | 930 | 42 | 24 | 78 |
| | EVWCER422484P | 1081 | 308 | 1006 | 42 | 24 | 84 |
| | Extended Curved Corner - 42" x 30" | EVWCER423060P | 869 | 252 | 811 | 42 | 30 |
| EVWCER423066P | | 954 | 272 | 886 | 42 | 30 | 66 |
| EVWCER423072P | | 1042 | 300 | 968 | 42 | 30 | 72 |
| EVWCER423078P | | 1118 | 321 | 1037 | 42 | 30 | 78 |
| EVWCER423084P | | 1191 | 341 | 1104 | 42 | 30 | 84 |
| Extended Curved Corner - 48" x 24" | | EVWCER482460P | 917 | 219 | 785 | 48 | 24 |
| | EVWCER482466P | 988 | 272 | 905 | 48 | 24 | 66 |
| | EVWCER482472P | 1062 | 318 | 1006 | 48 | 24 | 72 |
| | EVWCER482478P | 1165 | 304 | 1040 | 48 | 24 | 78 |
| | EVWCER482484P | 1215 | 348 | 1122 | 48 | 24 | 84 |
| | Extended Curved Corner - 48" x 30" | EVWCER483060P | 968 | 280 | 902 | 48 | 30 |
| EVWCER483066P | | 1053 | 307 | 984 | 48 | 30 | 66 |
| EVWCER483072P | | 1144 | 329 | 1063 | 48 | 30 | 72 |
| EVWCER483078P | | 1229 | 356 | 1149 | 48 | 30 | 78 |
| EVWCER483084P | | 1296 | 376 | 1210 | 48 | 30 | 84 |

EVWC4C - CURVED CORNER SURFACE FOR 45° POST

- Support hardware must be ordered separately. See the listing in this section.
- Please choose from Designer White (DWT), Silver (SIL) or Black (BLK) for scoop covers.

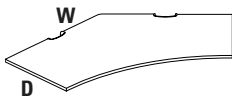
| DESCRIPTION | PRODUCT CODE | TF | PRICE | | DIMENSIONS/INCHES | |
|--|--|-------------|--------|---------|-------------------|----|
| | | | HP ADD | HPW ADD | D | W |
|  Corner Curved Surface for 45° Post - 18" | EVWC4C1824P | 476 | 139 | 444 | 18 | 24 |
| | EVWC4C1830P | 733 | 212 | 684 | 18 | 30 |
| | EVWC4C1836P | 1042 | 302 | 972 | 18 | 36 |
| | EVWC4C1842P | 1300 | 376 | 1212 | 18 | 42 |
| | EVWC4C1848P | 1516 | 438 | 1412 | 18 | 48 |
| | Corner Curved Surface for 45° Post - 24" | EVWC4C2424P | 571 | 167 | 533 | 24 |
| EVWC4C2430P | | 854 | 249 | 796 | 24 | 30 |
| EVWC4C2436P | | 1192 | 347 | 1111 | 24 | 36 |
| EVWC4C2442P | | 1300 | 376 | 1212 | 24 | 42 |
| EVWC4C2448P | | 1705 | 491 | 1589 | 24 | 48 |
| Corner Curved Surface for 45° Post - 30" | | EVWC4C3024P | 665 | 196 | 622 | 30 |
| | EVWC4C3030P | 1053 | 205 | 831 | 30 | 30 |
| | EVWC4C3036P | 1192 | 347 | 1111 | 30 | 36 |
| | EVWC4C3042P | 1460 | 423 | 1362 | 30 | 42 |
| | EVWC4C3048P | 1895 | 546 | 1764 | 30 | 48 |



EVWC4K - KEYBOARD CORNER SURFACE FOR 45° POST

- Support hardware must be ordered separately. See the listing in this section.
- Worksurfaces greater than 48" wide require additional structural support.
- Please choose from Designer White (DWT), Silver (SIL) or Black (BLK) for scoop covers.

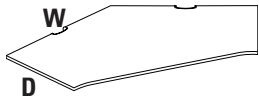
| | DESCRIPTION | PRODUCT CODE | PRICE | | | DIMENSIONS/INCHES | |
|---|--|--------------|-------|--------|---------|-------------------|----|
| | | | TF | HP ADD | HPW ADD | D | W |
|  | Keyboard Curved Surface for 45° Post - 18" | EVWC4K1824P | 476 | 139 | 444 | 18 | 24 |
| | | EVWC4K1830P | 733 | 212 | 684 | 18 | 30 |
| | | EVWC4K1836P | 1042 | 302 | 972 | 18 | 36 |
| | Keyboard Curved Surface for 45° Post - 24" | EVWC4K1842P | 1300 | 376 | 1212 | 18 | 42 |
| | | EVWC4K1848P | 1516 | 438 | 1412 | 18 | 48 |
| | | EVWC4K2424P | 571 | 167 | 533 | 24 | 24 |
| | | EVWC4K2430P | 854 | 249 | 796 | 24 | 30 |
| | | EVWC4K2436P | 1192 | 347 | 1111 | 24 | 36 |
| | | EVWC4K2442P | 1300 | 376 | 1212 | 24 | 42 |
| | Keyboard Curved Surface for 45° Post - 30" | EVWC4K2448P | 1705 | 491 | 1589 | 24 | 48 |
| | | EVWC4K3024P | 665 | 196 | 622 | 30 | 24 |
| | | EVWC4K3030P | 976 | 205 | 831 | 30 | 30 |
| EVWC4K3036P | | 1192 | 347 | 1111 | 30 | 36 | |
| EVWC4K3042P | | 1460 | 423 | 1362 | 30 | 42 | |
| EVWC4K3048P | | 1895 | 546 | 1764 | 30 | 48 | |

EVWC6C - CURVED CORNER SURFACE FOR 60° POST

- Support hardware must be ordered separately. See the listing in this section.
- Please choose from Designer White (DWT), Silver (SIL) or Black (BLK) for scoop covers.

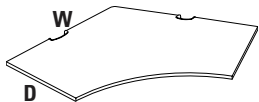
| | DESCRIPTION | PRODUCT CODE | LIST PRICE | | | DIMENSIONS/INCHES | |
|--|--|--------------|------------|--------|---------|-------------------|----|
| | | | TF | HP ADD | HPW ADD | ADD | W |
|  | Curved Curved Surface for 60° Post - 18" | EVWC6C1824P | 382 | 128 | 382 | 18 | 24 |
| | | EVWC6C1830P | 596 | 82 | 418 | 18 | 30 |
| | | EVWC6C1836P | 891 | 120 | 626 | 18 | 36 |
| | Curved Curved Surface for 60° Post - 24" | EVWC6C1842P | 1092 | 148 | 766 | 18 | 42 |
| | | EVWC6C1848P | 1487 | 201 | 1043 | 18 | 48 |
| | | EVWC6C2424P | 446 | 64 | 318 | 24 | 24 |
| | | EVWC6C2430P | 794 | 110 | 557 | 24 | 30 |
| | | EVWC6C2436P | 891 | 120 | 626 | 24 | 36 |
| | | EVWC6C2442P | 1363 | 182 | 952 | 24 | 42 |
| | Curved Curved Surface for 60° Post - 30" | EVWC6C2448P | 1487 | 201 | 1043 | 24 | 48 |
| | | EVWC6C3024P | 446 | 64 | 318 | 30 | 24 |
| | | EVWC6C3030P | 794 | 110 | 557 | 30 | 30 |
| EVWC6C3036P | | 891 | 120 | 626 | 30 | 36 | |
| EVWC6C3042P | | 1363 | 182 | 952 | 30 | 42 | |
| EVWC6C3048P | | 1487 | 201 | 1043 | 30 | 48 | |

EVWC6K - CURVED CORNER SURFACE FOR 60° POST

- Support hardware must be ordered separately. See the listing in this section.
- Please choose from Designer White (DWT), Silver (SIL) or Black (BLK) for scoop covers.

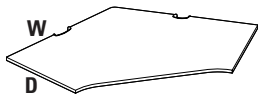
| | DESCRIPTION | PRODUCT CODE | PRICE | | | DIMENSIONS/INCHES | |
|---|--|--------------|-------|--------|---------|-------------------|----|
| | | | TF | HP ADD | HPW ADD | D | W |
|  | Keyboard Curved Surface for 60° Post - 18" | EVWC6K1824P | 373 | 135 | 389 | 18 | 24 |
| | | EVWC6K1830P | 596 | 82 | 418 | 18 | 30 |
| | | EVWC6K1836P | 891 | 120 | 626 | 18 | 36 |
| | Keyboard Curved Surface for 60° Post - 24" | EVWC6K1842P | 1092 | 148 | 766 | 18 | 42 |
| | | EVWC6K1848P | 1487 | 201 | 1043 | 18 | 48 |
| | | EVWC6K2430P | 794 | 110 | 557 | 24 | 30 |
| | | EVWC6K2436P | 891 | 120 | 626 | 24 | 36 |
| | | EVWC6K2442P | 1363 | 182 | 952 | 24 | 42 |
| | | EVWC6K2448P | 1487 | 201 | 1043 | 24 | 48 |
| | Keyboard Curved Surface for 60° Post - 30" | EVWC6K3030P | 794 | 110 | 557 | 30 | 30 |
| | | EVWC6K3036P | 889 | 297 | 887 | 30 | 36 |
| | | EVWC6K3042P | 1216 | 409 | 1217 | 30 | 42 |
| EVWC6K3048P | | 1473 | 504 | 1489 | 30 | 48 | |

WORKSURFACES

EVWL - "L" WORKSURFACE

- There are three cable scoops on this worksurface.
- Support hardware must be ordered separately. See listing in this section of the price list.
- Must be specified either left or right handed.
- Wood Grain Laminates do not run diagonally on Extended Curved Corners.
- Worksurfaces greater than 48" wide require additional structural support.
- Please choose from Designer White (DWT), Silver (SIL) or Black (BLK) for scoop covers.

| DESCRIPTION | PRODUCT CODE | TF | PRICE | | DIMENSIONS/INCHES | | |
|-----------------|--------------|-----|--------|---------|-------------------|----|--|
| | | | HP ADD | HPW ADD | D | W | |
| "L" Worksurface | EVWLL2472P | 765 | 289 | 809 | 24 | 72 | |
| | EVWLR2472P | 765 | 289 | 809 | 24 | 72 | |

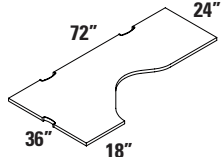

Right shown

EVWBT - 30" TRANSITION WORKSURFACE

- Support hardware must be ordered separately. See the listing in this section of the price list.
- Opposing side of 30" deep (D1) Transition Worksurface has depth of 24" (D2).
- Scoops located on back edge only.
- Must be specified as right or left handed.
- Please choose from Designer White (DWT), Silver (SIL) or Black (BLK) for scoop covers.

| DESCRIPTION | PRODUCT CODE | TF | PRICE | | DIMENSIONS/INCHES | | |
|--------------------------------------|--------------|-----|--------|---------|-------------------|----|----|
| | | | HP ADD | HPW ADD | D1 | D2 | W |
| Transition Worksurface - Left - 30" | EVWBTL3060P | 601 | 175 | 561 | 30 | 24 | 60 |
| | EVWBTL3066P | 664 | 190 | 615 | 30 | 24 | 66 |
| | EVWBTL3072P | 721 | 211 | 675 | 30 | 24 | 72 |
| Transition Worksurface - Right - 30" | EVWBTR3060P | 601 | 175 | 561 | 30 | 24 | 60 |
| | EVWBTR3066P | 664 | 190 | 615 | 30 | 24 | 66 |
| | EVWBTR3072P | 721 | 211 | 675 | 30 | 24 | 72 |

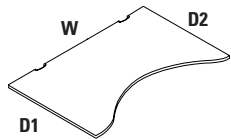

Left shown

EVWBT - 36" TRANSITION WORKSURFACE

- Support hardware must be ordered separately. See the listing in this section of the price list.
- Opposing side of 36" deep (D1) Transition Worksurface has depth of 30" (D2).
- Scoops located on back edge only.
- Must be specified as right or left handed.
- Please choose from Designer White (DWT), Silver (SIL) or Black (BLK) for scoop covers.

| DESCRIPTION | PRODUCT CODE | TF | PRICE | | DIMENSIONS/INCHES | | |
|--------------------------------------|--------------|-----|--------|---------|-------------------|----|----|
| | | | HP ADD | HPW ADD | D1 | D2 | W |
| Transition Worksurface - Left - 36" | EVWBTL3660P | 721 | 211 | 675 | 36 | 30 | 60 |
| | EVWBTL3666P | 794 | 230 | 741 | 36 | 30 | 66 |
| | EVWBTL3672P | 866 | 251 | 808 | 36 | 30 | 72 |
| Transition Worksurface - Right - 36" | EVWBTR3660P | 721 | 211 | 675 | 36 | 30 | 60 |
| | EVWBTR3666P | 794 | 230 | 741 | 36 | 30 | 66 |
| | EVWBTR3672P | 866 | 251 | 808 | 36 | 30 | 72 |

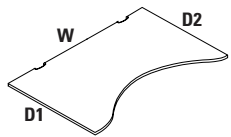

Left shown



WORKSURFACES

EVWSH - STRAIGHT EDGE HATCHET WORKSURFACE (LEFT SHOWN)

- Cable scoop is in the center of the 36" wide edge.
- Support hardware must be ordered separately. See listing in this section of the price list
- Monoleg is included
- Must be specified either left or right handed.
- Wood Grain Laminates do not run diagonally on Hatchet Corners
- Please choose from Designer White (DWT), Silver (SIL) or Black (BLK) for scoop covers.

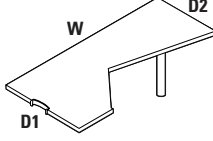
| | DESCRIPTION | PRODUCT CODE | PRICE | DIMENSIONS/INCHES | | |
|---|---|--------------|-------|-------------------|----|----|
| | | | | D1 | D2 | W |
|  | Straight Edge Hatchet Worksurface - Left | EVWSHL3672P | 1163 | 36 | 30 | 72 |
| | Straight Edge Hatchet Worksurface - Right | EVWSHR3672P | 1163 | 36 | 30 | 72 |

Left Shown

EVWD - "D" WORKSURFACE

- Support hardware must be ordered separately. See listing in this section of the price list.
- Monoleg is included
- Worksurfaces greater than 48" wide require additional structural support.
- Please choose from Designer White (DWT), Silver (SIL) or Black (BLK) for scoop covers.

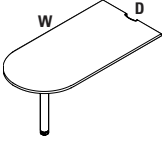
| | DESCRIPTION | PRODUCT CODE | TF | PRICE | | DIMENSIONS/INCHES | |
|---|-----------------------|--------------|-----|--------|---------|-------------------|----|
| | | | | HP ADD | HPW ADD | D | W |
|  | "D" Worksurface - 24" | EVWD2442P | 544 | 217 | 593 | 24 | 42 |
| | | EVWD2448P | 563 | 216 | 601 | 24 | 48 |
| | | EVWD2460P | 591 | 227 | 633 | 24 | 60 |
| | | EVWD2472P | 633 | 247 | 685 | 24 | 72 |
| | "D" Worksurface - 30" | EVWD3048P | 600 | 240 | 658 | 30 | 48 |
| | | EVWD3060P | 633 | 247 | 685 | 30 | 60 |
| | | EVWD3072P | 699 | 271 | 757 | 30 | 72 |

EVWPTR - "P" TOP

- There is one scoop on this worksurface.
- Support hardware must be ordered separately. See listing in this section of the price book.
- Must be specified either left or right handed.
- Monoleg is included.
- Please choose from Designer White (DWT), Silver (SIL) or Black (BLK) for scoop covers.

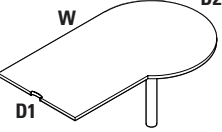
| | DESCRIPTION | PRODUCT CODE | TF | PRICE | | DIMENSIONS/INCHES | | |
|---|------------------------------------|---------------|------|--------|---------|-------------------|----|----|
| | | | | HP ADD | HPW ADD | D1 | D2 | W |
|  | "P" Top Worksurface - 24" Right | EVWPTR245430P | 834 | 244 | 780 | 24 | 30 | 54 |
| | | EVWPTR246030P | 896 | 240 | 807 | 24 | 30 | 60 |
| | | EVWPTR246630P | 938 | 259 | 854 | 24 | 30 | 66 |
| | | EVWPTR247230P | 987 | 267 | 889 | 24 | 30 | 72 |
| | "P" Top Worksurface - 30" Right | EVWPTR306036P | 987 | 259 | 879 | 30 | 36 | 60 |
| | | EVWPTR306636P | 1067 | 250 | 906 | 30 | 36 | 66 |
| | | EVWPTR307236P | 1141 | 240 | 927 | 30 | 36 | 72 |
| | "P" Top Worksurface - 24" Left | EVWPTL245430P | 834 | 244 | 780 | 24 | 30 | 54 |
| | | EVWPTL246030P | 896 | 240 | 807 | 24 | 30 | 60 |
| | | EVWPTL246630P | 938 | 259 | 854 | 24 | 30 | 66 |
| | | EVWPTL247230P | 987 | 267 | 889 | 24 | 30 | 72 |
| | "P" Top Worksurface - 30" Left | EVWPTL306036P | 987 | 259 | 879 | 30 | 36 | 60 |
| | | EVWPTL306636P | 1067 | 250 | 906 | 30 | 36 | 66 |
| | | EVWPTL307236P | 1141 | 240 | 927 | 30 | 36 | 72 |

Left Hand Shown

EVWSW - STRAIGHT WEDGE WORKSURFACES

- There is one scoop on this worksurface.
- Must be specified either left or right handed.
- Support hardware must be ordered separately. See listing in this section of the price book.
- Worksurfaces greater than 48" wide require additional structural support.
- Please choose from Designer White (DWT), Silver (SIL) or Black (BLK) for scoop covers.

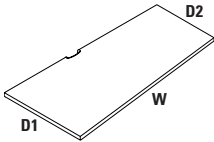
| | DESCRIPTION | PRODUCT CODE | PRICE | | | DIMENSIONS/INCHES | | | |
|---|-----------------------------------|------------------------------------|--------------|-----|-----|-------------------|----|----|----|
| | | | TF | HP | HPW | D1 | D2 | W | |
|  | Straight Wedge Worksurface - Left | EVWSW241848P | 385 | 112 | 356 | 24 | 18 | 48 | |
| | | EVWSW241854P | 434 | 126 | 403 | 24 | 18 | 54 | |
| | | EVWSW241860P | 479 | 142 | 451 | 24 | 18 | 60 | |
| | | EVWSW241866P | 531 | 152 | 492 | 24 | 18 | 66 | |
| | | EVWSW241872P | 575 | 170 | 541 | 24 | 18 | 72 | |
| | | | EVWSW302448P | 479 | 142 | 451 | 30 | 24 | 48 |
| | | | EVWSW302454P | 539 | 159 | 502 | 30 | 24 | 54 |
| | | | EVWSW302460P | 600 | 172 | 558 | 30 | 24 | 60 |
| | | | EVWSW302466P | 658 | 190 | 615 | 30 | 24 | 66 |
| | | | EVWSW302472P | 719 | 207 | 668 | 30 | 24 | 72 |
| | | Straight Wedge Worksurface - Right | EVWSW182448P | 385 | 112 | 356 | 18 | 24 | 48 |
| | | | EVWSW182454P | 434 | 126 | 403 | 18 | 24 | 54 |
| | | | EVWSW182460P | 479 | 142 | 451 | 18 | 24 | 60 |
| | | | EVWSW182466P | 531 | 152 | 492 | 18 | 24 | 66 |
| EVWSW182472P | | | 575 | 170 | 541 | 18 | 24 | 72 | |
| | | | EVWSW243048P | 479 | 142 | 451 | 24 | 30 | 48 |
| | | | EVWSW243054P | 539 | 159 | 502 | 24 | 30 | 54 |
| | | | EVWSW243060P | 600 | 172 | 558 | 24 | 30 | 60 |
| | | | EVWSW243066P | 658 | 190 | 615 | 24 | 30 | 66 |
| | | | EVWSW243072P | 719 | 207 | 668 | 24 | 30 | 72 |

EVWSWNSC - STRAIGHT WEDGE WORKSURFACES NO SCOOPS

- There is no scoop on this worksurface.
- Support hardware must be ordered separately. See listing in this section of the price book.
- Must be specified either left or right handed.
- Surfaces not available in HPW.

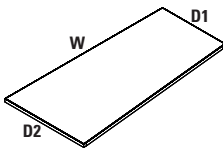
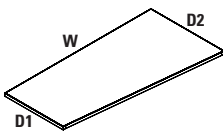
| | DESCRIPTION | PRODUCT CODE | PRICE | | DIMENSIONS/INCHES | | | |
|---|---|--|----------------|--------|-------------------|----|----|----|
| | | | TF | HP ADD | D1 | D2 | W | |
|  | Straight Wedge Worksurface No Scoops - Left | EVWSWNSC241848 | 385 | 112 | 24 | 18 | 48 | |
| | | EVWSWNSC241854 | 434 | 126 | 24 | 18 | 54 | |
| | | EVWSWNSC241860 | 479 | 142 | 24 | 18 | 60 | |
| | | EVWSWNSC241866 | 531 | 152 | 24 | 18 | 66 | |
| | | EVWSWNSC241872 | 575 | 170 | 24 | 18 | 72 | |
| | | | EVWSWNSC302448 | 479 | 142 | 30 | 24 | 48 |
| | | | EVWSWNSC302454 | 539 | 159 | 30 | 24 | 54 |
| | | | EVWSWNSC302460 | 600 | 172 | 30 | 24 | 60 |
| | | | EVWSWNSC302466 | 658 | 190 | 30 | 24 | 66 |
| | | | EVWSWNSC302472 | 719 | 207 | 30 | 24 | 72 |
| |  | Straight Wedge Worksurface No Scoops - Right | EVWSWNSC182448 | 385 | 112 | 18 | 24 | 48 |
| | | | EVWSWNSC182454 | 434 | 126 | 18 | 24 | 54 |
| | | | EVWSWNSC182460 | 479 | 142 | 18 | 24 | 60 |
| | | | EVWSWNSC182466 | 531 | 152 | 18 | 24 | 66 |
| EVWSWNSC182472 | | | 575 | 170 | 18 | 24 | 72 | |
| | | | EVWSWNSC243048 | 479 | 142 | 24 | 30 | 48 |
| | | | EVWSWNSC243054 | 539 | 159 | 24 | 30 | 54 |
| | | | EVWSWNSC243060 | 600 | 172 | 24 | 30 | 60 |
| | | | EVWSWNSC243066 | 658 | 190 | 24 | 30 | 66 |
| | | | EVWSWNSC243072 | 719 | 207 | 24 | 30 | 72 |



EVWPL - PIANO TOP - LEFT

- There is one scoop on this worksurface.
- Monoleg is included.
- Wood Grain Laminates do not run diagonally on Extended Curved Corners.
- Support hardware must be ordered separately. See listing in this section of the price book.
- Worksurfaces greater than 48" wide require additional structural support. Please choose from Designer White (DWT), Silver (SIL) or Black (BLK) for scoop covers.

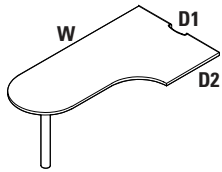

| DESCRIPTION | PRODUCT CODE | TF | PRICE | | DIMENSIONS/INCHES | | |
|------------------------------|--------------|------|--------|---------|-------------------|----|----|
| | | | HP ADD | HPW ADD | D1 | D2 | W |
| Piano Top - Left - 36" x 18" | EVWPL361848P | 757 | 244 | 739 | 36 | 18 | 48 |
| | EVWPL361854P | 829 | 230 | 757 | 36 | 18 | 54 |
| | EVWPL361860P | 891 | 228 | 785 | 36 | 18 | 60 |
| | EVWPL361866P | 961 | 219 | 808 | 36 | 18 | 66 |
| | EVWPL361872P | 1026 | 216 | 831 | 36 | 18 | 72 |
| Piano Top - Left - 36" x 24" | EVWPL362448P | 765 | 244 | 743 | 36 | 24 | 48 |
| | EVWPL362454P | 834 | 230 | 764 | 36 | 24 | 54 |
| | EVWPL362460P | 901 | 226 | 785 | 36 | 24 | 60 |
| | EVWPL362466P | 970 | 219 | 810 | 36 | 24 | 66 |
| | EVWPL362472P | 1032 | 216 | 835 | 36 | 24 | 72 |
| Piano Top - Left - 42" x 24" | EVWPL422454P | 1026 | 123 | 696 | 42 | 24 | 54 |
| | EVWPL422460P | 1088 | 127 | 733 | 42 | 24 | 60 |
| | EVWPL422466P | 1204 | 85 | 726 | 42 | 24 | 66 |
| Piano Top - Left - 42" x 30" | EVWPL422472P | 1278 | 74 | 747 | 42 | 24 | 72 |
| | EVWPL423060P | 1113 | 128 | 746 | 42 | 30 | 60 |
| | EVWPL423066P | 1230 | 84 | 736 | 42 | 30 | 66 |
| Piano Top - Left - 48" x 24" | EVWPL423072P | 1302 | 81 | 769 | 42 | 30 | 72 |
| | EVWPL482460P | 1152 | 240 | 935 | 48 | 24 | 60 |
| | EVWPL482466P | 1276 | 200 | 931 | 48 | 24 | 66 |
| Piano Top - Left - 48" x 30" | EVWPL482472P | 1352 | 207 | 984 | 48 | 24 | 72 |
| | EVWPL483066P | 1282 | 1477 | 2213 | 48 | 30 | 66 |
| | EVWPL483072P | 1358 | 207 | 986 | 48 | 30 | 72 |

EVWPR - PIANO TOP - RIGHT

- There is one scoop on this worksurface.
- Monoleg is included.
- Support hardware must be ordered separately. See listing in this section of the price book.
- Please choose from Designer White (DWT), Silver (SIL) or Black (BLK) for scoop covers.

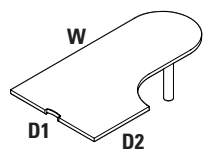

| DESCRIPTION | PRODUCT CODE | TF | PRICE | | DIMENSIONS/INCHES | | |
|-------------------------------|--------------|------|--------|---------|-------------------|----|----|
| | | | HP ADD | HPW ADD | D1 | D2 | W |
| Piano Top - Right - 36" x 18" | EVWPR361848P | 757 | 244 | 739 | 36 | 18 | 48 |
| | EVWPR361854P | 829 | 230 | 757 | 36 | 18 | 54 |
| | EVWPR361860P | 891 | 228 | 785 | 36 | 18 | 60 |
| | EVWPR361866P | 961 | 219 | 808 | 36 | 18 | 66 |
| | EVWPR361872P | 1026 | 216 | 831 | 36 | 18 | 72 |
| Piano Top - Right - 36" x 24" | EVWPR362448P | 765 | 244 | 743 | 36 | 24 | 48 |
| | EVWPR362454P | 834 | 230 | 764 | 36 | 24 | 54 |
| | EVWPR362460P | 901 | 226 | 785 | 36 | 24 | 60 |
| | EVWPR362466P | 970 | 219 | 810 | 36 | 24 | 66 |
| | EVWPR362472P | 1032 | 216 | 835 | 36 | 24 | 72 |
| Piano Top - Right - 42" x 24" | EVWPR422454P | 1026 | 123 | 696 | 42 | 24 | 54 |
| | EVWPR422460P | 1088 | 127 | 733 | 42 | 24 | 60 |
| | EVWPR422466P | 1204 | 85 | 726 | 42 | 24 | 66 |
| Piano Top - Right - 42" x 30" | EVWPR422472P | 1278 | 74 | 747 | 42 | 24 | 72 |
| | EVWPR423060P | 1113 | 128 | 746 | 42 | 30 | 60 |
| | EVWPR423066P | 1230 | 84 | 736 | 42 | 30 | 66 |
| Piano Top - Right - 48" x 24" | EVWPR423072P | 1302 | 81 | 769 | 42 | 30 | 72 |
| | EVWPR482460P | 1152 | 240 | 935 | 48 | 24 | 60 |
| | EVWPR482466P | 1276 | 200 | 931 | 48 | 24 | 66 |
| Piano Top - Right - 48" x 30" | EVWPR482472P | 1352 | 207 | 984 | 48 | 24 | 72 |
| | EVWPR483066P | 1282 | 198 | 932 | 48 | 30 | 66 |
| | EVWPR483072P | 1358 | 207 | 986 | 48 | 30 | 72 |

EVWQR - QUARTER ROUND PANEL WORKSURFACE

- The worksurface edge running along the panel is a slightly different length than that of the worksurface end, causing the surface to be handed.
- Left hand surface shown.
- The user edge abutting the adjacent worksurface runs straight for 3" before starting to curve.
- Support hardware must be ordered separately. See listing in this section of the price book.
- Worksurfaces greater than 48" wide require additional structural support.

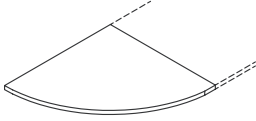
| | DESCRIPTION | PRODUCT CODE | PRICE | | | DIMENSIONS/INCHES | |
|---|---|--------------|-------|--------|---------|-------------------|----|
| | | | TF | HP ADD | HPW ADD | D | W |
|  | Quarter Round Panel Worksurface - Left | EWQRL1818 | 163 | 55 | 161 | 18 | 18 |
| | | EWQRL2424 | 229 | 80 | 230 | 24 | 24 |
| | | EWQRL3030 | 302 | 92 | 289 | 30 | 30 |
| | Quarter Round Panel Worksurface - Right | EWQRR1818 | 163 | 55 | 161 | 18 | 18 |
| | | EWQRR2424 | 229 | 80 | 230 | 24 | 24 |
| | | EWQRR3030 | 302 | 92 | 289 | 30 | 30 |

EVWQRC - QUARTER ROUND PANEL CORNER WORKSURFACE

- Wraps around a 90° corner post.
- The user edge abutting the adjacent worksurface runs straight for 3" before starting to curve.
- Support hardware must be ordered separately. See the listing in this section.

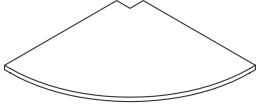
| | DESCRIPTION | PRODUCT CODE | PRICE | | | DIMENSIONS/INCHES | |
|---|--|--------------|-------|--------|---------|-------------------|----|
| | | | TF | HP ADD | HPW ADD | D | W |
|  | Quarter Round Panel Corner Worksurface | EVWQRC1818 | 190 | 64 | 187 | 18 | 18 |
| | | EVWQRC2424 | 272 | 88 | 269 | 24 | 24 |
| | | EVWQRC3030 | 338 | 112 | 330 | 30 | 30 |

EVWR - RADIUS WORKSURFACE

- Support hardware must be ordered separately. See listing in this section of the price book.
- Monoleg is included.
- Notched end is not finished.
- 18" and 24" come with one monoleg.
- 30" comes with two monolegs.
- Worksurfaces greater than 48" wide require additional structural support.
- Please choose from Designer White (DWT), Silver (SIL) or Black (BLK) for scoop covers.

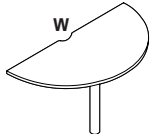
| | DESCRIPTION | PRODUCT CODE | LIST PRICE | | | DIMENSIONS/INCHES | |
|---|--------------------|--------------|------------|-----|------|-------------------|----|
| | | | TF | HP | HPW | D | W |
|  | Radius Worksurface | EVWR18 | 470 | 183 | 505 | 18 | 39 |
| | | EVWR24 | 543 | 213 | 591 | 24 | 51 |
| | | EVWR30 | 977 | 381 | 1053 | 30 | 63 |



EVWT - STRAIGHT TRANSACTION WORKSURFACE

- Support hardware must be ordered separately. See listing in this section of the price book.

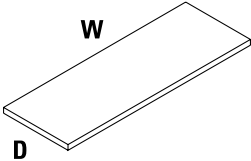
| | DESCRIPTION | PRODUCT CODE | TF | PRICE | | DIMENSIONS/INCHES | |
|---|----------------------------------|--------------|-----|--------|---------|-------------------|----|
| | | | | HP ADD | HPW ADD | D | W |
|  | Straight Transaction Worksurface | EVWT1512 | 66 | 29 | 74 | 15 | 12 |
| | | EVWT1518 | 87 | 33 | 90 | 15 | 18 |
| | | EVWT1524 | 104 | 43 | 115 | 15 | 24 |
| | | EVWT1530 | 125 | 48 | 130 | 15 | 30 |
| | | EVWT1536 | 141 | 57 | 152 | 15 | 36 |
| | | EVWT1542 | 160 | 64 | 171 | 15 | 42 |
| | | EVWT1548 | 181 | 68 | 187 | 15 | 48 |
| | | EVWT1554 | 197 | 76 | 213 | 15 | 54 |
| | | EVWT1560 | 218 | 84 | 230 | 15 | 60 |
| | | EVWT1566 | 233 | 92 | 258 | 15 | 66 |
| | | EVWT1572 | 252 | 99 | 270 | 15 | 72 |
| | | EVWT1578 | 271 | 104 | 290 | 15 | 78 |
| | | EVWT1584 | 290 | 115 | 314 | 15 | 84 |

EVWTV - STRAIGHT TRANSACTION WORKSURFACE WITH CUT-OUT

- Used when mounted to a panel that has a taller panel against it in a straight run at an inline.
- Support hardware must be ordered separately. See listing in this section of the price book.

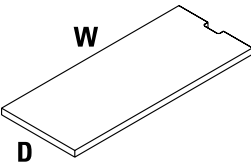
| | DESCRIPTION | PRODUCT CODE | TF | PRICE | | DIMENSIONS/INCHES | |
|--|---|--------------|-----|--------|---------|-------------------|----|
| | | | | HP ADD | HPW ADD | W | D |
|  | Straight Transaction Worksurface with Cut-Out | EVWTV1524 | 119 | 38 | 114 | 15 | 24 |
| | | EVWTV1530 | 131 | 53 | 139 | 15 | 30 |
| | | EVWTV1536 | 152 | 55 | 156 | 15 | 36 |
| | | EVWTV1542 | 171 | 64 | 180 | 15 | 42 |
| | | EVWTV1548 | 190 | 70 | 201 | 15 | 48 |
| | | EVWTV1554 | 209 | 75 | 216 | 15 | 54 |
| | | EVWTV1560 | 227 | 76 | 227 | 15 | 60 |
| | | EVWTV1566 | 249 | 354 | 527 | 15 | 66 |
| | | EVWTV1572 | 262 | 101 | 281 | 15 | 72 |

EVWTCL - "L" CORNER TRANSACTION SURFACE

- When specifying this item along with a straight surface, deduct 12" from each return side.
- Support hardware must be ordered separately. See listing in this section of the price book.
- Worksurfaces greater than 48" wide require additional structural support.

| DESCRIPTION | PRODUCT CODE | TF | PRICE | | DIMENSIONS/INCHES | |
|-------------|--------------|----|--------|---------|-------------------|---|
| | | | HP ADD | HPW ADD | D | W |

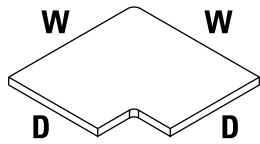

| | | | | | | |
|--------------------------------|----------|-----|----|-----|----|----|
| "L" Corner Transaction Surface | EVWTCL90 | 192 | 65 | 190 | 15 | 21 |
|--------------------------------|----------|-----|----|-----|----|----|

EVWTCT - "T" CORNER TRANSACTION SURFACE

- When specifying this item along with a straight surface, deduct 12" from each return side
- Support hardware must be ordered separately. See listing in this section of the price book.

| DESCRIPTION | PRODUCT CODE | TF | PRICE | | DIMENSIONS/INCHES | |
|-------------|--------------|----|--------|---------|-------------------|---|
| | | | HP ADD | HPW ADD | D | W |

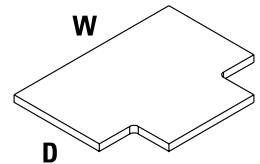

| | | | | | | |
|--------------------------------|----------|-----|----|-----|----|----|
| "T" Corner Transaction Surface | EVWTCT90 | 170 | 65 | 181 | 15 | 27 |
|--------------------------------|----------|-----|----|-----|----|----|

EVWTE - END TRANSACTION SURFACE

- Extends 1" past end of run.
- Support hardware must be ordered separately. See listing in this section of the price book.

| DESCRIPTION | PRODUCT CODE | TF | PRICE | | DIMENSIONS/INCHES | |
|-------------|--------------|----|--------|---------|-------------------|---|
| | | | HP ADD | HPW ADD | D | W |

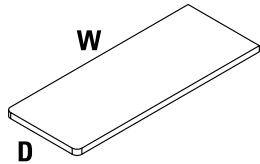

| | | | | | | |
|-------------------------|-----------|-----|-----|-----|----|----|
| End Transaction Surface | EWWTE1512 | 87 | 33 | 90 | 15 | 14 |
| | EWWTE1518 | 104 | 43 | 115 | 15 | 20 |
| | EWWTE1524 | 125 | 48 | 130 | 15 | 26 |
| | EWWTE1530 | 141 | 57 | 152 | 15 | 32 |
| | EWWTE1536 | 160 | 64 | 171 | 15 | 38 |
| | EWWTE1542 | 181 | 68 | 187 | 15 | 44 |
| | EWWTE1548 | 197 | 76 | 213 | 15 | 50 |
| | EWWTE1554 | 218 | 84 | 230 | 15 | 56 |
| | EWWTE1560 | 233 | 92 | 258 | 15 | 62 |
| | EWWTE1566 | 252 | 99 | 270 | 15 | 68 |
| | EWWTE1572 | 271 | 104 | 290 | 15 | 74 |

EVWTEV - END TRANSACTION SURFACE WITH CUT-OUT

- Used when mounted to a panel that has a taller panel against it in a straight run at an inline.
- Support hardware must be ordered separately. See listing in this section of the price book.
- Notched end is not finished.
- Extends 1" past end of run

| DESCRIPTION | PRODUCT CODE | TF | PRICE | | DIMENSIONS/INCHES | |
|-------------|--------------|----|--------|---------|-------------------|---|
| | | | HP ADD | HPW ADD | D | W |

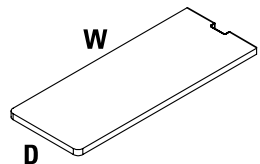

| | | | | | | |
|--------------------------------------|------------|-----|-----|-----|----|----|
| End Transaction Surface with Cut-Out | EVWTEV1524 | 131 | 53 | 139 | 15 | 26 |
| | EVWTEV1530 | 152 | 55 | 156 | 15 | 32 |
| | EVWTEV1536 | 171 | 64 | 180 | 15 | 38 |
| | EVWTEV1542 | 190 | 70 | 201 | 15 | 44 |
| | EVWTEV1548 | 209 | 75 | 216 | 15 | 50 |
| | EVWTEV1554 | 227 | 87 | 240 | 15 | 56 |
| | EVWTEV1560 | 249 | 88 | 258 | 15 | 62 |
| | EVWTEV1566 | 262 | 102 | 282 | 15 | 68 |
| | EVWTEV1572 | 282 | 109 | 300 | 15 | 74 |



EVWTD - "D" TRANSACTION SURFACE

- Support hardware must be ordered separately. See listing in this section of the price book.
- Worksurfaces greater than 48" wide require additional structural support.

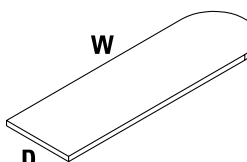
| DESCRIPTION | PRODUCT CODE | TF | PRICE | | DIMENSIONS/INCHES | |
|--|--------------|-----|--------|---------|-------------------|----|
| | | | HP ADD | HPW ADD | D | W |
|  <p>"D" Transaction Surface</p> | EVWTD1530 | 159 | 61 | 168 | 15 | 37 |
| | EVWTD1536 | 170 | 66 | 182 | 15 | 43 |
| | EVWTD1542 | 187 | 74 | 203 | 15 | 49 |
| | EVWTD1548 | 209 | 80 | 218 | 15 | 55 |
| | EVWTD1554 | 226 | 90 | 247 | 15 | 61 |
| | EVWTD1560 | 249 | 94 | 262 | 15 | 67 |
| | EVWTD1566 | 263 | 105 | 290 | 15 | 73 |
| | EVWTD1572 | 289 | 115 | 314 | 15 | 79 |

EVWTDV - END "D" TRANSACTION SURFACE WITH CUT-OUT

- Notched end is not finished.
- Used when mounted to a panel that has a taller panel against it in a straight run at an inline.
- Support hardware must be ordered separately. See listing in this section of the price book.

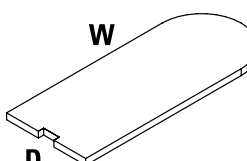
| DESCRIPTION | PRODUCT CODE | TF | PRICE | | DIMENSIONS/INCHES | |
|---|--------------|-----|--------|---------|-------------------|----|
| | | | HP ADD | HPW ADD | D | W |
|  <p>End "D" Transaction Surface with Cut-Out</p> | EVWTDV1530 | 170 | 59 | 172 | 15 | 37 |
| | EVWTDV1536 | 181 | 66 | 185 | 15 | 43 |
| | EVWTDV1542 | 200 | 73 | 206 | 15 | 49 |
| | EVWTDV1548 | 219 | 81 | 228 | 15 | 55 |
| | EVWTDV1554 | 233 | 88 | 248 | 15 | 61 |
| | EVWTDV1560 | 258 | 97 | 270 | 15 | 67 |

EVWTD - DOUBLE "D" TRANSACTION SURFACE

- Support hardware must be ordered separately. See listing in this section of the price book.

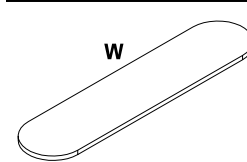
| DESCRIPTION | PRODUCT CODE | TF | PRICE | | DIMENSIONS/INCHES | |
|---|--------------|-----|--------|---------|-------------------|----|
| | | | HP ADD | HPW ADD | D | W |
|  <p>Double "D" Transaction Surface</p> | EVWTD1548 | 233 | 92 | 258 | 15 | 48 |
| | EVWTD1560 | 271 | 104 | 290 | 15 | 60 |
| | EVWTD1572 | 317 | 125 | 339 | 15 | 72 |

EVW4T - CORNER TRANSACTION SURFACE FOR 45° POST

- Support hardware must be ordered separately. See listing in this section of the price book.

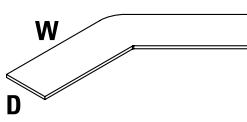
| DESCRIPTION | PRODUCT CODE | TF | PRICE | | DIMENSIONS/INCHES | |
|--|--------------|------|--------|---------|-------------------|----|
| | | | HP ADD | HPW ADD | W | D |
|  <p>Corner Transaction Surface for 45° Post</p> | EVW4T1524 | 652 | 187 | 607 | 15 | 24 |
| | EVW4T1530 | 813 | 237 | 761 | 15 | 30 |
| | EVW4T1536 | 1138 | 329 | 1060 | 15 | 36 |
| | EVW4T1542 | 1516 | 438 | 1412 | 15 | 42 |
| | EVW4T1548 | 1625 | 469 | 1514 | 15 | 48 |

EVW6T - CORNER TRANSACTION SURFACE FOR 60° POST

- Support hardware must be ordered separately. See listing in this section of the price book.
- Worksurfaces greater than 48" wide require additional structural support.

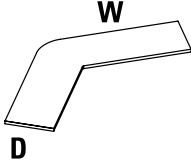
| DESCRIPTION | PRODUCT CODE | TF | PRICE | | DIMENSIONS/INCHES | |
|---|---|------|--------|---------|-------------------|----|
| | | | HP ADD | HPW ADD | D | W |
|  | Corner Transaction Surface for 60° Post | 382 | 126 | 374 | 15 | 18 |
| | EWV6T1518 | 597 | 202 | 596 | 15 | 24 |
| | EWV6T1530 | 777 | 261 | 777 | 15 | 30 |
| | EWV6T1536 | 1080 | 362 | 1081 | 15 | 36 |
| | EWV6T1542 | 1176 | 395 | 1179 | 15 | 42 |
| | EWV6T1548 | 1538 | 515 | 1542 | 15 | 48 |

EVW9T - CORNER TRANSACTION SURFACE FOR 90° POST

- Support hardware must be ordered separately. See listing in this section of the price book.

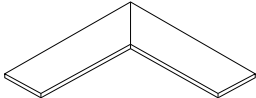
| DESCRIPTION | PRODUCT CODE | TF | PRICE | | DIMENSIONS/INCHES | |
|---|---|-----|--------|---------|-------------------|----|
| | | | HP ADD | HPW ADD | D | W |
|  | Corner Transaction Surface for 90° Post - Left | 371 | 196 | 477 | 15 | 24 |
| | EWV9TL1524 | 445 | 239 | 577 | 15 | 30 |
| | EWV9TL1536 | 520 | 270 | 665 | 15 | 36 |
| | EWV9TL1542 | 594 | 308 | 761 | 15 | 42 |
| | EWV9TL1548 | 668 | 349 | 854 | 15 | 48 |
| | Corner Transaction Surface for 90° Post - Right | 371 | 196 | 477 | 15 | 24 |
| | EWV9TR1524 | 445 | 239 | 577 | 15 | 30 |
| | EWV9TR1536 | 520 | 270 | 665 | 15 | 36 |
| | EWV9TR1542 | 594 | 308 | 761 | 15 | 42 |
| | EWV9TR1548 | 668 | 349 | 854 | 15 | 48 |

EVWMP - WORKSURFACE MODESTY PANEL

- Modesty panel fastens to the worksurface and monoleg to provide additional privacy and support
- Made of cold rolled steel
- Metal finish is durable epoxy powder coated.

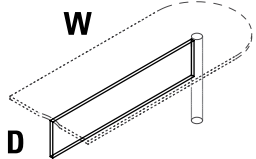
| DESCRIPTION | PRODUCT CODE | LIST PRICE | DIMENSIONS/INCHES | |
|---|---------------------------|------------|-------------------|----|
| | | | D | W |
|  | Worksurface Modesty Panel | 127 | 12 | 26 |
| | EWVMP1242 | 127 | 12 | 32 |
| | EWVMP1248 | 151 | 12 | 44 |
| | EWVMP1260 | 170 | 12 | 56 |

EVHEP - END PANEL

- Supports the worksurface and enhances the stability of connected panels.
- Provides solid support at the end of a run of worksurfaces.
- Finished in thermally-fused laminate.
- Includes flat brackets and hardware.
- End panel height is inclusive of panel glides extended to their fullest height.
- If wood grains is selected, grain runs vertically.

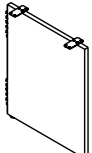
| DESCRIPTION | PRODUCT CODE | LIST PRICE | DIMENSIONS/INCHES | |
|---|----------------------|------------|-------------------|----|
| | | | D | H |
|  | End Panel - 29" High | 190 | 18 | 28 |
| | EVHEP2918 | 280 | 24 | 28 |
| | EVHEP2924 | 327 | 30 | 28 |



EVWS - STRAIGHT WORKSURFACE - HEIGHT ADJUSTABLE

- Support hardware must be ordered separately. See listing in this section of the price book.
- There is no scoop in this worksurface.

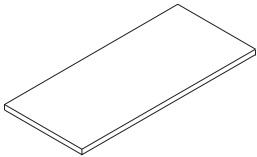
| DESCRIPTION | PRODUCT CODE | PRICE | | | DIMENSIONS/INCHES | | |
|---|----------------------|----------|--------|---------|-------------------|----|----|
| | | LP | HP ADD | HPW ADD | D | W | |
|  | Straight Worksurface | EVWS2346 | 274 | 59 | 167 | 23 | 46 |
| | | EVWS2352 | 323 | 127 | 350 | 23 | 52 |
| | | EVWS2358 | 361 | 139 | 388 | 23 | 58 |
| | | EVWS2364 | 378 | 148 | 404 | 23 | 64 |
| | | EVWS2370 | 394 | 150 | 420 | 23 | 70 |
| | | EVWS2376 | 633 | 181 | 583 | 23 | 76 |
| | | EVWS2382 | 637 | 187 | 596 | 23 | 82 |
| | | EVWS2946 | 323 | 127 | 350 | 29 | 46 |
| | | EVWS2952 | 355 | 135 | 378 | 29 | 52 |
| | | EVWS2958 | 378 | 148 | 404 | 29 | 58 |
| | | EVWS2964 | 393 | 151 | 421 | 29 | 64 |
| | | EVWS2970 | 415 | 162 | 451 | 29 | 70 |
| | | EVWS2976 | 786 | 231 | 737 | 29 | 76 |
| | | EVWS2982 | 799 | 227 | 739 | 29 | 82 |

EVWS - STRAIGHT WORKSURFACE - HEIGHT ADJUSTABLE RETURNS

- Support hardware must be ordered separately. See listing in this section of the price book.
- There is no scoop in this worksurface.

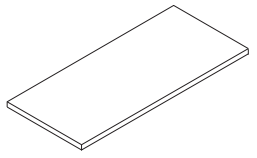
| DESCRIPTION | PRODUCT CODE | PRICE | | | DIMENSIONS/INCHES | | |
|--|----------------------|----------|--------|---------|-------------------|----|----|
| | | LP | HP ADD | HPW ADD | D | W | |
|  | Straight Worksurface | EVWS2329 | 159 | 59 | 167 | 23 | 29 |
| | | EVWS2335 | 180 | 68 | 186 | 23 | 35 |
| | | EVWS2341 | 229 | 91 | 250 | 23 | 41 |
| | | EVWS2347 | 274 | 110 | 301 | 23 | 47 |
| | | EVWS2353 | 323 | 127 | 350 | 23 | 53 |
| | | EVWS2359 | 361 | 139 | 388 | 23 | 59 |
| | | EVWS2929 | 185 | 76 | 205 | 29 | 29 |
| | | EVWS2935 | 219 | 84 | 231 | 29 | 35 |
| | | EVWS2941 | 306 | 116 | 327 | 29 | 41 |
| | | EVWS2947 | 323 | 127 | 350 | 29 | 47 |
| | | EVWS2953 | 355 | 135 | 378 | 29 | 53 |
| | | EVWS2959 | 378 | 148 | 404 | 29 | 59 |

EVWCC - CORNER SURVED WORKSURFACE - HEIGHT ADJUSTABLE

- Support hardware must be ordered separately. See listing in this section of the price book.
- There is no scoop in this worksurface.

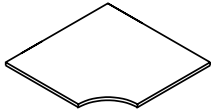
| DESCRIPTION | PRODUCT CODE | PRICE | | | DIMENSIONS/INCHES | | |
|---|---------------------------|-----------|--------|---------|-------------------|----|----|
| | | LP | HP ADD | HPW ADD | D | W | |
|  | Corner Curved Worksurface | EVWCC5223 | 978 | 429 | 982 | 23 | 52 |
| | | EVWCC5823 | 1302 | 528 | 1039 | 23 | 58 |
| | | EVWCC4629 | 902 | 388 | 1029 | 29 | 46 |
| | | EVWCC5229 | 978 | 429 | 982 | 29 | 52 |
| | | EVWCC5829 | 1302 | 528 | 1039 | 29 | 58 |

EVWCCEL - EXTENDED CORNER WORKSURFACE - HEIGHT ADJUSTABLE

- Support hardware must be ordered separately. See listing in this section of the price book.
- There is no scoop in this worksurface.

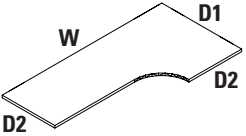
| DESCRIPTION | PRODUCT CODE | LP | PRICE | | DIMENSIONS/INCHES | | |
|--|---------------|------|--------|---------|-------------------|----|----|
| | | | HP ADD | HPW ADD | D1 | D2 | W |
|  <p>Extended Corner Worksurface</p> | EWWCCEL462358 | 917 | 218 | 785 | 46 | 23 | 58 |
| | EWWCCEL462364 | 988 | 272 | 906 | 46 | 23 | 64 |
| | EWWCCEL462370 | 1062 | 317 | 1004 | 46 | 23 | 70 |
| | EWWCCEL462376 | 1165 | 306 | 1039 | 46 | 23 | 76 |
| | EWWCCEL462382 | 1215 | 348 | 1122 | 46 | 23 | 82 |
| | EWWCCEL522358 | 1072 | 488 | 959 | 52 | 23 | 58 |
| | EWWCCEL522364 | 1153 | 536 | 1054 | 52 | 23 | 64 |
| | EWWCCEL522370 | 1235 | 583 | 1151 | 52 | 23 | 70 |
| | EWWCCEL522376 | 1399 | 682 | 1344 | 52 | 23 | 76 |
| | EWWCCEL522382 | 1566 | 779 | 1533 | 52 | 23 | 82 |
| EWWCCEL582364 | 1179 | 535 | 1054 | 58 | 23 | 64 | |
| EWWCCEL582370 | 1268 | 589 | 1160 | 58 | 23 | 70 | |
| EWWCCEL582376 | 1470 | 697 | 1371 | 58 | 23 | 76 | |
| EWWCCEL582382 | 1668 | 811 | 1599 | 58 | 23 | 82 | |
| EWWCCEL462958 | 968 | 280 | 901 | 46 | 29 | 58 | |
| EWWCCEL462964 | 1053 | 307 | 986 | 46 | 29 | 64 | |
| EWWCCEL462970 | 1144 | 329 | 1061 | 46 | 29 | 70 | |
| EWWCCEL462976 | 1229 | 355 | 1146 | 46 | 29 | 76 | |
| EWWCCEL462982 | 1296 | 374 | 1209 | 46 | 29 | 82 | |
| EWWCCEL522958 | 1114 | 505 | 998 | 52 | 29 | 58 | |
| EWWCCEL522964 | 1198 | 558 | 1097 | 52 | 29 | 64 | |
| EWWCCEL522970 | 1285 | 608 | 1195 | 52 | 29 | 70 | |
| EWWCCEL522976 | 1456 | 709 | 1395 | 52 | 29 | 76 | |
| EWWCCEL522982 | 1627 | 810 | 1595 | 52 | 29 | 82 | |
| EWWCCEL582964 | 1260 | 580 | 1142 | 58 | 29 | 64 | |
| EWWCCEL582970 | 1349 | 634 | 1247 | 58 | 29 | 70 | |
| EWWCCEL582976 | 1528 | 739 | 1454 | 58 | 29 | 76 | |
| EWWCCEL582982 | 1709 | 844 | 1660 | 58 | 29 | 82 | |



EWWCER - EXTENDED CORNER WORKSURFACE - HEIGHT ADJUSTABLE

- Support hardware must be ordered separately. See listing in this section of the price book.
- There is no scoop in this worksurface.

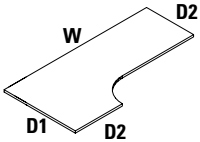
| DESCRIPTION | PRODUCT CODE | LP | PRICE | | DIMENSIONS/INCHES | | |
|--|--------------|------|--------|---------|-------------------|----|----|
| | | | HP ADD | HPW ADD | D1 | D2 | W |
|  Extended Corner Worksurface | EWWCER462358 | 917 | 218 | 785 | 46 | 23 | 58 |
| | EWWCER462364 | 988 | 272 | 906 | 46 | 23 | 64 |
| | EWWCER462370 | 1062 | 317 | 1004 | 46 | 23 | 70 |
| | EWWCER462376 | 1165 | 306 | 1039 | 46 | 23 | 76 |
| | EWWCER462382 | 1215 | 348 | 1122 | 46 | 23 | 82 |
| | EWWCER522358 | 1072 | 488 | 959 | 52 | 23 | 58 |
| | EWWCER522364 | 1153 | 536 | 1054 | 52 | 23 | 64 |
| | EWWCER522370 | 1235 | 583 | 1151 | 52 | 23 | 70 |
| | EWWCER522376 | 1399 | 682 | 1344 | 52 | 23 | 76 |
| | EWWCER522382 | 1566 | 779 | 1533 | 52 | 23 | 82 |
| EWWCER582364 | 1179 | 535 | 1054 | 58 | 23 | 64 | |
| EWWCER582370 | 1268 | 589 | 1160 | 58 | 23 | 70 | |
| EWWCER582376 | 1470 | 697 | 1371 | 58 | 23 | 76 | |
| EWWCER582382 | 1668 | 811 | 1599 | 58 | 23 | 82 | |
| EWWCER462958 | 968 | 280 | 901 | 46 | 29 | 58 | |
| EWWCER462964 | 1053 | 307 | 986 | 46 | 29 | 64 | |
| EWWCER462970 | 1144 | 329 | 1061 | 46 | 29 | 70 | |
| EWWCER462976 | 1229 | 355 | 1146 | 46 | 29 | 76 | |
| EWWCER462982 | 1296 | 374 | 1209 | 46 | 29 | 82 | |
| EWWCER522958 | 1114 | 505 | 998 | 52 | 29 | 58 | |
| EWWCER522964 | 1198 | 558 | 1097 | 52 | 29 | 64 | |
| EWWCER522970 | 1285 | 608 | 1195 | 52 | 29 | 70 | |
| EWWCER522976 | 1456 | 709 | 1395 | 52 | 29 | 76 | |
| EWWCER522982 | 1627 | 810 | 1595 | 52 | 29 | 82 | |
| EWWCER582964 | 1260 | 580 | 1142 | 58 | 29 | 64 | |
| EWWCER582970 | 1349 | 634 | 1247 | 58 | 29 | 70 | |
| EWWCER582976 | 1528 | 739 | 1454 | 58 | 29 | 76 | |
| EWWCER582982 | 1709 | 2551 | 3369 | 58 | 29 | 82 | |

EVWS - EXTENDED CURVED CORNER RETURN - HEIGHT ADJUSTABLE

- Support hardware must be ordered separately. See listing in this section of the price book.
- There is no scoop in this worksurface.

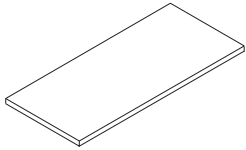
| | DESCRIPTION | PRODUCT CODE | PRICE | | | DIMENSIONS/INCHES | |
|---|-----------------------------|--------------|-------|--------|---------|-------------------|----|
| | | | LP | HP ADD | HPW ADD | D | W |
|  | Extended Corner Worksurface | EVWS2324 | 149 | 55 | 154 | 23 | 24 |
| | | EVWS2336 | 159 | 59 | 167 | 23 | 36 |
| | | EVWS2348 | 180 | 68 | 186 | 23 | 38 |
| | | EVWS2924 | 175 | 64 | 182 | 23 | 24 |
| | | EVWS2936 | 185 | 76 | 205 | 23 | 36 |
| | | EVWS2948 | 219 | 84 | 231 | 23 | 48 |

EVWC6C - 60 DEGREE CURVED CORNER WORKSURFACE - HEIGHT ADJUSTABLE

- Support hardware must be ordered separately. See listing in this section of the price book.
- There is no scoop in this worksurface.

| | DESCRIPTION | PRODUCT CODE | LIST PRICE | | | DIMENSIONS/INCHES | |
|---|---------------------------|--------------|------------|--------|---------|-------------------|----|
| | | | LP | HP ADD | HPW ADD | D | W |
|  | Curved Corner Worksurface | EVWC6C2346 | 1487 | 200 | 1042 | 23 | 46 |
| | | EVWC6C2352 | 1588 | 777 | 1533 | 23 | 52 |
| | | EVWC6C2946 | 1487 | 200 | 1042 | 29 | 46 |
| | | EVWC6C2952 | 1588 | 777 | 1533 | 29 | 52 |



EVTHLEG - EVOLVE BRIDGES LEG

- Leg assembly attaches to panel for application which requires functionality of panels with environment of bridges tables.
- One leg wit horizontal member connection to 1" increment slots in connector. Provides support to panel and panel connected worksurface at end of run- design coordinated with Bridges freestanding tables.
- Supports 24" and 30" deep worksurface
- One leg can support 2 adjoining worksurfaces by specifying 2 flat brackets.
- Leveling glides is standard
- No worksurface supporting beams, use panel cantilever and storage for worksurface support.
- One aluminum leg with steel structure - specify left or right and 24" or 30" deep for corresponding worksurface depth.
- Panel bracket, dislodgment clip and worksurface hardware included.
- Anodized aluminum upcharge \$32.00.
- Please specify paint finish.

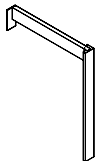
| | DESCRIPTION | PRODUCT CODE | LIST PRICE | DIMENSIONS/INCHES | | |
|---|--------------------|--------------|------------|-------------------|-----|----|
| | | | | H | D | W |
|  | Evolve Bridges Leg | EVTHLEG24LL | 439 | 29 | 2.5 | 24 |
| | | EVTHLEG24RL | 439 | 29 | 2.5 | 24 |
| | | EVTHLEG30LL | 460 | 29 | 2.5 | 30 |
| | | EVTHLEG30RL | 460 | 29 | 2.5 | 30 |

EVHPL - EVOLVE PRINCETON LEG

- Princeton leg supports Evolve worksurfaces
- Includes leveling glides
- Legs must used with exact depth worksurfaces only
- Available in standard paint finishes

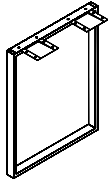
| | DESCRIPTION | PRODUCT CODE | LIST PRICE | DIMENSIONS/INCHES | | |
|--|----------------------|--------------|------------|-------------------|------|----|
| | | | | H | D | W |
|  | Evolve Princeton Leg | EVHPL24 | 418 | 27.5 | 6.75 | 24 |
| | | EVHPL30 | 434 | 27.5 | 6.75 | 30 |

EVHPL - EVOLVE PRINCETON LEG WITH BRACKET

- Bracket attaches to back of Princeton leg and connects Princeton leg to panel connector
- Supports the worksurface and enhance stability of connected panels
- Includes levelling glides
- Available in standard paint finishes

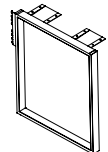
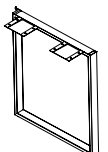
| | DESCRIPTION | PRODUCT CODE | LIST PRICE | DIMENSIONS/INCHES | | |
|---|---|--------------|------------|-------------------|------|----|
| | | | | H | D | W |
|  | Evolve Princeton Leg with Left Bracket | EVHPL24L | 460 | 27.5 | 6.75 | 24 |
| | | EVHPL30L | 475 | 27.5 | 6.75 | 30 |
|  | Evolve Princeton Leg with Right Bracket | EVHPL24R | 460 | 27.5 | 6.75 | 24 |
| | | EVHPL30R | 475 | 27.5 | 6.75 | 30 |

EVHMEGR - METAL END GABLE ROUND LEG - NO HANDED

- Support the worksurface and enhances the stability of connected panels.
- Includes a leveling glide and decorative PVC sleeve to cover the glide.
- Attaches to Evolve Panels connectors.
- Available in standard paint colors.
- Mounting bracket is universal (LH or RH), attached with screws to back of leg.
- Note: No sharing, please use EVHMSSL12 for sharing

| | DESCRIPTION | PRODUCT CODE | LIST PRICE | DIMENSIONS/INCHES | | |
|---|---------------------------|--------------|------------|-------------------|---|----|
| | | | | H | W | D |
|  | Metal End Gable Round Leg | EVHMEGR24 | 292 | 29 | 2 | 23 |
| | No Handed | EVHMEGR30 | 307 | 29 | 2 | 29 |

EVHMEGS - METAL END GABLE SQUARE LEG -NO HANDED

- Support the worksurface and enhances the stability of connected panels.
- Includes a leveling glide and decorative PVC sleeve to cover the glide.
- Attaches to Evolve Panels connectors.
- Available in standard paint colors.
- Mounting bracket is universal attached with screws to back of leg.

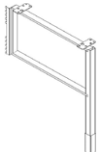
| | DESCRIPTION | PRODUCT CODE | LIST PRICE | DIMENSIONS/INCHES | | |
|---|---------------------------|--------------|------------|-------------------|---|----|
| | | | | H | W | D |
|  | Metal End Gable Round Leg | EVHMEGS24 | 258 | 29 | 2 | 23 |
| | No Handed | EVHMEGS30 | 274 | 29 | 2 | 29 |

EVHMSSL - METAL SUPPORT LEG

- Supports two adjoining worksurfaces and enhances the stability of connected panels.
- Includes a levelling glide and decorative PVC sleeve to cover the glide.
- Leveling glide may be extended up to 1 1/2" maximum.
- Flat brackets recommended to ensure alignment of neighboring surface.
- Available in standard paint colors.
- Not designed for use at the end of a worksurface.
- Handedness of support leg cannot be changed.
- Not designed to be used with radius worksurfaces.

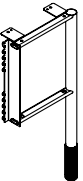
| | DESCRIPTION | PRODUCT CODE | LIST PRICE | DIMENSIONS/INCHES | | |
|---|-------------------|--------------|------------|-------------------|----|---|
| | | | | H | W | D |
|  | Metal Support Leg | EVHMSSL12 | 246 | 28 | 11 | 4 |

EVHMSSL - METAL SUPPORT SQUARE LEG

- Support two adjoining worksurfaces and enhances the stability of connected panels.
- Includes a leveling glide and decorative PVC sleeve to cover the glide.
- Attaches to Evolve Panels.
- Available in standard paint colors.

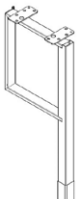
| | DESCRIPTION | PRODUCT CODE | LIST PRICE | DIMENSIONS/INCHES | | |
|---|--------------------------|--------------|------------|-------------------|---|----|
| | | | | H | W | D |
|  | Metal Support Square Leg | EVHMSSL12 | 222 | 29 | 2 | 11 |



EVHC - CANTILEVER FOR KEYBOARD WORKSURFACES

- Attaches a worksurface to a panel connector.
- Used to support two convergent worksurfaces.
- 2 flat brackets are included.
- Priced individually
- Specify handedness of each cantilever
- Available in standard paint colors.

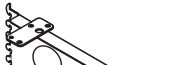
| | DESCRIPTION | PRODUCT CODE | LIST PRICE | DIMENSIONS/INCHES | |
|---|--------------------------------------|--------------|------------|-------------------|---|
| | | | | D | W |
|  | Cantilever for Keyboard Worksurfaces | EVHC12L/R | 110 | 12 | 6 |
| | | EVHC18L/R | 110 | 18 | 6 |
| | | EVHC24L/R | 126 | 24 | 6 |

EVHS - SUPPORT LEG

- Used in conjunction with a EVHC cantilever.
- Provides extra support where needed.
- Used to help support two convergent worksurfaces.
- Available in standard paint colors.

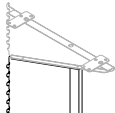
| | DESCRIPTION | PRODUCT CODE | LIST PRICE | DIMENSIONS/INCHES | | |
|---|---------------------|--------------|------------|-------------------|------|------|
| | | | | H | W | D |
|  | Support Leg - Left | EVHSL2918 | 102 | 23.38 | 0.75 | 12.5 |
| | | EVHSL2924 | 102 | 23.38 | 0.75 | 12.5 |
| | Support Leg - Right | EVHSR2918 | 102 | 23.38 | 0.75 | 12.5 |
| | | EVHSR2924 | 102 | 23.38 | 0.75 | 12.5 |

EVHCL - CORNER LEG WITH LEVELER

- Provides support for a worksurface.
- Includes leveling glide, PVC Sleeve and attachment plate.
- Leveling glide may be extended up to 1 1/2" maximum.
- 1.5" diameter
- Available in standard paint colors.
- Legs can be used in the corner of a single worksurface or be rotated 45 degrees to support the corners of two worksurfaces.

| | DESCRIPTION | PRODUCT CODE | LIST PRICE | DIMENSIONS/INCHES |
|---|-------------------|--------------|------------|-------------------|
| | | | | H |
|  | Corner Leg Round | EVHCL1 | 130 | 28 |
| | Corner Leg Square | EVHCL2 | 130 | 28 |

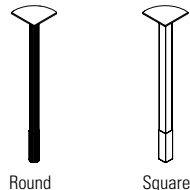

EVHMSL - MID SUPPORT LEG

- Provides support for a worksurface.
- Includes leveling glide, PVC Sleeve and 4.8" x 4.8" attachment plate.
- Leveling glide may be extended up to 1 1/2" maximum.
- 1.5" diameter.
- Available in standard paint colors.

| | DESCRIPTION | PRODUCT CODE | LIST PRICE | DIMENSIONS/INCHES |
|---|--------------------------|--------------|------------|-------------------|
| | | | | H |
|  | Mid Support Leg - Round | EVHMSL1 | 94 | 28 |
| | Mid Support Leg - Square | EVHMSL2 | 94 | 28 |

EVHMSL - MID SUPPORT LEG

- Provides additional support for worksurface.
- Includes leveling glide, PVC Sleeve and 4.8" x 4.8" attachment plate.
- 1.5" square tube.
- Available in standard paint colors.

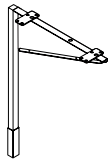
| | DESCRIPTION | PRODUCT CODE | LIST PRICE | DIMENSIONS/INCHES | | |
|---|--------------------------------------|--------------|------------|-------------------|----|-----|
| | | | | H | W | D |
|  | Mid Support Leg - Cantilever Bracket | EVHMSCL18 | 151 | 28 | 18 | 1.5 |

EVWS - 5" SURFACE TO STORAGE SUPPORT LEG

- Provides support for a worksurface.
- Includes leveling glide, PVC Sleeve and 4.8" x 4.8" attachment plate.
- 1.5" diameter.
- Available in standard paint colors.

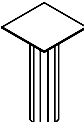
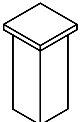
| | DESCRIPTION | PRODUCT CODE | LIST PRICE | DIMENSIONS/INCHES | | |
|---|--|--------------|------------|-------------------|---|---|
| | | | | H | W | D |
|  | 5" Surface to Storage Support Leg - Round | EVWSRL01 | 58 | 4.5 | | |
|  | 5" Surface to Storage Support Leg - Square | EVWSSL01 | 58 | 4.5 | | |

Round Square

EVHCB - CORNER BRACKETS

- Attaches the corner of any worksurface to a panel connector.
- Priced and shipped in pairs.
- Available in black only.

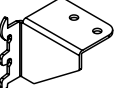
| | DESCRIPTION | PRODUCT CODE | LIST PRICE | DIMENSIONS/INCHES | |
|---|-----------------|--------------|------------|-------------------|-----|
| | | | | D | W |
|  | Corner Brackets | EVHCB2 | 31 | 2.5 | 3.5 |

EVHTB - TRANSACTION BRACKETS

- Securely attaches a transaction surface to the top of a panel.
- One pair must be on each side of transaction surface.
- Priced and shipped in pairs.
- Available in standard paint colors.

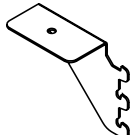
| | DESCRIPTION | PRODUCT CODE | LIST PRICE | DIMENSIONS/INCHES | |
|---|----------------------|--------------|------------|-------------------|-----|
| | | | | D | W |
|  | Transaction Brackets | EVHTB2 | 31 | 2.5 | 3.5 |



EVHFB - FLAT BRACKET

- Must be used in conjunction with cantilevers or transaction brackets to ensure alignment of neighboring surfaces.
- Available in Black only.
- Priced individually

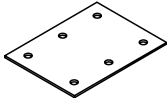
| | DESCRIPTION | PRODUCT CODE | LIST PRICE | DIMENSIONS/INCHES | |
|---|--------------|--------------|------------|-------------------|---|
| | | | | D | W |
|  | Flat Bracket | EVHFB1 | 21 | 3 | 4 |

EVHCFB1- TIE PLATE

- Must be used in conjunction with cantilever or transaction brackets to ensure alignment of neighboring surfaces.
- Available in black only.
- Aligns with threaded metal inserts in worksurfaces.
- Priced individually.

| | DESCRIPTION | PRODUCT CODE | LIST PRICE | DIMENSIONS/INCHES | |
|---|-------------|--------------|------------|-------------------|------|
| | | | | D | W |
|  | Tie Plate | EVHCFB1 | 21 | 1.5 | 3.36 |

EVHPB - PEDESTAL BRACKET

- Attaches to back edge of a pedestal and connects a pedestal to panel connector.
- Available in standard paint colors.

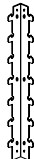
| | DESCRIPTION | PRODUCT CODE | LIST PRICE | DIMENSIONS/INCHES | |
|---|------------------|--------------|------------|-------------------|--|
| | | | | H | |
|  | Pedestal Bracket | EVHPB1 | 36 | 11 | |

EVHWSC - WORKSURFACE SUPPORT CHANNEL

- Support channel attaches to underside of worksurface with screws
- Support channel should be 14" shorter than top length.
- Screws are included.
- Only available in Black.
- Tops with post legs should be specified with support channel for structural reinforcement.

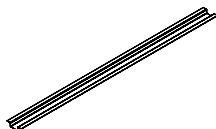
| | DESCRIPTION | PRODUCT CODE | LIST PRICE | DIMENSIONS/INCHES | |
|---|-----------------------------|-------------------------------|------------|-------------------|---|
| | | | | L | D |
|  | Worksurface Support Channel | EVHWSC40 - for 54" wide table | 80 | 40 | 5 |
| | | EVHWSC46 - for 60" wide table | 86 | 46 | 5 |
| | | EVHWSC52 - for 66" wide table | 92 | 52 | 5 |
| | | EVHWSC58 - for 72" wide table | 104 | 58 | 5 |
| | | EVHWSC64 - for 78" wide table | 116 | 64 | 5 |
| | | EVHWSC70 - for 84" wide table | 127 | 70 | 5 |

EVHWCB1 - WORKSURFACE TO STORAGE BRACKETS

- Bracket connects Worksurface to Storage Towers as additional support.
- Bracket EVHWCB1 cannot fully support a Worksurface. It is to be used in conjunction with a Cantilever.
- Available in standard paint colors.

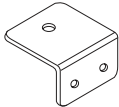
| | DESCRIPTION | PRODUCT CODE | LIST PRICE | DIMENSIONS/INCHES | | |
|---|---------------------------------|--------------|------------|-------------------|---|---|
| | | | | H | D | W |
|  | Worksurface to Storage Brackets | EVHWCB1 | 13 | 1.25 | 2 | 2 |

EVHV - SINGLE SLOTTED WALL ADAPTER

- To attach system components to a fixed wall. The vertical wall adapter is a “U” shaped channel with a vertical row of 1” slots on center.
 - Mounting hardware not included. Mounting hardware selection to be based on wall material.
 - Use of wall rack requires lower tooth of top hook on cantilever or shelf to be notched in the field.
 - Available in standard paint colors.
 - Shipped & priced per pair.
- NOTE:**
- Care should be taken to mount adapters only to wall studs using correct fasteners. Failure to do this may result in collapse of the unit and subsequent possible personal injury.

| | DESCRIPTION | PRODUCT CODE | LIST PRICE | DIMENSIONS/INCHES | |
|--|---------------------------|--------------|------------|-------------------|----|
| | | | | H | D |
|  | Single Slotted Wall Track | EVHV01 | 92 | 60 | .5 |

EVDCP - CENTRAL SUPPORT PANEL

- Supports and connects 2 worksurfaces
- Includes two end panel brackets, two levelling glides and modesty inter connect bracket (EVDECCR)
- Attaches to modesty panel
- End panel height is inclusive of panel glides extended to their fullest height
- All Freestanding products are available in thermally fused thickness only.

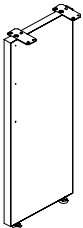
| | DESCRIPTION | PRODUCT CODE | LIST PRICE | DIMENSIONS/INCHES | |
|---|-----------------------|--------------|------------|-------------------|----|
| | | | | W | H |
|  | Central Support Panel | EVDCP2910 | 180 | 10 | 28 |
| | | EVDCP2914 | 227 | 14 | 28 |
| | | EVDCP2610 | 160 | 10 | 28 |
| | | EVDCP2614 | 213 | 14 | 28 |



EVDHMSB - MID SUPPORT BRACKET

- Provides mid support for worksurfaces
- Recommended for any lengths over 42"
- Available in black only.

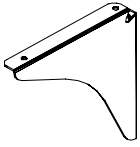
| | DESCRIPTION | PRODUCT CODE | LIST PRICE | DIMENSIONS/INCHES | | |
|---|---------------------|--------------|------------|-------------------|-------|-----|
| | | | | D | W | H |
|  | Mid Support Bracket | EVDHMSB | 55 | 7 1/2 | 7 1/2 | 1/2 |

EVDECCR - MODESTY INTER-CONNECT BRACKET

- Attaches two modesty panels to a mid support panel

| | DESCRIPTION | PRODUCT CODE | LIST PRICE | DIMENSIONS/INCHES | |
|---|-------------------------------|--------------|------------|-------------------|---|
| | | | | W | H |
|  | Modesty Inter-Connect Bracket | EVDECCR | 30 | 12 1/2 | 4 |

EVDHLB - END PANEL "L" BRACKET

- Attaches a modesty panel to an end panel
- Available in black only.

| | DESCRIPTION | PRODUCT CODE | LIST PRICE | DIMENSIONS/INCHES | | |
|---|-----------------------|--------------|------------|-------------------|----|-------|
| | | | | D | W | H |
|  | End Panel "L" Bracket | EVDHLB | 31 | 1 1/2 | 12 | 1 1/2 |

freestanding

EVWFR - RECTANGULAR FREESTANDING WORKSURFACE WITH CORNER LEGS

- Worksurface include 6 threaded-metal inserts in corners, to allow for metal-to-metal connections.
- Worksurface is available in 1-1/16" thick High Pressure laminate only.
- Legs are 1.5" diameter and include leveling glide, PVC sleeve and attachment plate. PVC sleeve available in Evolve standard colors only.
- Legs can be used in the corner of a single worksurface, or rotated 45 degrees to support the corners of two worksurfaces.
- Ships Knocked Down.
- All Freestanding products are available in thermally fused thickness only.

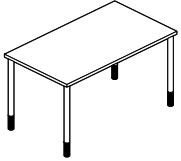
| | DESCRIPTION | PRODUCT CODE | LIST PRICE | DIMENSIONS/INCHES | | |
|---|--|--------------|------------|-------------------|----|----|
| | | | | D | W | H |
|  | Rectangular Freestanding Worksurface with Round Corner Legs | EWWFR2448HP | 888 | 24 | 48 | 29 |
| | | EWWFR2460HP | 1029 | 24 | 60 | 29 |
| | | EWWFR3048HP | 967 | 30 | 48 | 29 |
| | | EWWFR3060HP | 1058 | 30 | 60 | 29 |
|  | Rectangular Freestanding Worksurface with Square Corner Legs | EWFRS2448HP | 888 | 24 | 48 | 29 |
| | | EWFRS2460HP | 1029 | 24 | 60 | 29 |
| | | EWFRS3048HP | 967 | 30 | 48 | 29 |
| | | EWFRS3060HP | 1058 | 30 | 60 | 29 |

EVWFS - SQUARE FREESTANDING WORKSURFACE WITH CORNER LEGS

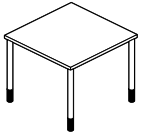
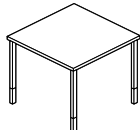

- Worksurface include 6 threaded-metal inserts in corners, to allow for metal-to-metal connections.
- Worksurface is available in 1-1/16" thick High Pressure laminate only.
- Legs are 1.5" diameter and include leveling glide, PVC sleeve and attachment plate. PVC sleeve available in Evolve standard colors only.
- Legs can be used in the corner of a single worksurface, or rotated 45 degrees to support the corners of two worksurfaces.
- Ships Knocked Down.
- All Freestanding products are available in thermally fused thickness only.

| | DESCRIPTION | PRODUCT CODE | LIST PRICE | DIMENSIONS/INCHES | | |
|---|---|--------------|------------|-------------------|----|----|
| | | | | D | W | H |
|  | Square Freestanding Worksurface with Round Corner Legs | EWWFS36HP | 939 | 36 | 36 | 29 |
| | | EWWFS42HP | 1077 | 42 | 42 | 29 |
| | | EWWFS48HP | 1272 | 48 | 48 | 29 |
|  | Square Freestanding Worksurface with Square Corner Legs | EWWFSS36HP | 939 | 36 | 36 | 29 |
| | | EWWFSS42HP | 1077 | 42 | 42 | 29 |
| | | EWWFSS48HP | 1272 | 48 | 48 | 29 |

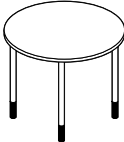

EWFC - ROUND FREESTANDING WORKSURFACE WITH CORNER LEGS

- Worksurface include 6 threaded-metal inserts in corners, to allow for metal-to-metal connections.
- Worksurface is available in 1-1/16" thick High Pressure laminate only.
- Legs are 1.5" diameter and include leveling glide, PVC sleeve and attachment plate.
- Legs can be used in the corner of a single worksurface, or rotated 45 degrees to support the corners of two worksurfaces.
- Ships Knocked Down.
- All Freestanding products are available in thermally fused thickness only.

| | DESCRIPTION | PRODUCT CODE | LIST PRICE | DIMENSIONS/INCHES | |
|---|--|--------------|------------|-------------------|----|
| | | | | W | H |
|  | Round Freestanding Worksurface with Corner Legs | EWFC36HP | 1001 | 36 | 29 |
| | | EWFC42HP | 1204 | 42 | 29 |
| | | EWFC48HP | 1436 | 48 | 29 |
|  | Round Freestanding Worksurface with Square Corner Legs | EWFCS36HP | 1001 | 36 | 29 |
| | | EWFCS42HP | 1204 | 42 | 29 |
| | | EWFCS48HP | 1436 | 48 | 29 |

storage

PRIME FILE FEATURES

- **THE LETTER "P" IN THE MODEL NUMBER DESIGNATES FULL PULL MODELS.**
- An earth friendly electrostatically applied coating protects the environment and provides a durable finish.
- Master keys and core keys are available; please contact your Global customer care representative.
- Five lateral file drawer configurations are available: two-high, three-high, four-high, five-high and six-high, all available in three height options (with the exception of the six-high cabinet which is available in letter-height only).
- STANDARD LOCK BARS ARE ON BOTH SIDES OF CABINET PROVIDING INCREASED SECURITY.
- A patented interlocking system prevents more than one drawer opening at a time to guard against tipping.
- An optional, fully-retractable posting shelf is available for five- and six-high lateral file cabinets to provide a convenient ledge.
- All drawer heights are based on a 1.6" module (the size of the posting shelf), then 3.2", 4.8", 6.4" to up to 16".
- The interior construction of the case permits drawer reconfiguration or retrofit at any time.
- Full extension ball bearing suspension with built-in feature to prevent drawer bounce back and creepage.
- 14.4"H Openings (with receding doors) will accommodate letter, legal and A4 hanging folders, plus STANDARD THREE RING BINDERS.
- 13.6"H Openings (with fixed drawer fronts) will accommodate letter, legal and A4 hanging folders, plus EDP SUSPENDED DATA BINDERS.
- 11.2"H Openings (with receding doors or fixed drawer fronts) will accommodate letter, legal or A4 hanging file folders.
- **DRAWER FRONTS HAVE A WELDED REINFORCEMENT CHANNEL FOR ADDITIONAL STRENGTH.**
- Four adjustable leveling glides are easily accessible from inside the cabinet to assist in quick and proper installation, with 1" adjustment.
- Label holders are included with full pull fronts to clearly identify the contents of each drawer.
- All lateral file accessories are Grey, except for the divider plates and EDP adapters are Black.
- Side-to-side hanging file bars permit hanging letter-, legal- or metric-size files in side-to-side arrangements
- Front-to-back file bars permit hanging letter-, legal- or metric-size files in a front-to-back arrangement. They are shipped in packages of two.
- **Counterweights are required for all cabinets with pull-out drawers and cabinets not located directly under a worksurface.**
- For environmental certifications, please visit globalfurnituregroup.com
- Lifetime Warranty. (See Terms and Conditions)

STANDARD PAINT COLORS

| | | |
|----------------------|------------------|----------------|
| Black (BLK) | Blizzard (BZD) | Charcoal (CHR) |
| Designer White (DWT) | Fog (FOG) | Nevada (NEV) |
| Silver (SIL) | Stone Dust (SDT) | Taupe (TPE) |
| Tungsten (TUN)* | | |

*10% upcharge applies.

PREMIUM PAINT COLORS**

| | | |
|--------------------|----------------------|---------------------|
| Black Coffee (BKC) | Bone (BNE) | Business Grey (BGR) |
| Claret (CLT) | Dark Chocolate (DCH) | Desert Putty (DPT) |
| Grey (GRY) | Ice (ICE) | Ivory (IVR) |
| Light Grey (LGR) | Metro (ME) | Mocha (MCH) |
| Moss (MOS) | Navy (NVY) | Oyster (OYS) |
| Sky (SKY) | Stone (STN) | Storm Grey (SGR) |
| Tahiti Sand (TSA) | Willow (WIL) | |

- **Extended lead times for premium paints apply. Contact Evolve Customer Support for details.
- Global matte paint finishes are available on most Evolve Storage pieces without an up charge regardless of quantities.
- All Mica and Metallic paint finishes will incur a minimum up charge of 10%.
- All non-standard paint finishes must be approved by Evolve prior to placing an order.

GENERAL WARRANTY INFORMATION

- Evolve warrants all components of metal storage and filing for the lifetime of the product to the original purchaser.





This page provides a three dimensional view of a sample configuration highlighting each storage component required when specifying this configuration.

Components

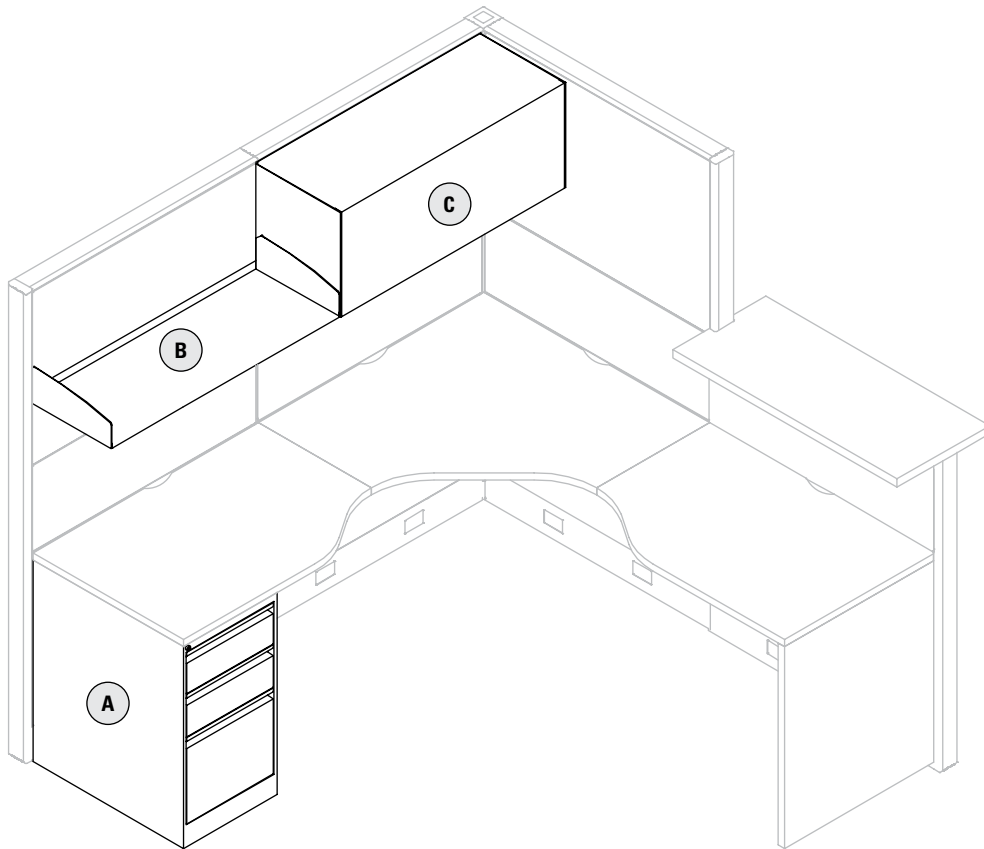
- A. UUPFSBG Box, Box, File Pedestal
- B. UUKSS Low-Profile Shelf
- C. UULSF Overhead Flipper Door Storage Unit

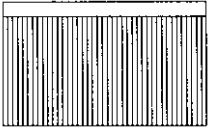
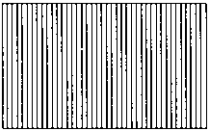
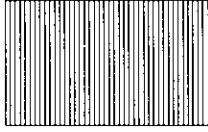
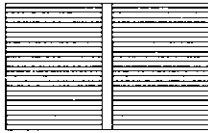
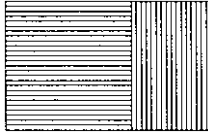
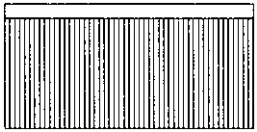
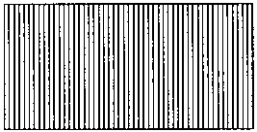
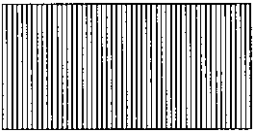
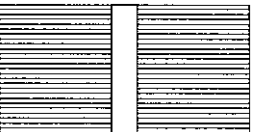
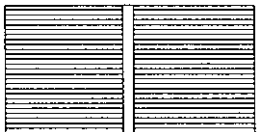
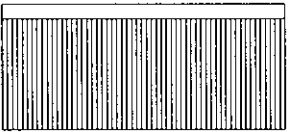
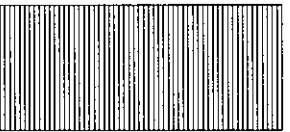
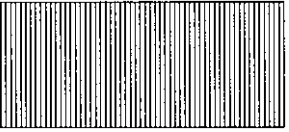
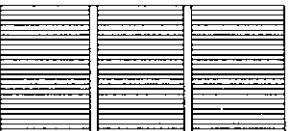

INTERIOR CLEAR OPENING WIDTH DIMENSIONS AND FILING CAPACITY

| | Letter | Legal | EDP |
|---|--|--|---|
| <p>30" Wide Units side-to-side</p> <p>UULFA01 side-to-side file bars are included in standard product.</p> |  <p>Capacity - 26 ⁵/₈"</p> |  <p>Capacity - 26 ⁵/₈"</p> |  <p>Capacity - 26 ⁵/₈" Need ONE pair of EDPs.</p> |
| | <p>30" Wide Units front-to-back</p> <p>Not Standard See chart to order the correct number of UULFA0718 per drawer.</p>  <p>Prime - 30 ¹/₂" Need ONE pair of UULFA01 & UULFA0718</p> |  <p>Prime - 15 ¹/₄" + 10" side space Need ONE pair of UULFA01 & UULFA0718</p> | <p>NOT AVAILABLE</p> |
| <p>36" Wide Units side-to-side</p> <p>UULFA02 side-to-side file bars are included in standard product.</p> |  <p>Capacity - 32 ⁵/₈"</p> |  <p>Capacity - 32 ⁵/₈"</p> |  <p>Capacity - 32 ⁵/₈" Need ONE pair EDPs.</p> |
| | <p>36" Wide Units front-to-back</p> <p>Not Standard See chart to order the correct number of UULFA0718 per drawer.</p>  <p>Prime - 30 ¹/₂" + 6 ¹/₂" side space Need ONE pair of ULFA02 & UULFA0718</p> |  <p>Prime - 30 ¹/₂" Need ONE pair of UULFA02 & UULFA0718</p> | <p>NOT AVAILABLE</p> |
| <p>42" Wide Units side-to-side</p> <p>UULFA03 side-to-side file bars are included in standard product.</p> |  <p>Capacity - 38 ⁵/₈"</p> |  <p>Capacity - 38 ⁵/₈"</p> |  <p>Capacity - 38 ⁵/₈" Need ONE pair EDPs.</p> |
| | <p>42" Wide Units front-to-back</p> <p>Not Standard See chart to order the correct number of UULFA0718 per drawer.</p>  <p>Prime - 45 ³/₄" Need TWO pairs of UULFA03 & UULFA0718</p> |  <p>Prime - 30 ¹/₂" + 6 ¹/₂" side space Need TWO pairs of UULFA03 & UULFA0718</p> | <p>NOT AVAILABLE</p> |



UULSF - OVERHEAD FLIPPER DOOR STORAGE UNIT

- Door retracts inside of cabinet.
- Ships fully assembled.
- Inside depth: 12.7".
- Lock is included.

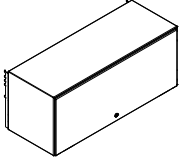
| | DESCRIPTION | PRODUCT CODE | LIST PRICE | DIMENSIONS/INCHES | | |
|---|------------------------------------|--------------|------------|-------------------|------|----|
| | | | | H | D | W |
|  | Overhead Flipper Door Storage Unit | UULSF1324 | 693 | 14.6 | 13.5 | 24 |
| | | UULSF1330 | 703 | 14.6 | 13.5 | 30 |
| | | UULSF1336 | 725 | 14.6 | 13.5 | 36 |
| | | UULSF1342 | 763 | 14.6 | 13.5 | 42 |
| | | UULSF1348 | 813 | 14.6 | 13.5 | 48 |
| | | UULSF1354 | 860 | 14.6 | 13.5 | 54 |
| | | UULSF1360 | 907 | 14.6 | 13.5 | 60 |

UULSF - OVERHEAD FLIPPER DOOR STORAGE UNIT

- Inside depth: 15.7".
- Ships fully assembled.
- Door retracts inside storage unit.
- Lock is included.

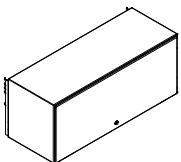
| | DESCRIPTION | PRODUCT CODE | LIST PRICE | DIMENSIONS/INCHES | | |
|--|--|--------------|------------|-------------------|------|----|
| | | | | H | D | W |
|  | Overhead Flipper Door Storage Unit - Fully Assembled | UULSF1624 | 918 | 14.6 | 16.5 | 24 |
| | | UULSF1630 | 941 | 14.6 | 16.5 | 30 |
| | | UULSF1636 | 988 | 14.6 | 16.5 | 36 |
| | | UULSF1642 | 1051 | 14.6 | 16.5 | 42 |
| | | UULSF1648 | 1119 | 14.6 | 16.5 | 48 |
| | | UULSF1654 | 1183 | 14.6 | 16.5 | 54 |
| | | UULSF1660 | 1232 | 14.6 | 16.5 | 60 |

EVS4DOH - LAMINATE OVERHEAD WITH HINGED DOOR

- Inside height - 13".
- Inside depth - 14".
- Laminate storage cabinet, available in standard Evolve laminate finishes.
- Hardware included to mount unit on the panels.
- Can be panel mounted or wall mounted.

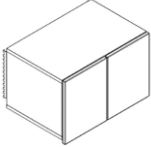
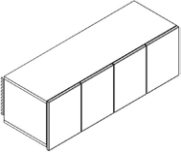
| | DESCRIPTION | PRODUCT CODE | LIST PRICE | DIMENSIONS/INCHES | | |
|---|--|--------------|------------|-------------------|------|----|
| | | | | H | D | W |
|  | Laminate Overhead with Two Hinged Doors | EVS4DOH24 | 1199 | 14.5 | 16.5 | 24 |
| | | EVS4DOH30 | 1364 | 14.5 | 16.5 | 30 |
| | | EVS4DOH36 | 1448 | 14.5 | 16.5 | 36 |
| | | EVS4DOH42 | 1631 | 14.5 | 16.5 | 42 |
|  | Laminate Overhead with Four Hinged Doors | EVS4DOH48 | 1818 | 14.5 | 16.5 | 48 |
| | | EVS4DOH54 | 2269 | 14.5 | 16.5 | 54 |
| | | EVS4DOH60 | 2353 | 14.5 | 16.5 | 60 |
| | | EVS4DOH66 | 2466 | 14.5 | 16.5 | 66 |
| | | EVS4DOH72 | 2522 | 14.5 | 16.5 | 72 |

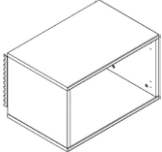
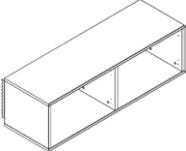

EVSOPOH - LAMINATE OVERHEAD OPEN

- Inside height - 13".
- Inside depth - 14".
- Laminate storage cabinet, available in standard Evolve laminate finishes.
- Hardware included to mount unit on the panels.
- Can be panel mounted or wall mounted.

| | DESCRIPTION | PRODUCT CODE | LIST PRICE | DIMENSIONS/INCHES | | |
|---|-----------------------------------|--------------|------------|-------------------|------|----|
| | | | | H | D | W |
|  | Laminate Overhead without Divider | EVSOPOH24 | 827 | 14.5 | 16.5 | 24 |
| | | EVSOPOH30 | 915 | 14.5 | 16.5 | 30 |
| | | EVSOPOH36 | 999 | 14.5 | 16.5 | 36 |
| | | EVSOPOH42 | 1084 | 14.5 | 16.5 | 42 |
|  | Laminate Overhead with Divider | EVSOPOH48 | 1284 | 14.5 | 16.5 | 48 |
| | | EVSOPOH54 | 1322 | 14.5 | 16.5 | 54 |
| | | EVSOPOH60 | 1406 | 14.5 | 16.5 | 60 |
| | | EVSOPOH66 | 1491 | 14.5 | 16.5 | 66 |
| | | EVSOPOH72 | 1575 | 14.5 | 16.5 | 72 |

EVS PDOH - LAMINATE OVERHEAD WITH SLIDING GLASS DOOR

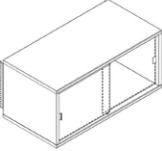
- Inside height - 13".
- Inside depth - 12.5".
- Laminate storage cabinet, available in standard Evolve laminate finishes.
- Available in Tempered Frosted Glass only, with handle.
- Tracks for sliding glass available in Tungsten only.
- Hardware included to mount unit on the panels.
- Can be panel mounted or wall mounted.

| | DESCRIPTION | PRODUCT CODE | LIST PRICE | DIMENSIONS/INCHES | | |
|---|-----------------------------------|--------------|------------|-------------------|------|----|
| | | | | H | D | W |
|  | Laminate Overhead without Divider | EVS PDOH24 | 2390 | 14.5 | 16.5 | 24 |
| | | EVS PDOH30 | 2589 | 14.5 | 16.5 | 30 |
| | | EVS PDOH36 | 2762 | 14.5 | 16.5 | 36 |
| | | EVS PDOH42 | 2947 | 14.5 | 16.5 | 42 |
|  | Laminate Overhead with Divider | EVS PDOH48 | 3190 | 14.5 | 16.5 | 48 |
| | | EVS PDOH54 | 3380 | 14.5 | 16.5 | 54 |
| | | EVS PDOH60 | 3559 | 14.5 | 16.5 | 60 |
| | | EVS PDOH66 | 3825 | 14.5 | 16.5 | 66 |
| | | EVS PDOH72 | 4050 | 14.5 | 16.5 | 72 |



EVSDAOH - DUAL ACCESS OVERHEAD

- Inside dimensions 13"high x 13"deep.
- Laminate Overhead. Available in standard Evolve laminate finishes
- Top mount on panels.
- Dual Access Overhead Support Brackets to be ordered separately.

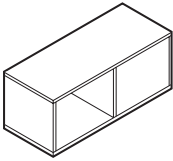
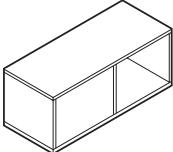
| | DESCRIPTION | PRODUCT CODE | LIST PRICE | DIMENSIONS/INCHES | | |
|---|------------------------------|--------------|------------|-------------------|--------|----|
| | | | | H | D | W |
|  | Dual Access Overhead - Left | EVSDAOHL36 | 1053 | 15 | 14.125 | 36 |
| | | EVSDAOHL42 | 1143 | 15 | 14.125 | 42 |
| | | EVSDAOHL48 | 1195 | 15 | 14.125 | 48 |
| | | EVSDAOHL54 | 1286 | 15 | 14.125 | 54 |
| | | EVSDAOHL60 | 1336 | 15 | 14.125 | 60 |
|  | Dual Access Overhead - Right | EVSDAOHR36 | 1053 | 15 | 14.125 | 36 |
| | | EVSDAOHR42 | 1143 | 15 | 14.125 | 42 |
| | | EVSDAOHR48 | 1195 | 15 | 14.125 | 48 |
| | | EVSDAOHR54 | 1286 | 15 | 14.125 | 54 |
| | | EVSDAOHR60 | 1336 | 15 | 14.125 | 60 |

EVSDAOHOS - DUAL ACCESS OVERHEAD WITH OPENING TO ONE SIDE

- Inside dimensions 13"high x 13"deep
- Laminate Overhead
- Available in standard Evolve laminate finishes
- Top mount on panels
- Dual Access Overhead with both opening to one side
- Dual Access Overhead Support Brackets to be ordered separately

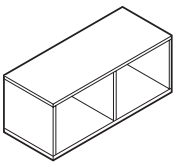
| | DESCRIPTION | PRODUCT CODE | LIST PRICE | DIMENSIONS/INCHES | | |
|--|----------------------|--------------|------------|-------------------|--------|----|
| | | | | H | D | W |
|  | Dual Access Overhead | EVSDAOHOS36 | 1104 | 15 | 14.125 | 36 |
| | | EVSDAOHOS42 | 1199 | 15 | 14.125 | 42 |
| | | EVSDAOHOS48 | 1253 | 15 | 14.125 | 48 |
| | | EVSDAOHOS54 | 1348 | 15 | 14.125 | 54 |
| | | EVSDAOHOS60 | 1403 | 15 | 14.125 | 60 |

EVSDAOHBKTE - END OF RUN BRACKET

- Bracket supports dual access overhead on one side only
- Includes one bracket, aluminum insert and end of run plastic cap
- End of run plastic cap attaches to end of run trim
- Bracket available in standard Evolve paint finishes

| | DESCRIPTION | PRODUCT CODE | LIST PRICE | DIMENSIONS/INCHES | | |
|---|---------------------------|--------------|------------|-------------------|----|---|
| | | | | H | D | W |
|  | End of Run Single Bracket | EVSDAOHBKTE | 94 | 6.5 | 12 | |

EVSDAOHCBKTER/L - END OF RUN CANTILEVER BRACKET

- Bracket supports dual access overhead on one side only
- Includes one bracket, aluminum insert and end of run plastic cap
- End of run plastic cap attaches to end of run trim
- Bracket available in standard Evolve paint finishes
- Bracket overhang to one side

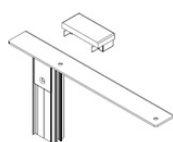
| | DESCRIPTION | PRODUCT CODE | LIST PRICE | DIMENSIONS/INCHES | | |
|---|---------------------------------|---------------|------------|-------------------|----|-----|
| | | | | H | D | W |
|  | End of Run Single Bracket Right | EVSDAOHCBKTER | 94 | 6.5 | 12 | 2.5 |
| | End of Run Single Bracket Left | EVSDAOHCBKTEL | 94 | 6.5 | 12 | 2.5 |

EVSDAOHBKTS - INLINE SINGLE BRACKET

- Bracket supports dual access overhead on one side only
- Includes one bracket , aluminum insert and inline plastic cap
- Inline plastic cap and top trim align
- Bracket available in standard Evolve paint finishes
- Single clamps must be used when inline single bracket is used

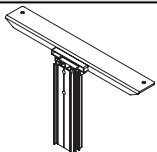
| DESCRIPTION | PRODUCT CODE | LIST PRICE | DIMENSIONS/INCHES | | |
|--|--------------|------------|-------------------|----|-----|
| | | | H | D | W |
|  Inline Single Bracket | EVSDAOHBKTS | 94 | 6.5 | 12 | 2.5 |

EVSDAOHCBKTSR/L - INLINE SINGLE CANTILEVER BRACKET

- Bracket supports dual access overhead on one side only
- Includes one bracket , aluminum insert and inline plastic cap
- Inline plastic cap and top trim align
- Bracket available in standard Evolve paint finishes
- Bracket overhang to one side
- Note: Single clamps must be used when inline single bracket is used

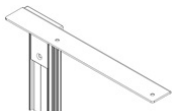
| DESCRIPTION | PRODUCT CODE | LIST PRICE | DIMENSIONS/INCHES | | |
|--|---------------|------------|-------------------|----|-----|
| | | | H | D | W |
|  Inline Single Bracket Right | EVSDAOHCBKTSR | 94 | 6.5 | 12 | 2.5 |
| Inline Single Bracket Left | EVSDAOHCBKTSL | 94 | 6.5 | 12 | 2.5 |

EVSDAOHBKTD - DOUBLE BRACKET

- Double Bracket supports sides of dual access overheads when overhead are side by side.
- Includes two brackets, aluminum insert and plastic caps.
- Plastic caps installed between brackets
- Brackets available in standard Evolve paint finishes.
- Single clamps must be used when double bracket is used.

| DESCRIPTION | PRODUCT CODE | LIST PRICE | DIMENSIONS/INCHES | | |
|---|--------------|------------|-------------------|----|---|
| | | | H | D | W |
|  Double Bracket | EVSDAOHBKTD | 186 | 6.5 | 12 | 4 |

EVSDAOHCBKTD - DOUBLE CANTILEVER BRACKET

- Double Bracket supports sides of dual access overheads when overhead are side by side
- Includes two brackets, aluminum insert and plastic caps
- Plastic caps installed between brackets
- Brackets available in standard Evolve paint finishes
- Bracket overhang to one side
- Note: Single clamps must be used when double bracket is used

| DESCRIPTION | PRODUCT CODE | LIST PRICE | DIMENSIONS/INCHES | | |
|---|--------------|------------|-------------------|----|---|
| | | | H | D | W |
|  Double Bracket | EVSDAOHCBKTD | 186 | 6.5 | 12 | 4 |



EVSSOH - TOP MOUNT KD OVERHEAD WITH SLIDING GLASS DOOR LEFT

- Inside dimensions 13”high x 13”deep.
- Laminate Side Walls and Divider, available in standard laminate finishes
- Metal Shelves and Back Wall, available in standard paint finishes
- Available in Temperate Frosted Glass only
- Tracks for sliding glass available in Tungsten only
- Top mount on panels
- Ready for quick assembly on site
- Top Mount Overhead Support Brackets to be ordered separately

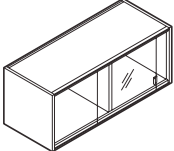
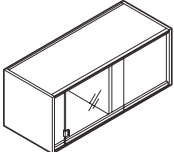
| | DESCRIPTION | PRODUCT CODE | LIST PRICE | DIMENSIONS/INCHES | | |
|---|-------------------------------|--------------|------------|-------------------|----|----|
| | | | | H | D | W |
|  | Top Mount KD Overhead - Left | EVSSOHL30 | 1153 | 15 | 15 | 30 |
| | | EVSSOHL36 | 1275 | 15 | 15 | 36 |
| | | EVSSOHL42 | 1403 | 15 | 15 | 42 |
| | | EVSSOHL48 | 1492 | 15 | 15 | 48 |
| | | EVSSOHL54 | 1582 | 15 | 15 | 54 |
| | | EVSSOHL60 | 1726 | 15 | 15 | 60 |
|  | Top Mount KD Overhead - Right | EVSSOHR30 | 1153 | 15 | 15 | 30 |
| | | EVSSOHR36 | 1275 | 15 | 15 | 36 |
| | | EVSSOHR42 | 1403 | 15 | 15 | 42 |
| | | EVSSOHR48 | 1492 | 15 | 15 | 48 |
| | | EVSSOHR54 | 1582 | 15 | 15 | 54 |
| | | EVSSOHR60 | 1726 | 15 | 15 | 60 |

EVSSOHBKTEE - END OF RUN BRACKET

- Bracket supports Top mount KD overhead on one side only
- Includes one bracket , aluminum insert and end of run plastic cap
- End of run plastic cap attaches to end of run trim
- Bracket available in standard Evolve paint finishes

| | DESCRIPTION | PRODUCT CODE | LIST PRICE | DIMENSIONS/INCHES | | |
|---|---------------------------|--------------|------------|-------------------|----|-----|
| | | | | H | D | W |
|  | End of Run Single Bracket | EVSSOHBKTE | 94 | 7.5 | 12 | 1.5 |

EVSSOHBKTS - INLINE SINGLE BRACKET

- Bracket supports Top mount KD overhead on one side only
- Includes one bracket , aluminum insert and inline plastic cap
- Inline plastic cap and top trim align
- Bracket available in standard Evolve paint finishes
- Single clamps must be used when inline single bracket is used

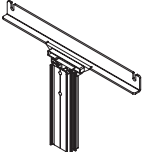
| | DESCRIPTION | PRODUCT CODE | LIST PRICE | DIMENSIONS/INCHES | | |
|---|-----------------------|--------------|------------|-------------------|----|-----|
| | | | | H | D | W |
|  | Inline Single Bracket | EVSSOHBKTS | 94 | 7.5 | 12 | 1.5 |

EVSSOHBKTD - DOUBLE BRACKET

- Double Bracket supports sides of Top Mount KD overheads when overhead are side by side
- Includes two brackets, aluminum insert and plastic caps
- Plastic caps installed between brackets
- Brackets available in standard Evolve paint finishes
- Single clamps must be used when double bracket is used

| DESCRIPTION | PRODUCT CODE | LIST PRICE | DIMENSIONS/INCHES | | |
|-------------|--------------|------------|-------------------|---|---|
| | | | H | D | W |

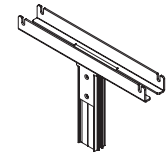

| | | | | | |
|----------------|------------|-----|-----|----|---|
| Double Bracket | EVSSOHBKTD | 186 | 7.5 | 12 | 2 |
|----------------|------------|-----|-----|----|---|

EVPIECH - 12 "H CHANNEL

- 12" channel to attach panel to side of center mount overhead
- Attaches with wood screws to side of installed center mount overhead with laminate sides
- Includes 12 "H channel and connecting hardware

| DESCRIPTION | PRODUCT CODE | LIST PRICE | DIMENSIONS/INCHES | | |
|-------------|--------------|------------|-------------------|---|---|
| | | | H | D | W |

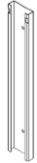

| | | | | | |
|-------------|-----------|----|----|---|--|
| 12" Channel | EVPIECH12 | 49 | 12 | 3 | |
|-------------|-----------|----|----|---|--|

EVADA-PM - EASY-UP OVERHEAD STORAGE UNIT

- Panel Mounted Overhead Storage with metal sides and opaque door that retracts on top of the unit
- Meets CSA B651 Barrier Free Design & ADA (American Disabilities Act).
- 16" high units accept standard and A4 binders.
- All shelves are reinforced for proper weight distribution.
- Inside dimensions: 14.25" high x 12" deep.
- Unit includes attachment hardware, lock and mounting brackets. Back not included.
- Not recommended for use with wall adapter.
- Unit can be converted into an upmount unit in the field by using EVADAxxKIT.
- Shipped partially assembled.
- Available in standard Evolve paint colors only. Door made of opaque plastic. **add 10% upcharge for Tungsten

| DESCRIPTION | PRODUCT CODE | LIST PRICE | DIMENSIONS/INCHES | | |
|-------------|--------------|------------|-------------------|---|---|
| | | | H | D | W |

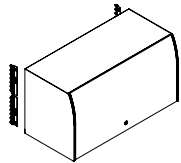

| | | | | | |
|-------------------------------|-----------|------|----|------|----|
| Easy-Up Overhead Storage Unit | EVADA30PM | 1230 | 16 | 14.2 | 30 |
| | EVADA36PM | 1327 | 16 | 14.2 | 36 |
| | EVADA42PM | 1416 | 16 | 14.2 | 42 |
| | EVADA48PM | 1512 | 16 | 14.2 | 48 |
| | EVADA54PM | 1608 | 16 | 14.2 | 54 |
| | EVADA60PM | 1700 | 16 | 14.2 | 60 |



EVADA-UM - EASY-UP UPMOUNT OVERHEAD STORAGE UNIT

- Meets CSA B651 Barrier Free Design & ADA (American Disabilities Act).
- 16" high units accept standard and A4 binders.
- All shelves are reinforced for proper weight distribution.
- Inside dimensions: 14.25" high x 12" deep.
- Unit includes attachment hardware, lock, mounting cantilevers and has a complete back.
- Shipped partially assembled.
- Available in standard Evolve paint colors only. Door made of opaque plastic.

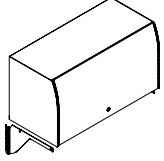
| | DESCRIPTION | PRODUCT CODE | LIST PRICE | DIMENSIONS/INCHES | | |
|---|---------------------------------------|--------------|------------|-------------------|------|----|
| | | | | H | D | W |
|  | Easy-Up Upmount Overhead Storage Unit | EVADA30UM | 1458 | 16 | 14.2 | 30 |
| | | EVADA36UM | 1527 | 16 | 14.2 | 36 |
| | | EVADA42UM | 1612 | 16 | 14.2 | 42 |
| | | EVADA48UM | 1696 | 16 | 14.2 | 48 |
| | | EVADA54UM | 1785 | 16 | 14.2 | 54 |
| | | EVADA60UM | 1884 | 16 | 14.2 | 60 |

UUKSS - LOW-PROFILE SHELF

- 12" deep panel-mounted storage shelf with back lip.
- Includes attachment hardware.
- Ships ready to assemble.

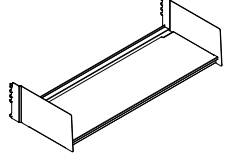
| | DESCRIPTION | PRODUCT CODE | LIST PRICE | DIMENSIONS/INCHES | | |
|---|-------------------|--------------|------------|-------------------|------|----|
| | | | | H | D | W |
|  | Low Profile Shelf | UUKSS24 | 141 | 7.5 | 14.7 | 24 |
| | | UUKSS30 | 151 | 7.5 | 14.7 | 30 |
| | | UUKSS36 | 167 | 7.5 | 14.7 | 36 |
| | | UUKSS42 | 172 | 7.5 | 14.7 | 42 |
| | | UUKSS48 | 180 | 7.5 | 14.7 | 48 |
| | | UUKSS54 | 187 | 7.5 | 14.7 | 54 |
| | | UUKSS60 | 196 | 7.5 | 14.7 | 60 |

EVSLs - LAMINATED SHELF

- Laminated panel mounted wood shelf
- Shelf thickness is 1".
- Available in LP only.
- Includes attachment hardware.

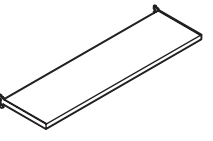
| | DESCRIPTION | PRODUCT CODE | LIST PRICE | DIMENSIONS/INCHES | | |
|---|-----------------|--------------|------------|-------------------|----|-----|
| | | | | H | W | D |
|  | Laminated Shelf | EVSLs0818 | 216 | 1.125 | 18 | 8.5 |
| | | EVSLs0824 | 233 | 1.125 | 24 | 8.5 |
| | | EVSLs0830 | 251 | 1.125 | 30 | 8.5 |
| | | EVSLs0836 | 269 | 1.125 | 36 | 8.5 |
| | | EVSLs0842 | 290 | 1.125 | 42 | 8.5 |
| | | EVSLs0848 | 306 | 1.125 | 48 | 8.5 |

EVHV - SINGLE SLOTTED WALL ADAPTER

- To attach system components to a fixed wall. The vertical wall adapter is a "U" shaped channel with a vertical row of 1" slots on center.
- Mounting hardware not included. Mounting hardware selection to be based on wall material.
- Use of wall rack requires lower tooth of top hook on cantilever or shelf to be notched in the field.

- Available in standard paint colors.
- Shipped & priced per pair.

NOTE:

- Care should be taken to mount adapters only to wall studs using correct fasteners. Failure to do this may result in collapse of the unit and subsequent possible personal injury.

| DESCRIPTION | PRODUCT CODE | LIST PRICE | DIMENSIONS/INCHES | |
|-------------|--------------|------------|-------------------|---|
| | | | D | H |



Single Slotted Wall Track

EVHV01

92

60

.5

EVADA-KIT - UPMOUNT CONVERSION KIT

- Converts an existing panel overhead storage unit EVADA-PM to an upmounted unit (EVADA-UM).
- When used on a 54" high panel, the top of the overhead will match the height of 66" high panels.

- Kit includes a back panel for the overhead and cantilevers.

| DESCRIPTION | PRODUCT CODE | LIST PRICE | DIMENSIONS/INCHES | | |
|-------------|--------------|------------|-------------------|---|---|
| | | | H | D | W |

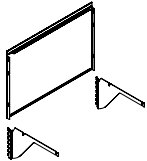

Upmount Conversion Kit

EVADA30KIT

260

16

30

2

EVADA36KIT

274

16

36

2

EVADA42KIT

289

16

42

2

EVADA48KIT

303

16

48

2

EVADA54KIT

316

16

54

2

EVADA60KIT

332

16

60

2

EVADAPMKIT - PANEL MOUNT CONVERSION KIT

- Converts an existing up mount overhead storage unit EVADA-UM to a panel mounted overhead storage unit EVADA-PM.
- Kit includes panel mounted brackets.

| DESCRIPTION | PRODUCT CODE | LIST PRICE | DIMENSIONS/INCHES | | |
|-------------|--------------|------------|-------------------|---|---|
| | | | H | D | W |



Panel Mount Conversion Kit

EVADAPMKIT

61

16

2

.5



EVSOIB - INTERNATIONAL OVERHEAD BACK WALL

- Metal back wall attaches to EVSOF17 overhead to provide interior security.
- Can be field installed or retrofitted.

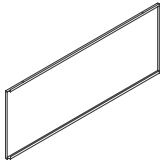
| | DESCRIPTION | PRODUCT CODE | LIST PRICE | DIMENSIONS/INCHES | | |
|---|----------------------------------|--------------|------------|-------------------|----|----|
| | | | | H | D | W |
|  | International Overhead Back Wall | EVSOIB24 | 76 | 17 | .5 | 24 |
| | | EVSOIB30 | 92 | 17 | .5 | 30 |
| | | EVSOIB36 | 99 | 17 | .5 | 36 |
| | | EVSOIB42 | 115 | 17 | .5 | 42 |
| | | EVSOIB48 | 126 | 17 | .5 | 48 |

CS19XXBBF - WORKSURFACE SUPPORTING BOX/BOX/FILE 15" PEDESTAL

- Worksurface supporting, with predrilled holes in the top.
- Also available as freestanding with finished top.
- All drawer fronts feature a recessed, angled full pull.
- Pedestal height shown includes glide.
- Pencil tray and Lock included.
- File Bars are not included with Compile pedestals. To order file bars, use product code CSPEDHFB at \$15.00 each list.

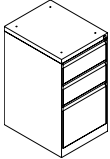
| | DESCRIPTION | PRODUCT CODE | LIST PRICE | DIMENSIONS/INCHES | | |
|---|---|--------------|------------|-------------------|--------|----|
| | | | | H | D | W |
|  | Worksurface Supporting Box/Box/File 15" Pedestal | CS1919BBF | 549 | 27 5/8 | 18 5/8 | 15 |
| | | CS1923BBF | 565 | 27 5/8 | 22 5/8 | 15 |
| | | CS1929BBF | 641 | 27 5/8 | 29 5/8 | 15 |

CS19XXFF - WORKSURFACE SUPPORTING FILE/FILE 15" PEDESTAL

- Worksurface supporting, with predrilled holes in the top.
- Also available as freestanding with finished top.
- All drawer fronts feature a recessed, angled full pull.
- Pedestal height shown includes glide.
- Lock included.
- File Bars are not included with Compile pedestals. To order file bars, use product code CSPEDHFB at \$15.00 each list.

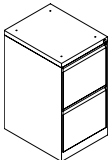
| | DESCRIPTION | PRODUCT CODE | LIST PRICE | DIMENSIONS/INCHES | | |
|---|--|--------------|------------|-------------------|--------|----|
| | | | | H | D | W |
|  | Worksurface Supporting File/File 15" Pedestal | CS1919FF | 549 | 27 5/8 | 18 5/8 | 15 |
| | | CS1923FF | 565 | 27 5/8 | 22 5/8 | 15 |
| | | CS1929FF | 641 | 27 5/8 | 29 5/8 | 15 |

CS19FXXBBF - FREESTANDING BOX/BOX/FILE 15" PEDESTAL

- All drawer fronts feature a recessed, angled full pull.
- Pedestal height shown includes glide.
- Finished top.
- Counterweight, Pencil tray and Lock included.
- File Bars are not included with Compile pedestals. To order file bars, use product code CSPEDHFB at \$15.00 each list.

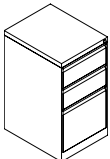
| | DESCRIPTION | PRODUCT CODE | LIST PRICE | DIMENSIONS/INCHES | | |
|---|---|--------------|------------|-------------------|--------|----|
| | | | | H | D | W |
|  | Freestanding Box/Box/File 15" Pedestal | CS19F19BBF | 565 | 27 5/8 | 18 5/8 | 15 |
| | | CS19F23BBF | 582 | 27 5/8 | 22 5/8 | 15 |
| | | CS19F29BBF | 655 | 27 5/8 | 29 5/8 | 15 |

CS19FXXFF - FREESTANDING FILE/FILE 15" PEDESTAL

- All drawer fronts feature a recessed, angled full pull.
- Pedestal height shown includes glide.
- Finished top.
- Counterweight and Lock included.
- File Bars are not included with Compile pedestals. To order file bars, use product code CSPEDHFB at \$15.00 each list.

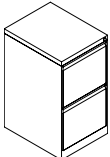
| | DESCRIPTION | PRODUCT CODE | LIST PRICE | DIMENSIONS/INCHES | | |
|---|--|--------------|------------|-------------------|--------|----|
| | | | | H | D | W |
|  | Freestanding File/File 15" Pedestal | CS19F19FF | 565 | 27 5/8 | 18 5/8 | 15 |
| | | CS19F23FF | 582 | 27 5/8 | 22 5/8 | 15 |
| | | CS19F29FF | 655 | 27 5/8 | 29 5/8 | 15 |



CS19MPXXBBF - MOBILE BOX/BOX/FILE PEDESTAL

- All drawer fronts feature a recessed, angled full pull.
- Pedestal height shown includes glide.
- Finished top.
- Counterweight, Pencil tray, and Lock included.
- File Bars are not included with Compile pedestals. To order file bars, use product code CSPEDHFB at \$15.00 each list.

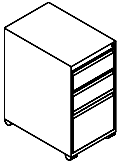
| | DESCRIPTION | PRODUCT CODE | LIST PRICE | DIMENSIONS/INCHES | | |
|---|------------------------------|--------------|------------|-------------------|--------|----|
| | | | | H | D | W |
|  | Mobile Box/Box/File Pedestal | CS19MP19BBF | 748 | 27 7/8 | 18 5/8 | 15 |
| | | CS19MP23BBF | 787 | 27 7/8 | 22 5/8 | 15 |

CS19MPXXFF - MOBILE FILE/FILE PEDESTAL

- All drawer fronts feature a recessed, angled full pull.
- Pedestal height shown includes glide.
- Finished top.
- Counterweight and Lock included.
- File Bars are not included with Compile pedestals. To order file bars, use product code CSPEDHFB at \$15.00 each list.

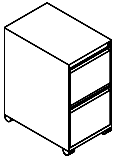
| | DESCRIPTION | PRODUCT CODE | LIST PRICE | DIMENSIONS/INCHES | | |
|---|---------------------------|--------------|------------|-------------------|--------|----|
| | | | | H | D | W |
|  | Mobile File/File Pedestal | CS19MP19FF | 748 | 27 7/8 | 18 5/8 | 15 |
| | | CS19MP23FF | 787 | 27 7/8 | 22 5/8 | 15 |

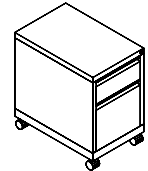

CSMCPXXBFNC - MOBILE BOX/FILE PEDESTAL WITH 60MM CASTERS

- Mobile pedestal that includes one pencil tray.
- Includes factory installed counterweight.
- Lock is standard.
- 60mm high castors.
- For use with pedestal seat cushion. See model below.
- Casters do not lock.

| | DESCRIPTION | PRODUCT CODE | LIST PRICE | DIMENSIONS/INCHES | | |
|---|--|--------------|------------|-------------------|--------|----|
| | | | | H | D | W |
|  | Mobile Box/File Pedestal with 60mm Castors | CSMCP19BFNC | 813 | 23.7/8 | 18.5/8 | 15 |
| | | CSMCP23BFNC | 829 | 23.7/8 | 22.5/8 | 15 |

CSCUSH15 - PEDESTAL SEAT CUSHIONS

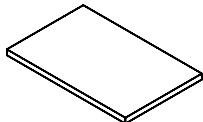
- Cushions will have single stitching at the seams.
- Velcro included for quick attachment to pedestal file.
- 1" Cushion will have a rectilinear design on all sides.
- 2" Cushion will have waterfall edges Front and Back.
- Cushions are for use on CSMCPXXBFNC Mobile Pedestals.
- Please choose a fabric from the standard cushion textiles on pages 94-96

| | DESCRIPTION | PRODUCT CODE | LIST PRICE/GRADES | | | | | | | | | | | | | | | | | DIM./INCH | | | YRDS |
|---|-----------------------------------|-------------------|-------------------|-----|-----|-----|-----|-----|-----|-----|-----|-----|-----|------|------|------|------|------|------|-----------|--------|----|------|
| | | | 1 | 2 | 3 | 4 | 5 | 6 | 7 | 8 | 9 | 10 | 11 | 12 | 13 | 14 | 15 | 16 | 17 | H | D | W | |
|  | Pedestal Seat Cushions - 1" Thick | CSCUSH15X18-5/8X1 | 205 | 238 | 263 | 297 | 348 | 370 | 415 | 489 | 544 | 606 | 733 | 870 | 968 | 1102 | 1367 | 1633 | 1901 | 1 | 18.625 | 15 | 1 |
| | | CSCUSH15X22-5/8X1 | 229 | 262 | 287 | 321 | 372 | 394 | 439 | 513 | 568 | 630 | 757 | 894 | 989 | 1122 | 1389 | 1655 | 1924 | 1 | 22.625 | 15 | 1 |
|  | Pedestal Seat Cushions - 2" Thick | CSCUSH15X18-5/8X2 | 227 | 259 | 283 | 318 | 370 | 392 | 437 | 509 | 565 | 627 | 752 | 892 | 1246 | 1423 | 1777 | 2131 | 2490 | 2 | 18.625 | 15 | 2 |
| | | CSCUSH15X22-5/8X2 | 255 | 288 | 317 | 363 | 426 | 456 | 515 | 608 | 678 | 758 | 923 | 1097 | 1271 | 1449 | 1802 | 2158 | 2514 | 2 | 22.625 | 15 | 2 |

UUPFSBGXXP - PRIME SERIES BOX/BOX/FILE PEDESTAL - WORKSURFACE SUPPORTING

- Two box + one file drawer, locking pedestal.
- Top box drawer 4.8"H; middle box drawer 6.4"H; bottom file drawer 13.6"H (interior 12.5"H) -
- When selected in options, "1" makes the pedestal worksurface supporting, includes pre-drilled top holes for attaching to a worksurface.
- When selected in options, "2" includes a flush top for freestanding applications.
- Worksurface supporting peds can be specified without (NN) or with (W2) a counterweight.
- Freestanding pedestals can be specified without (NN), with concealed casters + counterweight (W1. Add (\$285) or with counterweight only (W2. Add \$240).
- To use as a worksurface supporting pedestal, please specify EVHPB5 separately.
- Pencil tray included top box drawer.
- Ships assembled one carton.

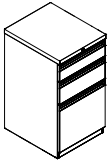
| | DESCRIPTION | PRODUCT CODE | LIST PRICE | DIMENSIONS/INCHES | | |
|---|--|--------------|------------|-------------------|----|----|
| | | | | H | D | W |
|  | Prime Series Box/Box/File Pedestal - Worksurface Supporting | UUPFSBG18P | 720 | 28.2 | 18 | 15 |
| | | UUPFSBG22P | 728 | 28.2 | 22 | 15 |
| | | UUPFSBG28P | 805 | 28.2 | 28 | 15 |

UUPFOFGXXP - PRIME SERIES FILE/FILE PEDESTAL

- Two file drawer, locking pedestal.
- Top file drawer 11.2"H (interior 10.6"H); bottom file drawer 13.6"H (interior 12.5"H).
- When selected in options, "1" makes the pedestal worksurface supporting, includes pre-drilled top holes for attaching to a worksurface.
- When selected in options, "2" includes a flush top for freestanding applications.
- Worksurface supporting peds can be specified without (NN) or with (W2) a counterweight.
- Freestanding pedestals can be specified without (NN), with concealed casters + counterweight (W1. Add \$285) or with counterweight only (W2. Add \$240).
- To use as a worksurface supporting pedestal, please specify EVHPB5 separately.
- Ships assembled one carton.

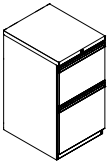
| | DESCRIPTION | PRODUCT CODE | LIST PRICE | DIMENSIONS/INCHES | | |
|---|---|--------------|------------|-------------------|----|----|
| | | | | H | D | W |
|  | Prime Series File/File Pedestal - Worksurface Supporting | UUPFOFG18P | 720 | 28.2 | 18 | 15 |
| | | UUPFOFG22P | 728 | 28.2 | 22 | 15 |
| | | UUPFOFG28P | 805 | 28.2 | 28 | 15 |

UUPF0BFXXP - PRIME SERIES BOX/FILE PEDESTAL

- One box and one file drawer, locking pedestal.
- Freestanding pedestals can be specified without (NN) or with (W2) a counterweight.
- Freestanding pedestals can be specified without (NN), with concealed casters + counterweight (W1. Add \$285) or with counterweight only (W2. Add \$240).
- Pencil tray included in box drawer.
- Ships assembled one carton.

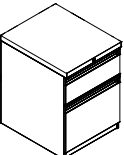
| | DESCRIPTION | PRODUCT CODE | LIST PRICE | DIMENSIONS/INCHES | | |
|---|--------------------------------|--------------|------------|-------------------|----|----|
| | | | | H | D | W |
|  | Prime Series Box/File Pedestal | UUPF0BF18P | 720 | 20.8 | 18 | 15 |
| | | UUPF0BF22P | 728 | 20.8 | 22 | 15 |
| | | UUPF0BF28P | 805 | 20.8 | 28 | 15 |



UUPW0BFXXP - MOBILE BOX/FILE PEDESTAL WITH 60MM CASTERS

- One box and one file drawer; locking mobile pedestal.
- Pencil tray included in box drawer.
- 60mm casters, two locking/two non-locking.
- Ships assembled one carton.

| | DESCRIPTION | PRODUCT CODE | LIST PRICE | DIMENSIONS/INCHES | | |
|---|--|--------------|------------|-------------------|------|----|
| | | | | H | D | W |
|  | Mobile Box/File Pedestal with 60mm Casters | UUPW0BF18P | 871 | 18 | 23.3 | 15 |
| | | UUPW0BF22P | 877 | 22 | 23.3 | 15 |
| | | UUPW0BF28P | 1039 | 28 | 23.3 | 15 |

EVCUSHION15 - PEDESTAL SEAT CUSHIONS

- Cushions will have single stitching at the seams.
- Velcro included for quick attachment to pedestal file.
- 1" Cushion will have a rectilinear design on all sides.
- 2" Cushion will have waterfall edges Front and Back,
- Cushions are for use on Prime Mobile Pedestals.
- Please choose a fabric from the standard cushion textiles offering.

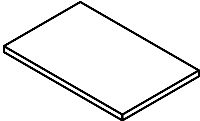
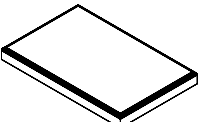
| | DESCRIPTION | PRODUCT CODE | LIST PRICE/GRADES | | | | | | | | | | | | | | | | | DIM./INCH | | | YRDS |
|--|-----------------------------------|------------------|-------------------|-----|-----|-----|-----|-----|-----|-----|-----|-----|------|------|------|------|------|------|------|-----------|----|----|------|
| | | | 1 | 2 | 3 | 4 | 5 | 6 | 7 | 8 | 9 | 10 | 11 | 12 | 13 | 14 | 15 | 16 | 17 | H | D | W | |
|  | Pedestal Seat Cushions - 1" Thick | EVCUSHION15X18X1 | 205 | 241 | 267 | 306 | 361 | 387 | 436 | 516 | 578 | 645 | 785 | 935 | 864 | 981 | 1220 | 1457 | 1692 | 1 | 18 | 15 | 1 |
| | | EVCUSHION15X19X1 | 205 | 241 | 267 | 306 | 361 | 387 | 436 | 516 | 578 | 645 | 785 | 935 | 864 | 981 | 1220 | 1457 | 1692 | 1 | 19 | 15 | 1 |
| | | EVCUSHION15X22X1 | 229 | 266 | 293 | 330 | 387 | 411 | 460 | 542 | 602 | 671 | 809 | 961 | 884 | 1002 | 1241 | 1476 | 1712 | 1 | 22 | 15 | 1 |
| | | EVCUSHION15X23X1 | 229 | 266 | 293 | 330 | 387 | 411 | 460 | 542 | 602 | 671 | 809 | 961 | 884 | 1002 | 1241 | 1476 | 1712 | 1 | 23 | 15 | 1 |
| | | EVCUSHION15X28X1 | 303 | 350 | 380 | 435 | 508 | 543 | 607 | 716 | 797 | 890 | 1076 | 1277 | 1175 | 1332 | 1649 | 1963 | 2279 | 1 | 28 | 15 | 1 |
| | | EVCUSHION15X29X1 | 303 | 350 | 380 | 435 | 508 | 543 | 607 | 716 | 797 | 890 | 1076 | 1277 | 1175 | 1332 | 1649 | 1963 | 2279 | 1 | 29 | 15 | 1 |
|  | Pedestal Seat Cushions - 2" Thick | EVCUSHION15X18X2 | 227 | 263 | 288 | 326 | 381 | 408 | 457 | 538 | 599 | 666 | 804 | 959 | 882 | 1000 | 1236 | 1474 | 1236 | 2 | 18 | 15 | 2 |
| | | EVCUSHION15X19X2 | 227 | 263 | 288 | 326 | 381 | 408 | 457 | 538 | 599 | 666 | 821 | 959 | 882 | 1000 | 1236 | 1474 | 1236 | 2 | 19 | 15 | 2 |
| | | EVCUSHION15X22X2 | 255 | 291 | 317 | 356 | 411 | 437 | 488 | 566 | 628 | 695 | 835 | 985 | 904 | 1023 | 1261 | 1497 | 1734 | 2 | 22 | 15 | 2 |
| | | EVCUSHION15X23X2 | 255 | 291 | 317 | 356 | 411 | 437 | 488 | 566 | 628 | 695 | 835 | 985 | 904 | 1023 | 1261 | 1497 | 1734 | 2 | 23 | 15 | 2 |
| | | EVCUSHION15X28X2 | 338 | 382 | 415 | 468 | 543 | 578 | 642 | 750 | 831 | 924 | 1108 | 1308 | 1204 | 1359 | 1676 | 1990 | 2309 | 2 | 28 | 15 | 2 |
| | | EVCUSHION15X29X2 | 338 | 382 | 415 | 468 | 543 | 578 | 642 | 750 | 831 | 924 | 1108 | 1308 | 1204 | 1359 | 1676 | 1990 | 2309 | 2 | 29 | 15 | 2 |

EVHPB5 - PEDESTAL BRACKET

- Attaches to back edge of a pedestal and connects a pedestal to panel connector.
- Available in standard paint colors.

| | DESCRIPTION | PRODUCT CODE | LIST PRICE | DIMENSIONS/INCHES | |
|---|------------------|--------------|------------|-------------------|--|
| | | | | H | |
|  | Pedestal Bracket | EVHPB5 | 36 | 11 | |

ALL PEDESTALS FEATURE

- Worksurface supporting pedestals are 28”h
- Pencil tray included with B/B/F pedestal
- Box drawer and file drawers mounted on full extension ball bearing slides
- All file drawers come with adjustable rails for legal or letter size hanging folders
- 1-Door pedestal comes handed left or right (handedness is determined by hinge side)
- 1-Door Pedestal includes one adjustable shelf
- Locks are standard on all units and match pull finish

EVL2PBBF - BOX/BOX/FILE WORKSURFACE SUPPORTING PEDESTAL

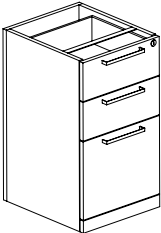
| | DESCRIPTION | PRODUCT CODE | LIST PRICE | DIMENSIONS/INCHES | | |
|---|--|--------------|------------|-------------------|------|----|
| | | | | H | D | W |
|  | Box/Box/File Worksurface Supporting Pedestal | EVL2PBBF18 | 1040 | 28 | 15.5 | 18 |
| | | EVL2PBBF23 | 1150 | 28 | 15.5 | 23 |
| | | EVL2PBBF29 | 1204 | 28 | 15.5 | 29 |

EVL2PFF - FILE/FILE WORKSURFACE SUPPORTING PEDESTAL

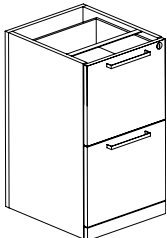
| | DESCRIPTION | PRODUCT CODE | LIST PRICE | DIMENSIONS/INCHES | | |
|--|---|--------------|------------|-------------------|------|----|
| | | | | H | D | W |
|  | File/File Worksurface Supporting Pedestal | EVL2PFF18 | 943 | 28 | 15.5 | 18 |
| | | EVL2PFF23 | 1074 | 28 | 15.5 | 23 |
| | | EVL2PFF29 | 1129 | 28 | 15.5 | 29 |

EVL2P1D - 1-DOOR WORKSURFACE SUPPORTING PEDESTAL

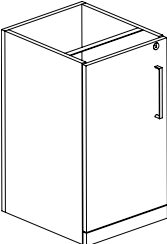
| | DESCRIPTION | PRODUCT CODE | LIST PRICE | DIMENSIONS/INCHES | | |
|---|--|----------------|------------|-------------------|------|----|
| | | | | H | D | W |
|  | 1-Door Worksurface Supporting Pedestal | EVL2P1D18(L/R) | 791 | 28 | 15.5 | 18 |
| | | EVL2P1D23(L/R) | 874 | 28 | 15.5 | 23 |
| | | EVL2P1D29(L/R) | 965 | 28 | 15.5 | 29 |



ALL MOBILE PEDESTALS FEATURE

- Mobile pedestals with inset top are designed for use with cushion
- Pencil tray included with box drawer
- Box drawer and file drawers mounted on full extension ball bearing slides
- If file drawers come with adjustable rails for legal or letter size hanging folders

EVL2PBF - BOX/FILE MOBILE PEDESTAL W/STANDARD TOP

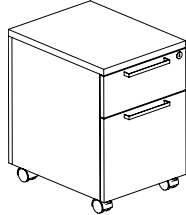

| DESCRIPTION | PRODUCT CODE | LIST PRICE | DIMENSIONS/INCHES | | |
|---|--------------|------------|-------------------|------|----|
| | | | H | D | W |
| Box/File Mobile Pedestal w/Standard Top | EVL2PBF20M | 1327 | 22.69 | 15.5 | 20 |
| | EVL2PBF24M | 1327 | 22.69 | 15.5 | 24 |

EVL2PBF-MIT - BOX/FILE MOBILE PEDESTAL W/INSET TOP

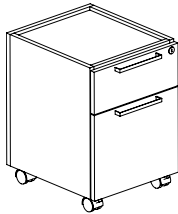

| DESCRIPTION | PRODUCT CODE | LIST PRICE | DIMENSIONS/INCHES | | |
|--------------------------------------|--------------|------------|-------------------|------|----|
| | | | H | D | W |
| Box/File Mobile Pedestal w/Inset Top | EVL2PBF18MIT | 1243 | 22 | 15.5 | 18 |
| | EVL2PBF24MIT | 1318 | 22 | 15.5 | 24 |

EVL PSTC - MOBILE PEDESTAL CUSHION (FOR USE WITH INSET TOP MOBILE PEDESTALS)

| DESCRIPTION | PRODUCT CODE | LIST PRICE/GRADES | | | | | | | | | | | | | | | | | DIM./INCH | | | YRDS |
|-------------------------|--------------|-------------------|-----|-----|-----|-----|-----|-----|-----|-----|-----|-----|-----|------|------|------|------|------|-----------|------|----|------|
| | | 1 | 2 | 3 | 4 | 5 | 6 | 7 | 8 | 9 | 10 | 11 | 12 | 13 | 14 | 15 | 16 | 17 | H | D | W | |
| Mobile Pedestal Cushion | EVL PSTC1518 | 304 | 340 | 358 | 391 | 434 | 454 | 500 | 564 | 617 | 673 | 788 | 912 | 1067 | 1200 | 1456 | 1717 | 1979 | 1 | 15.5 | 18 | 1 |
| | EVL PSTC1524 | 352 | 379 | 405 | 437 | 482 | 502 | 541 | 612 | 663 | 721 | 831 | 959 | 1114 | 1241 | 1503 | 1758 | 2019 | 1 | 15.5 | 24 | 1 |

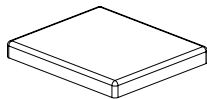

EVSSP12BFM - CUBE STORAGE BF MOBILE PEDESTAL

- Mobile pedestal with door and shelf
- Includes four locking casters
- File interior dimensions: 11 7/8"H x 11 13/16"W x 10 7/16"D
- Metal wire divider file is 3-7/16" from side, can be installed either on the left or right side
- Includes lock
- Shipped KD

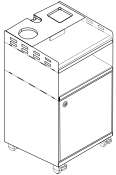
| DESCRIPTION | PRODUCT CODE | LIST PRICE | DIMENSIONS/INCHES | | |
|---|--------------|------------|-------------------|----|----|
| | | | H | D | W |
|  | EVSSP12BFMKL | 819 | 22 | 12 | 12 |
| | EVSSP12BFMKR | 819 | 22 | 12 | 12 |

EVSSP12BBFM - CUBE STORAGE BBF MOBILE PEDESTAL

- Mobile pedestal with door and shelf
- Includes four locking casters
- File interior dimensions: 11 7/8"H x 11 13/16"W x 10 7/16"D
- Metal wire divider in file is 3-7/16" from side, can be installed either on the left or right side
- Includes lock
- Shipped KD

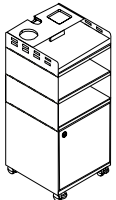
| DESCRIPTION | PRODUCT CODE | LIST PRICE | DIMENSIONS/INCHES | | |
|--|---------------|------------|-------------------|----|----|
| | | | H | D | W |
|  | EVSSP12BBFMKL | 1021 | 28 | 12 | 12 |
| | EVSSP12BBFMKR | 1021 | 28 | 12 | 12 |

EVSSP12SFM - CUBE STORAGE SF MOBILE PEDESTAL

- Mobile pedestal with doors
- Includes four locking casters
- File interior dimensions: 11 7/8"H x 11 13/16"W x 10 7/16"D
- Metal wire divider in storage and file is 3-7/16" from side, can be installed either on the left or right side
- Storage interior dimension: 10 1/2"H x 11 13/16"W x 10 7/16"D
- Includes lock
- Shipped KD

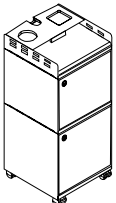
| DESCRIPTION | PRODUCT CODE | LIST PRICE | DIMENSIONS/INCHES | | |
|---|--------------|------------|-------------------|----|----|
| | | | H | D | W |
|  | EVSSP12SFMKL | 1070 | 28 | 12 | 12 |
| | EVSSP12SFMKR | 1070 | 28 | 12 | 12 |



EVSSP12BFM - CUBE STORAGE BF MOBILE PEDESTAL

- Mobile pedestal with door and shelf
 - Includes four locking casters
 - File interior dimensions: 11 7/8"H x 11 13/16"W x 10 7/16"D
 - Metal wire divider in file is 3-7/16" from side, can be installed either on the left or right side
- Shipped KD



| DESCRIPTION | PRODUCT CODE | LIST PRICE | DIMENSIONS/INCHES | | |
|-------------|--------------|------------|-------------------|----|----|
| | | | H | D | W |
| | EVSSP12BFML | 735 | 22 | 12 | 12 |
| | EVSSP12BFMR | 735 | 22 | 12 | 12 |

EVSSP12BBFM - CUBE STORAGE BBF MOBILE PEDESTAL

- Mobile pedestal with door and shelf
 - Includes four locking casters
 - File interior dimensions: 11 7/8"H x 11 13/16"W x 10 7/16"D
 - Metal wire divider in file is 3-7/16" from side, can be installed either on the left or right side
- Shipped KD

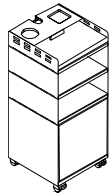

| DESCRIPTION | PRODUCT CODE | LIST PRICE | DIMENSIONS/INCHES | | |
|-------------|--------------|------------|-------------------|----|----|
| | | | H | D | W |
| | EVSSP12BBFML | 938 | 28 | 12 | 12 |
| | EVSSP12BBFMR | 938 | 28 | 12 | 12 |

EVSSP12SFM - CUBE STORAGE SF MOBILE PEDESTAL

- Mobile pedestal with doors
 - Includes four locking casters
 - File interior dimensions: 11 7/8"H x 11 13/16"W x 10 7/16"D
 - Metal wire divider in storage and file is 3-7/16" from side, can be installed either on the left or right side
- Storage interior dimension: 10 1/2"H x 11 13/16"W x 10 7/16"D
 - Shipped KD

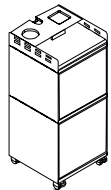

| DESCRIPTION | PRODUCT CODE | LIST PRICE | DIMENSIONS/INCHES | | |
|-------------|--------------|------------|-------------------|----|----|
| | | | H | D | W |
| | EVSSP12SFML | 854 | 28 | 12 | 12 |
| | EVSSP12SFMR | 854 | 28 | 12 | 12 |

EVFELT03BC - PET PIECE FOR SHELF FOR PEDESTAL WITH CLOSED BACK

- PET piece for shelf for pedestal with closed back
- Front edge at 45 degree

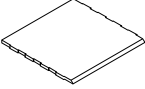
| DESCRIPTION | PRODUCT CODE | LIST PRICE | DIMENSIONS/INCHES | | |
|---|--------------|------------|-------------------|----|------|
| | | | H | D | W |
|  | EVFELT03BC | 42 | 12 | 12 | .038 |

EVSSPH12BF - CUBE STORAGE BF

- Hanging storage
- Attaches to underside of worksurface
- File interior dimensions: 11 7/8"H x 11 13/16"W x 10 7/16"D
- Metal wire divider in file is 3-7/16" from side, can be installed either on the left or right side
- Configuration box/file with door
- Includes lock
- Shipped KD

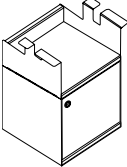
| DESCRIPTION | PRODUCT CODE | LIST PRICE | DIMENSIONS/INCHES | | |
|---|--------------|------------|-------------------|----|----|
| | | | H | D | W |
|  | EVSSPH12BFKL | 610 | 18.5 | 12 | 12 |
| | EVSSPH12BFKR | 610 | 18.5 | 12 | 12 |

EVSSPH12BFB - CUBE STORAGE BFB

- Hanging storage
- Attaches to underside of worksurface
- File interior dimensions: 11 7/8"H x 11 13/16"W x 10 7/16"D
- Metal wire divider in file is 3-7/16" from side, can be installed either on the left or right side
- Configuration box/file with door/box
- Includes lock
- Shipped KD

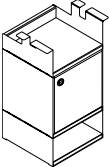
| DESCRIPTION | PRODUCT CODE | LIST PRICE | DIMENSIONS/INCHES | | |
|---|---------------|------------|-------------------|----|----|
| | | | H | D | W |
|  | EVSSPH12BFBKL | 812 | 24 | 12 | 12 |
| | EVSSPH12BFBKR | 812 | 24 | 12 | 12 |



EVSSPH12BF - CUBE STORAGE BF

- Hanging storage
- Attaches to underside of worksurface
- File interior dimensions: 11 7/8"H x 11 13/16"W x 10 7/16"D
- Metal wire divider in file is 3-7/16" from side, can be installed either on the left or right side
- Configuration box/file with door
- Shipped KD

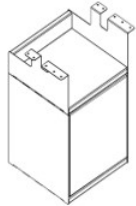

| DESCRIPTION | PRODUCT CODE | LIST PRICE | DIMENSIONS/INCHES | | |
|-------------|--------------|------------|-------------------|----|----|
| | | | H | D | W |
| | EVSSPH12BFL | 526 | 18.5 | 12 | 12 |
| | EVSSPH12BFR | 526 | 18.5 | 12 | 12 |

EVSSPH12BFB - CUBE STORAGE BFB

- Hanging storage
- Attaches to underside of worksurface
- File interior dimensions: 11 7/8"H x 11 13/16"W x 10 7/16"D
- Metal wire divider in file is 3-7/16" from side, can be installed either on the left or right side
- Configuration box/file with door/box
- Shipped KD

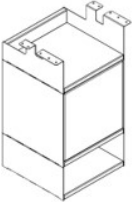

| DESCRIPTION | PRODUCT CODE | LIST PRICE | DIMENSIONS/INCHES | | |
|-------------|--------------|------------|-------------------|----|----|
| | | | H | D | W |
| | EVSSPH12BFBL | 729 | 24 | 12 | 12 |
| | EVSSPH12BFBR | 729 | 24 | 12 | 12 |

EVSSPH12B - CUBE STORAGE B

- Hanging storage
- Attaches to underside of worksurface
- Configuration box
- Shipped KD

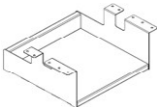

| DESCRIPTION | PRODUCT CODE | LIST PRICE | DIMENSIONS/INCHES | | |
|-------------|--------------|------------|-------------------|----|----|
| | | | H | D | W |
| | EVSSPH12B | 204 | 11.5 | 12 | 12 |

EVSSPH12BB - CUBE STORAGE BB

- Hanging storage
- Attaches to underside of worksurface
- Configuration box/box
- Shipped KD

| DESCRIPTION | PRODUCT CODE | LIST PRICE | DIMENSIONS/INCHES | | |
|-------------|--------------|------------|-------------------|----|----|
| | | | H | D | W |
| | EVSSPH12BB | 406 | 17 | 12 | 12 |

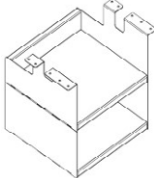

CS19XX-1X1FH - ONE 1/2 HEIGHT FIXED FRONT & ONE 12" FIXED FRONT LATERAL FILE

- 1/2 Height Box Drawer.
- 1 Fixed Drawer Front.
- Includes Lock.
- Lateral File Top is required when not installed under a worksurface.
- Counterweights must be specified on lateral files with pull out drawers, unless worksurface supporting, ganged together or anchored to the floor or wall.

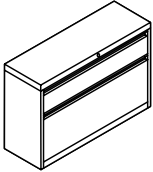
| | DESCRIPTION | PRODUCT CODE | LIST PRICE | DIMENSIONS/INCHES | | |
|---|----------------------------------|---------------|------------|-------------------|-------|----|
| | | | | H | D | W |
|  | One 1/2 Height Fixed Front & | CS1930P-1X1FH | 1241 | 21.1875 | 19.25 | 30 |
| | One 12" Fixed Front Lateral File | CS1936P-1X1FH | 1325 | 21.1875 | 19.25 | 36 |
| | | CS1942P-1X1FH | 1407 | 21.1875 | 19.25 | 42 |

CS19XX-1XSND - ONE 1/2 HEIGHT OPEN SHELF & ONE 12" OPEN SHELF LATERAL CABINET

- 1/2 Height Open Shelf.
- Bottom Open Shelf.

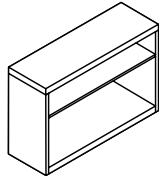
| | DESCRIPTION | PRODUCT CODE | LIST PRICE | DIMENSIONS/INCHES | | |
|--|------------------------------------|--------------|------------|-------------------|-------|----|
| | | | | H | D | W |
|  | One 1/2 Height Open Shelf & | CS1930-1XSND | 622 | 21.1875 | 19.25 | 30 |
| | One 12" Open Shelf Lateral Cabinet | CS1936-1XSND | 707 | 21.1875 | 19.25 | 36 |
| | | CS1942-1XSND | 787 | 21.1875 | 19.25 | 42 |

CSCUSH19 - LATERAL SEAT CUSHIONS

- Cushions will have single stitching at the seams,
- Velcro included for quick attachment to lateral file.
- 1" Cushion will have a rectilinear design on all sides.
- 2" Cushion will have waterfall edges Front and Back.
- Please choose a fabric from the standard cushion textiles offering.

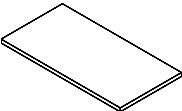
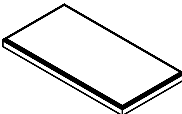
| | DESCRIPTION | PRODUCT CODE | LIST PRICE/GRADES | | | | | | | | | | | | | | | DIM./INCH | | | YRDS | | |
|---|---------------------|------------------|-------------------|-----|-----|-----|-----|-----|-----|-----|-----|-----|------|------|------|------|------|-----------|------|---|------|----|---|
| | | | 1 | 2 | 3 | 4 | 5 | 6 | 7 | 8 | 9 | 10 | 11 | 12 | 13 | 14 | 15 | 16 | 17 | H | | D | W |
|  | Lateral Seat | CSCUSH19-25X30X1 | 374 | 416 | 448 | 494 | 564 | 595 | 658 | 755 | 830 | 914 | 1086 | 1268 | 1417 | 1597 | 1951 | 2306 | 2661 | 1 | 19 | 30 | 1 |
| | Cushions - 1" Thick | CSCUSH19-25X36X1 | 388 | 430 | 462 | 510 | 578 | 609 | 672 | 769 | 844 | 928 | 1100 | 1281 | 1428 | 1606 | 1962 | 2317 | 2675 | 1 | 19 | 36 | 1 |
| | | CSCUSH19-25X42X1 | 402 | 443 | 476 | 522 | 591 | 622 | 684 | 780 | 856 | 941 | 1112 | 1295 | 1369 | 1547 | 1902 | 2257 | 2613 | 1 | 19 | 42 | 1 |
|  | Lateral Seat | CSCUSH19-25X30X2 | 415 | 457 | 489 | 535 | 605 | 636 | 697 | 793 | 869 | 954 | 1125 | 1308 | 1380 | 1558 | 1914 | 2268 | 2626 | 2 | 19 | 30 | 2 |
| | Cushions - 2" Thick | CSCUSH19-25X36X2 | 426 | 468 | 500 | 546 | 615 | 647 | 708 | 804 | 880 | 965 | 1136 | 1319 | 1391 | 1568 | 1924 | 2277 | 2634 | 2 | 19 | 36 | 2 |
| | | CSCUSH19-25X42X2 | 442 | 484 | 516 | 564 | 632 | 663 | 724 | 823 | 896 | 981 | 1152 | 1335 | 1401 | 1580 | 1933 | 2290 | 2645 | 2 | 18 | 42 | 2 |

UULPS0F18XXP - ONE 1/2 HEIGHT FIXED FRONT & ONE 12" FIXED FRONT LATERAL FILE

- Fixed front drawers, top box drawer front 6.4"H (interior 5.2"H) bottom file drawer front 11.2"H (interior 10.8"H).
- Locking.
- Side to side hanging bars included.
- Ships assembled one carton

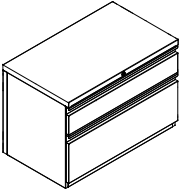
| | DESCRIPTION | PRODUCT CODE | LIST PRICE | DIMENSIONS/INCHES | | |
|---|----------------------------------|---------------|------------|-------------------|----|----|
| | | | | H | D | W |
|  | One 1/2 Height Fixed Front & | UULPS0BF1830P | 1679 | 21 | 18 | 30 |
| | One 12" Fixed Front Lateral File | UULPS0BF1836P | 1748 | 21 | 18 | 36 |
| | | UULPS0BF1842P | 1808 | 21 | 18 | 42 |

EVCUSHION18 - LATERAL SEAT CUSHIONS

- Cushions will have single stitching at the seams.
- Velcro included for quick attachment to lateral file.
- 1" Cushion will have a rectilinear design on all sides.
- 2" Cushion will have waterfall edges Front and Back.
- Please choose a fabric from the standard cushion textile offering.

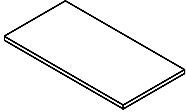
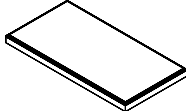
| | DESCRIPTION | PRODUCT CODE | LIST PRICE/GRADES | | | | | | | | | | | | | | DIM./INCH | | | YRDS | | | |
|--|---------------------|------------------|-------------------|-----|-----|-----|-----|-----|-----|-----|-----|-----|------|------|------|------|-----------|------|------|------|----|----|---|
| | | | 1 | 2 | 3 | 4 | 5 | 6 | 7 | 8 | 9 | 10 | 11 | 12 | 13 | 14 | 15 | 16 | 17 | | H | D | W |
|  | Lateral Seat | EVCUSHION18X30X1 | 318 | 365 | 398 | 449 | 523 | 557 | 624 | 731 | 813 | 752 | 1091 | 1290 | 1186 | 1346 | 1659 | 1976 | 2292 | 1 | 18 | 30 | 1 |
| | Cushions - 1" Thick | EVCUSHION18X36X1 | 354 | 401 | 436 | 486 | 561 | 595 | 662 | 768 | 848 | 941 | 1127 | 1328 | 1528 | 1727 | 2127 | 2528 | 2925 | 1 | 18 | 36 | 1 |
| | | EVCUSHION18X42X1 | 378 | 425 | 459 | 510 | 585 | 618 | 686 | 792 | 873 | 966 | 1152 | 1354 | 1236 | 1396 | 1711 | 2026 | 2341 | 1 | 18 | 42 | 1 |
|  | Lateral Seat | EVCUSHION18X30X2 | 1322 | 396 | 427 | 480 | 555 | 590 | 654 | 762 | 844 | 936 | 1123 | 1322 | 1214 | 1370 | 1686 | 2002 | 2316 | 2 | 18 | 30 | 2 |
| | Cushions - 2" Thick | EVCUSHION18X36X2 | 392 | 439 | 472 | 522 | 598 | 632 | 698 | 804 | 885 | 979 | 1166 | 1364 | 1564 | 1765 | 2163 | 2564 | 2964 | 2 | 18 | 36 | 2 |
| | | EVCUSHION18X42X2 | 392 | 439 | 472 | 522 | 598 | 632 | 698 | 804 | 885 | 979 | 1166 | 1364 | 1267 | 1424 | 1740 | 2057 | 2371 | 2 | 18 | 42 | 2 |

EVT - LATERAL FILE TOPS

- Note the following abbreviations:
T = Thermally-Fused Laminate and H = High Pressure Laminate.
- Available in standard Evolve finishes.

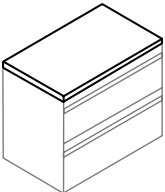
| | DESCRIPTION | PRODUCT CODE | LIST PRICE | | DIMENSIONS/INCHES | | |
|---|-------------------|--------------|------------|--------|-------------------|----|-----|
| | | | LP | HP ADD | H | D | W |
|  | Lateral File Tops | EVT1830 | 163 | 66 | 1 | 18 | 30 |
| | | EVT1836 | 185 | 77 | 1 | 18 | 36 |
| | | EVT1842 | 223 | 120 | 1 | 18 | 42 |
| | | EVT1860 | 301 | 218 | 1 | 18 | 60 |
| | | EVT1872 | 355 | 230 | 1 | 18 | 72 |
| | | EVT1884 | 495 | 171 | 1 | 18 | 84 |
| | | EVT1890 | 534 | 192 | 1 | 18 | 90 |
| | | EVT18108 | 645 | 249 | 1 | 18 | 108 |



CS19XXP - 2F12 - LATERAL FILES - 2 DRAWERS WITH COUNTERWEIGHT

- Counterweight is standard. Two fixed front drawers.
- Side-to-side hanging file bars included.
- Drawers are 12.25" high.
- File cannot be used to store standard three ring binders.
- Lock included.



| DESCRIPTION | PRODUCT CODE | LIST PRICE | DIMENSIONS/INCHES | | |
|--|--------------|------------|-------------------|-------|----|
| | | | H | D | W |
| Lateral Files - 2 Drawers with Counterweight | CS1930P-2F12 | 985 | 27.14 | 19.25 | 30 |
| | CS1936P-2F12 | 1061 | 27.14 | 19.25 | 36 |
| | CS1942P-2F12 | 1103 | 27.14 | 19.25 | 42 |

CS19XXP - 3F12 - LATERAL FILES - 3 DRAWERS WITH COUNTERWEIGHT

- Counterweight is standard. Three fixed front drawers.
- Side-to-side hanging file bars included.
- Drawers are 12.25" high.
- File cannot be used to store standard three ring binders.
- Lock included.



| DESCRIPTION | PRODUCT CODE | LIST PRICE | DIMENSIONS/INCHES | | |
|--|--------------|------------|-------------------|-------|----|
| | | | H | D | W |
| Lateral Files - 3 Drawers with Counterweight | CS1930P-3F12 | 1226 | 39.52 | 19.25 | 30 |
| | CS1936P-3F12 | 1292 | 39.52 | 19.25 | 36 |
| | CS1942P-3F12 | 1349 | 39.52 | 19.25 | 42 |

CS19XXP - 4F12 - LATERAL FILES - 4 DRAWERS WITH COUNTERWEIGHT

- Counterweight is standard. Four fixed front drawers.
- Side-to-side hanging file bars included.
- Drawers are 12.25" high.
- File cannot be used to store standard three ring binders.
- Posting shelf option NOT available.
- Lock included.

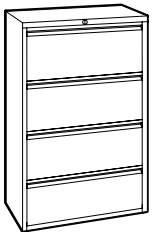

| DESCRIPTION | PRODUCT CODE | LIST PRICE | DIMENSIONS/INCHES | | |
|--|--------------|------------|-------------------|-------|----|
| | | | H | D | W |
| Lateral Files - 4 Drawers with Counterweight | CS1930P-4F12 | 1565 | 51.89 | 19.25 | 30 |
| | CS1936P-4F12 | 1639 | 51.89 | 19.25 | 36 |
| | CS1942P-4F12 | 1764 | 51.89 | 19.25 | 42 |

CS19XXP - 5F12 - LATERAL FILES - 5 DRAWERS

- Four fixed front drawers plus top drawer with receding door and roll-out shelf.
- Side-to-side hanging file bars included.
- Drawers are 12.25" high.
- File cannot be used to store standard three ring binders.
- Posting shelf option NOT available.
- Lock included.

| DESCRIPTION | PRODUCT CODE | LIST PRICE | DIMENSIONS/INCHES | | |
|---------------------------|--------------|------------|-------------------|-------|----|
| | | | H | D | W |
| Lateral Files - 5 Drawers | CS1930P-5F12 | 1863 | 66.39 | 19.25 | 30 |
| | CS1936P-5F12 | 1945 | 66.39 | 19.25 | 36 |
| | CS1942P-5F12 | 2052 | 66.39 | 19.25 | 42 |

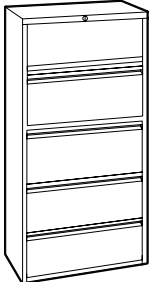

UULF18P - 12" OPENING LATERAL FILE FIXED FRONT DRAWERS

- Fixed front file drawers, top drawer front 11.2"H (interior 10.6"H) bottom drawer front 13.6"H (interior 12.5"H).
- Locking.
- Side to side hanging bars included.
- Ships assembled one carton
- Counterweight (W2) available. Upcharge applies.
- Individually locking drawers (KID) available. Upcharge applies.

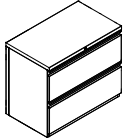
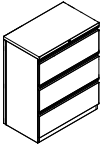
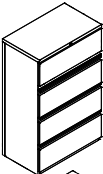
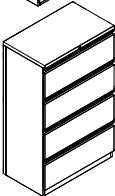
| | DESCRIPTION | PRODUCT CODE | LIST PRICE | DIMENSIONS/INCHES | | |
|--|---|--------------|------------|-------------------|----|----|
| | | | | H | D | W |
|  | Lateral File - 2 High | UULF20G1830P | 1430 | 28 | 18 | 30 |
| | | UULF20G1836P | 1495 | 28 | 18 | 36 |
| | | UULF20G1842P | 1578 | 28 | 18 | 42 |
| | Add \$464 for counterweight (W2). Add \$381 for individually locking drawers (KID) | | | | | |
|  | Lateral File - 3 High | UULF30G1830P | 1874 | 39.2 | 18 | 30 |
| | | UULF30G1836P | 1969 | 39.2 | 18 | 36 |
| | | UULF30G1842P | 2084 | 39.2 | 18 | 42 |
| | Add \$448 for counterweight (W2). Add \$768 for individually locking drawers (KID) | | | | | |
|  | Lateral File - 4 High | UULF40H1830P | 2379 | 53.6 | 18 | 30 |
| | | UULF40H1836P | 2503 | 53.6 | 18 | 36 |
| | | UULF40H1842P | 2653 | 53.6 | 18 | 42 |
| | Add \$272 for counterweight (W2). Add \$1148 for individually locking drawers (KID) | | | | | |
|  | Lateral File - 5 High | UULF50P1830P | 2941 | 65.6 | 18 | 30 |
| | | UULF50P1836P | 3064 | 65.6 | 18 | 36 |
| | | UULF50P1842P | 3229 | 65.6 | 18 | 42 |
| | Add \$272 for counterweight (W2). Add \$1535 for individually locking drawers (KID) | | | | | |

EVT - LATERAL FILE TOPS

- Note the following abbreviations:
- T = Thermally-Fused Laminate
- H = High Pressure Laminate
- Available in standard Evolve finishes.

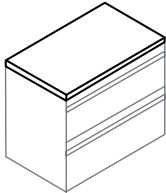
| DESCRIPTION | PRODUCT CODE | LIST PRICE | | DIMENSIONS/INCHES | | |
|---|--------------|------------|-----|-------------------|----|-----|
| | | LP | HP | H | D | W |
|  Lateral File Tops | EVT1830 | 163 | 66 | 1 | 18 | 30 |
| | EVT1836 | 185 | 77 | 1 | 18 | 36 |
| | EVT1842 | 223 | 120 | 1 | 18 | 42 |
| | EVT1860 | 301 | 218 | 1 | 18 | 60 |
| | EVT1872 | 355 | 230 | 1 | 18 | 72 |
| | EVT1884 | 495 | 171 | 1 | 18 | 84 |
| | EVT1890 | 534 | 192 | 1 | 18 | 90 |
| | EVT18108 | 645 | 249 | 1 | 18 | 108 |

LATERAL FILES FEATURES

- Worksurface supporting lateral files ship without a top
- All lateral files feature drawer interlocking system
- All file drawers come with adjustable rails for legal or letter size hanging folders
- "C" combo lateral includes a pencil tray with one box drawer.
- "C" combo lateral only locks on one side
- Lateral files with doors include one adjustable shelf
- Locks are standard on all units and match pull finish
- File drawers are mounted on full extension ball bearing slides

EVL2L2H - FILE/FILE WORKSURFACE SUPPORTING LATERAL FILE, 18"D & 22"D

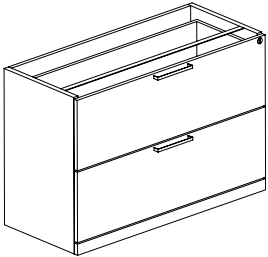
| | DESCRIPTION | PRODUCT CODE | LIST PRICE | DIMENSIONS/INCHES | | |
|---|---|--------------|------------|-------------------|----|----|
| | | | | H | D | W |
|  | File/File Worksurface Supporting Pedestal | EVL2L2H1830 | 1690 | 28 | 30 | 18 |
| | | EVL2L2H1836 | 1800 | 28 | 36 | 18 |
| | | EVL2L2H1842 | 1870 | 28 | 42 | 18 |
| | | EVL2L2H2230 | 1740 | 28 | 30 | 22 |
| | | EVL2L2H2236 | 1850 | 28 | 36 | 22 |
| | | EVL2L2H2242 | 1979 | 28 | 42 | 22 |

EVL2L2D - 2-DOOR WORKSURFACE SUPPORTING LATERAL FILE, 18"D & 22"D

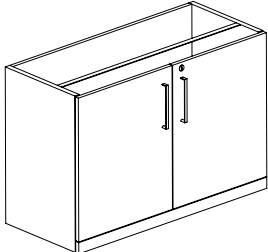
| | DESCRIPTION | PRODUCT CODE | LIST PRICE | DIMENSIONS/INCHES | | |
|---|--|--------------|------------|-------------------|----|----|
| | | | | H | D | W |
|  | 2-Door Worksurface Supporting Lateral File | EVL2L2D1830 | 1183 | 28 | 30 | 18 |
| | | EVL2L2D1836 | 1243 | 28 | 36 | 18 |
| | | EVL2L2D1842 | 1368 | 28 | 42 | 18 |
| | | EVL2L2D2230 | 1280 | 28 | 30 | 22 |
| | | EVL2L2D2236 | 1314 | 28 | 36 | 22 |
| | | EVL2L2D2242 | 1513 | 28 | 42 | 22 |

COMBO LATERAL FILES FEATURES

- Worksurface supporting lateral files ship without a top
- All lateral files feature drawer interlocking system
- All file drawers come with adjustable rails for legal or letter size hanging folders
- "C" combo lateral includes a pencil tray with one box drawer.
- "C" combo lateral only locks on one side
- Locks are standard on all units and match pull finish
- File drawers are mounted on full extension ball bearing slides

EVL2LCR - RIGHT-HAND WORKSURFACE SUPPORTING COMBO LATERAL FILE, 18"D & 22"D

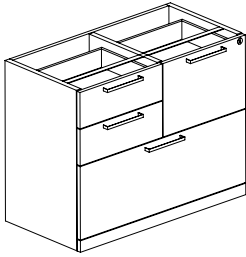
| | DESCRIPTION | PRODUCT CODE | LIST PRICE | DIMENSIONS/INCHES | | |
|---|--|--------------|------------|-------------------|----|----|
| | | | | H | D | W |
|  | Right-Hand Worksurface Supporting Combo Lateral File | EVL2LCR1830 | 2075 | 28 | 30 | 18 |
| | | EVL2LCR1836 | 2418 | 28 | 36 | 18 |
| | | EVL2LCR2230 | 2409 | 28 | 30 | 22 |
| | | EVL2LCR2236 | 2534 | 28 | 36 | 22 |

EVL2LCL - LEFT-HAND WORKSURFACE SUPPORTING COMBO LATERAL FILE, 18"D & 22"D

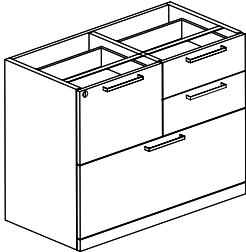
| | DESCRIPTION | PRODUCT CODE | LIST PRICE | DIMENSIONS/INCHES | | |
|--|--|--------------|------------|-------------------|----|----|
| | | | | H | D | W |
|  | 2-Door Worksurface Supporting Lateral File | EVL2LCL1830 | 2075 | 28 | 30 | 18 |
| | | EVL2LCL1836 | 2418 | 28 | 36 | 18 |
| | | EVL2LCL2230 | 2409 | 28 | 30 | 22 |
| | | EVL2LCL2236 | 2534 | 28 | 36 | 22 |



UCCP - 12" OPENING MULTI STORAGE UNIT

- 2 lateral file drawers and storage with hinged doors.
- 2 Locks per unit is included, (1) for door (1) for drawers.
- Open shelving with one fixed and two adjustable shelves, Two lateral file drawers.
- Side-to-side hanging file bars included. Locking and full pull handle design.
- Counterweight (W2) available. Upcharge applies.
- Individually locking drawers (KID) available. Upcharge applies.

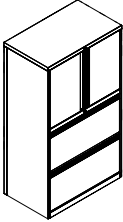
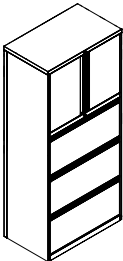
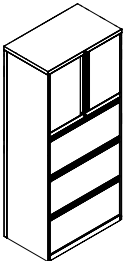
| | DESCRIPTION | PRODUCT CODE | LIST PRICE | DIMENSIONS/INCHES | | |
|--|---|--------------|------------|-------------------|----|----|
| | | | | H | D | W |
|  | 12" Opening Multi Storage Unit - 4 High (50" High) | UUCC41G1830P | 3002 | 49.6 | 18 | 30 |
| | | UUCC41G1836P | 3214 | 49.6 | 18 | 36 |
| | | UUCC41G1842P | 3459 | 49.6 | 18 | 42 |
| Add \$272 for counterweight (W2). Add \$381 for individually locking drawers (KID) | | | | | | |
|  | 12" Opening Multi Storage Unit - 4 High (54" High) | UUCC41H1830P | 3151 | 53.6 | 18 | 30 |
| | | UUCC41H1836P | 3370 | 53.6 | 18 | 36 |
| | | UUCC41H1842P | 3496 | 53.6 | 18 | 42 |
| Add \$272 for counterweight (W2). Add \$381 for individually locking drawers (KID) | | | | | | |
|  | 12" Opening Multi Storage Unit - 5 High (3 Lateral) | UUCC51C1830P | 3504 | 65.6 | 18 | 30 |
| | | UUCC51C1836P | 3767 | 65.6 | 18 | 36 |
| | | UUCC51C1842P | 4063 | 65.6 | 18 | 42 |
| Add \$272 for counterweight (W2). Add \$768 for individually locking drawers (KID) | | | | | | |

UUSC - 12" STORAGE CABINET WITH HINGED DOOR

- SC2 - 28" high with 1 shelf.
- SC3 - 39.2" high with 2 shelves.
- SC4 - 53.6" high with 3 shelves.
- SC5 - 65.6" high with 4 shelves.
- Shelves are height adjustable.
- Lock is included.

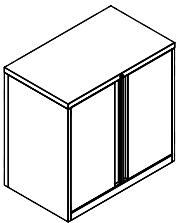
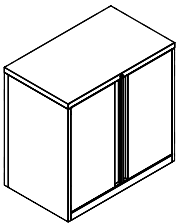
| | DESCRIPTION | PRODUCT CODE | LIST PRICE | DIMENSIONS/INCHES | | |
|---|---|--------------|------------|-------------------|----|----|
| | | | | H | D | W |
|  | 12" Storage Cabinet with Hinged Door - 2 High (WS Supporting) | UUSC21G1830P | 1174 | 28 | 18 | 30 |
| | | UUSC21G1836P | 1307 | 28 | 18 | 36 |
| | | UUSC21G1842P | 1424 | 28 | 18 | 42 |
|  | 12" Storage Cabinet with Hinged Door - 3 High | UUSC31G1830P | 1449 | 39.2 | 18 | 30 |
| | | UUSC31G1836P | 1643 | 39.2 | 18 | 36 |
| | | UUSC31G1842P | 1817 | 39.2 | 18 | 42 |
|  | 12" Storage Cabinet with Hinged Door - 4 High | UUSC41H1830P | 1749 | 53.6 | 18 | 30 |
| | | UUSC41H1836P | 1953 | 53.6 | 18 | 36 |
| | | UUSC41H1842P | 2162 | 53.6 | 18 | 42 |
|  | 12" Storage Cabinet with Hinged Door - 5 High | UUSC51C1830P | 1973 | 65.6 | 18 | 30 |
| | | UUSC51C1836P | 2213 | 65.6 | 18 | 36 |
| | | UUSC51C1842P | 2450 | 65.6 | 18 | 42 |

FRONT TO BACK FILE BAS

- Includes two bars
- Finish in eco-grey.

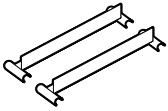
| | DESCRIPTION | PRODUCT CODE | LIST PRICE | DIMENSIONS/INCHES | | |
|---|-----------------|--------------|------------|-------------------|------|---|
| | | | | H | D | W |
|  | Cross File Bars | UULFA0718 | 31 | 1 | 17.3 | 1 |

HANGING FILE BARS

- One pair. Grey.
- For 30", 36" or 42" widths.
- Included in standard product.

| | DESCRIPTION | PRODUCT CODE | LIST PRICE | DIMENSIONS/INCHES | | |
|---|-------------------|--------------|------------|-------------------|----|-----|
| | | | | H | D | W |
|  | Hanging File Bars | UULFA01 | 59 | 275 | .5 | 1.3 |
| | Pair | UULFA02 | 59 | 33.5 | .5 | 1.3 |
| | | UULFA03 | 59 | 39.5 | .5 | 1.3 |

PLATE DIVIDERS

- Three per package.
- For use with Prime series lateral files.

| | DESCRIPTION | PRODUCT CODE | LIST PRICE | DIMENSIONS/INCHES | | |
|---|---------------------|--------------|------------|-------------------|----|-------|
| | | | | H | D | W |
|  | Plate Dividers, 18D | UULFA1018 | 62 | 7.25 | .2 | 13.25 |

HALF HEIGHT DIVIDER PLATES

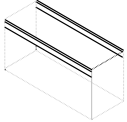
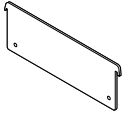
- Three per package.
- For use with Prime series lateral files.

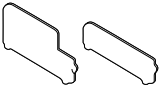
| | DESCRIPTION | PRODUCT CODE | LIST PRICE | DIMENSIONS/INCHES | | |
|---|---------------------------------|--------------|------------|-------------------|----|------|
| | | | | H | D | W |
|  | Half Height divider plates, 18D | UULFA2418 | 62 | 3.95 | .5 | 13.5 |

EDP ADAPTER

- One pair. Grey.
- Extends side height of lateral file drawers by 1"

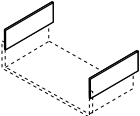
| | DESCRIPTION | PRODUCT CODE | LIST PRICE | DIMENSIONS/INCHES | | |
|---|--------------|--------------|------------|-------------------|-----|------|
| | | | | H | D | W |
|  | EDP adapters | UULFA2018 | 60 | 2.65 | .15 | 16.5 |



ADDITIONAL KEY

- For Prime series files.

| | DESCRIPTION | PRODUCT CODE | LIST PRICE | DIMENSIONS/INCHES | | |
|---|----------------|--------------|------------|-------------------|---|---|
| | | | | H | D | W |
|  | Additional Key | UUKY | 17 | | | |

REPLACEMENT LOCK AND LEY

- For Prime series files.

| | DESCRIPTION | PRODUCT CODE | LIST PRICE | DIMENSIONS/INCHES | | |
|--|--------------|--------------|------------|-------------------|---|---|
| | | | | H | D | W |
| | Lock and Key | UUKC | 51 | | | |

EXTRA CABINET SHELF, NON SLOTTED

- For Prime series files.

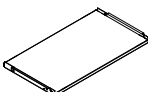
| | DESCRIPTION | PRODUCT CODE | LIST PRICE | DIMENSIONS/INCHES | | |
|---|-----------------------------|--------------|------------|-------------------|----|------|
| | | | | H | D | W |
|  | Cabinet Shelf - Non Slotted | UUSA11830 | 406 | .8 | 16 | 28.4 |
| | | UUSA11836 | 456 | .8 | 16 | 34.4 |
| | | UUSA11842 | 478 | .8 | 16 | 40.4 |

EXTRA CABINET SHELF, SLOTTED

- For Prime series files.

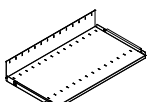
| | DESCRIPTION | PRODUCT CODE | LIST PRICE | DIMENSIONS/INCHES | | |
|---|-------------------------|--------------|------------|-------------------|----|------|
| | | | | H | D | W |
|  | Cabinet Shelf - Slotted | UUSA21830 | 478 | 5.25 | 16 | 28.4 |
| | | UUSA21836 | 556 | 5.25 | 16 | 34.4 |
| | | UUSA21842 | 589 | 5.25 | 16 | 40.4 |

STORAGE TOWERS W/CUPBOARD

- Storage tower with cupboard above FF or BBF and wardrobes will lock only the wardrobe and drawers
- Storage towers with wardrobe include a coat rod
- Locks are standard on all units and match pull finish

EVL2TWBBF2DL - STORAGE TOWER W/CUPBOARD, BOX/BOX/FILE, RIGHT & LEFT HAND

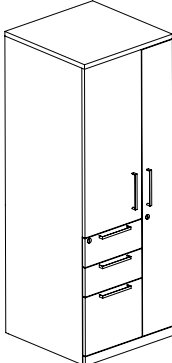
| | DESCRIPTION | PRODUCT CODE | LIST PRICE | DIMENSIONS/INCHES | | | | |
|---|---|------------------|------------------|-------------------|----|----|----|--|
| | | | | H | D | W | | |
|  <p>Right Hand Shown</p> | Storage Tower w/Cupboard, Box/Box/File, | EVL2TWBBF2DL4224 | 2590 | 42 | 24 | 24 | | |
| | | EVL2TWBBF2DL4824 | 2590 | 48 | 24 | 24 | | |
| | | EVL2TWBBF2DL5424 | 2679 | 54 | 24 | 24 | | |
| | | EVL2TWBBF2DL6624 | 3002 | 66 | 24 | 24 | | |
| | | | EVL2TWBBF2DR4224 | 2590 | 42 | 24 | 24 | |
| | | | EVL2TWBBF2DR4824 | 2590 | 48 | 24 | 24 | |
| | | | EVL2TWBBF2DR5424 | 2679 | 54 | 24 | 24 | |
| | | | EVL2TWBBF2DR6624 | 3002 | 66 | 24 | 24 | |
| | | | | | | | | |
| | | | | | | | | |

EVL2TW2F2DL - STORAGE TOWER W/CUPBOARD, FILE/FILE, RIGHT & LEFT HAND

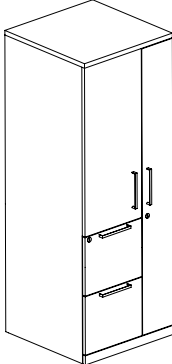
| | DESCRIPTION | PRODUCT CODE | LIST PRICE | DIMENSIONS/INCHES | | | | |
|---|-------------------------------------|-----------------|-----------------|-------------------|----|----|----|--|
| | | | | H | D | W | | |
|  <p>Right Hand Shown</p> | Storage Tower w/Cupboard, File/File | EVL2TW2F2DL4224 | 2493 | 42 | 24 | 24 | | |
| | | EVL2TW2F2DL4824 | 2493 | 48 | 24 | 24 | | |
| | | EVL2TW2F2DL5424 | 2561 | 54 | 24 | 24 | | |
| | | EVL2TW2F2DL6624 | 2871 | 66 | 24 | 24 | | |
| | | | EVL2TW2F2DR4224 | 2493 | 42 | 24 | 24 | |
| | | | EVL2TW2F2DR4824 | 2493 | 48 | 24 | 24 | |
| | | | EVL2TW2F2DR5424 | 2561 | 54 | 24 | 24 | |
| | | | EVL2TW2F2DR6624 | 2871 | 66 | 24 | 24 | |
| | | | | | | | | |
| | | | | | | | | |



STORAGE TOWERS W/SIDE ACCESS

- Storage tower with cupboard above FF or BBF and wardrobes will lock only the wardrobe and drawers
- Storage towers with wardrobe include a coat rod
- Locks are standard on all units and match pull finish

EVL2TWBBFDOL - STORAGE TOWER W/SIDE ACCESS, BOX/BOX/FILE, RIGHT & LEFT HAND

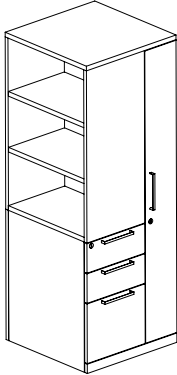
| | DESCRIPTION | PRODUCT CODE | LIST PRICE | DIMENSIONS/INCHES | | | |
|---|--|------------------|------------------|-------------------|----|----|----|
| | | | | H | D | W | |
|  <p>Right Hand Shown</p> | Storage Tower w/Side Access, Box/Box/File, | EVL2TWBBFDOL4224 | 2384 | 42 | 24 | 24 | |
| | | EVL2TWBBFDOL4824 | 2384 | 48 | 24 | 24 | |
| | | EVL2TWBBFDOL5424 | 2446 | 54 | 24 | 24 | |
| | | EVL2TWBBFDOL6624 | 2720 | 66 | 24 | 24 | |
| | | | EVL2TWBBFDOR4224 | 2384 | 42 | 24 | 24 |
| | | | EVL2TWBBFDOR4824 | 2384 | 48 | 24 | 24 |
| | | | EVL2TWBBFDOR5424 | 2446 | 54 | 24 | 24 |
| | | | EVL2TWBBFDOR6624 | 2720 | 66 | 24 | 24 |
| | | | | | | | |
| | | | | | | | |

EVL2TW2FDOL - STORAGE TOWER W/SIDE ACCESS, FILE/FILE, RIGHT & LEFT HAND

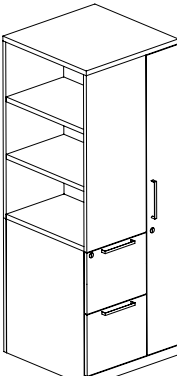
| | DESCRIPTION | PRODUCT CODE | LIST PRICE | DIMENSIONS/INCHES | | | |
|---|---|-----------------|-----------------|-------------------|----|----|----|
| | | | | H | D | W | |
|  <p>Right Hand Shown</p> | Storage Tower w/Side Access, File/File, | EVL2TW2FDOL4224 | 2301 | 42 | 24 | 24 | |
| | | EVL2TW2FDOL4824 | 2301 | 48 | 24 | 24 | |
| | | EVL2TW2FDOL5424 | 2370 | 54 | 24 | 24 | |
| | | EVL2TW2FDOL6624 | 2645 | 66 | 24 | 24 | |
| | | | EVL2TW2FDOR4224 | 2302 | 42 | 24 | 24 |
| | | | EVL2TW2FDOR4824 | 2302 | 48 | 24 | 24 |
| | | | EVL2TW2FDOR5424 | 2370 | 54 | 24 | 24 |
| | | | EVL2TW2FDOR6624 | 2645 | 66 | 24 | 24 |
| | | | | | | | |
| | | | | | | | |

UUSLF - PRIME SERIES BOX/BOX/FILE STORAGE TOWER

- Wardrobe right side/right hand unit; wardrobe left side/left hand unit - indicated by last character of model number.
- Wardrobe section includes top shelf and coat bar.
- Hinged door compartment of 50”H and 54”H includes one adjustable shelf; 66”H includes two adjustable open shelves.
- Box-Box-File configuration.
- Wardrobe section includes top perforations for ventilation.
- Three locks included - wardrobe door, hinged door shelving compartment and drawers.
- Ships assembled one carton.

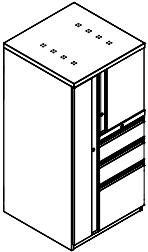
| | DESCRIPTION | PRODUCT CODE | LIST PRICE | DIMENSIONS/INCHES | | |
|---|--|---------------|------------|-------------------|----|----|
| | | | | H | D | W |
|  | Prime Series Box/Box File Storage Tower - 50” High | UUSLF4G24BCPL | 3196 | 49.6 | 24 | 24 |
| | | UUSLF4G24BCPR | 3196 | 49.6 | 24 | 24 |
| | Prime Series Box/Box File Storage Tower - 54” High | UUSLF4H24BCPL | 3196 | 53.6 | 24 | 24 |
| | | UUSLF4H24BCPR | 3196 | 53.6 | 24 | 24 |
| | Prime Series Box/Box/File Storage Tower - 65 7/8” High | UUSLF5024BCPL | 3341 | 65.6 | 24 | 24 |
| | | UUSLF5024BCPR | 3341 | 65.6 | 24 | 24 |

UUSLF - PRIME SERIES FILE/FILE STORAGE TOWER

- Wardrobe right side/right hand unit; wardrobe left side/left hand unit - indicated by last character of model number.
- Wardrobe section includes top shelf and coat bar.
- Hinged door compartment of 50”H and 54”H includes one adjustable shelf; 66”H includes two adjustable open shelves.
- File-File drawer configuration.
- Wardrobe section includes top perforations for ventilation.
- Three locks included - wardrobe door, hinged door shelving compartment and drawers.
- Ships assembled one carton.

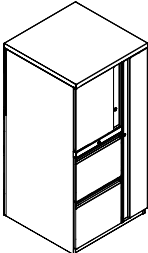
| | DESCRIPTION | PRODUCT CODE | LIST PRICE | DIMENSIONS/INCHES | | |
|---|---|---------------|------------|-------------------|----|----|
| | | | | H | D | W |
|  | Prime Series File/ File Storage Tower - 50” High | UUSLF4G24FCPL | 3196 | 49.6 | 24 | 24 |
| | | UUSLF4G24FCPR | 3196 | 49.6 | 24 | 24 |
| | Prime Series File/File Storage Tower - 54” High | UUSLF4H24FCPL | 3196 | 53.6 | 24 | 24 |
| | | UUSLF4H24FCPR | 3196 | 53.6 | 24 | 24 |
| | Prime Series File/File Storage Tower - 65 7/8” High | UUSLF5024FCPL | 3341 | 65.6 | 24 | 24 |
| | | UUSLF5024FCPR | 3341 | 65.6 | 24 | 24 |



UUSLS - PRIME SERIES SIDE OPENING BOX/BOX/FILE STORAGE TOWER

- Wardrobe right side/right hand unit; wardrobe left side/left hand unit - indicated by last character of model number.
- Wardrobe section includes top shelf and coat bar.
- 50”H and 54”H include open side shelf with one adjustable shelf; 66”H includes open side shelf with two adjustable shelves.
- Box-box-file drawer configuration.
- Wardrobe section includes top perforations for ventilation.
- Two locks included - wardrobe door and drawers.
- Ships assembled one carton.

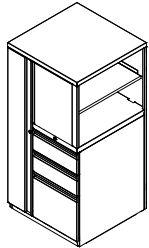

| DESCRIPTION | PRODUCT CODE | LIST PRICE | DIMENSIONS/INCHES | | |
|--|------------------------------------|--------------|-------------------|----------|----------|
| | | | H | D | W |
| Prime Series Side Opening Box/Box/File Storage Tower - 50” High | UUSLS4G2424BOPL UUSLS4G2424BOPR | 3361 3361 | 50 50 | 24 24 | 24 24 |
| Prime Series Side Opening Box/Box/File Storage Tower - 54” High | UUSLS4H2424BOPL UUSLS4H2424BOPR | 3531 3531 | 54 54 | 24 24 | 24 24 |
| Prime Series Side Opening Box/Box/File Storage Tower - 65 7/8” High | UUSLS502424BOPL UUSLS502424BOPR | 3589 3589 | 65.875 65.875 | 24 24 | 24 24 |

UUSLS - PRIME SERIES SIDE OPENING FILE/FILE STORAGE TOWER

- Wardrobe right side/right hand unit; wardrobe left side/left hand unit - indicated by last character of model number.
- Wardrobe section includes top shelf and coat bar.
- 50”H and 54”H include open side shelf with one adjustable shelf; 66”H includes open side shelf with two adjustable shelves.
- File-file drawer configuration.
- Wardrobe section includes top perforations for ventilation.
- Two locks included - wardrobe door and drawers.
- Ships assembled one carton.

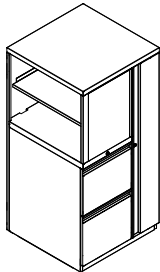

| DESCRIPTION | PRODUCT CODE | LIST PRICE | DIMENSIONS/INCHES | | |
|---|------------------------------------|--------------|-------------------|----------|----------|
| | | | H | D | W |
| Prime Series Side Opening File/File Storage Tower - 50” High | UUSLS4G2424FOPL UUSLS4G2424FOPR | 3511 3511 | 50 50 | 24 24 | 24 24 |
| Prime Series Side Opening File/File Storage Tower - 54” High | UUSLS4H2424FOPL UUSLS4H2424FOPR | 3531 3531 | 54 54 | 24 24 | 24 24 |
| Prime Series Side Opening File/File Storage Tower - 65 7/8” High | UUSLS502424FOPL UUSLS502424FOPR | 3589 3589 | 65.875 65.875 | 24 24 | 24 24 |

CREDENZA, BOX/FILE AND OPEN

- All lateral files feature drawer interlocking system
- All file drawers come with adjustable rails for legal or letter size hanging folders
- Locks are standard on all units and match pull finish
- File drawers are mounted on full extension ball bearing slides
- B/F Drawer Width -- 24" w on 48" w unit, 30" w on 54" w and 60" w units, 36" w on 66" w and 72" w units
- Two credenza spacers may be installed between a worksurface and credenza for support

EVL2CRBFO - BOX/FILE/OPEN CREDENZA, 20" H

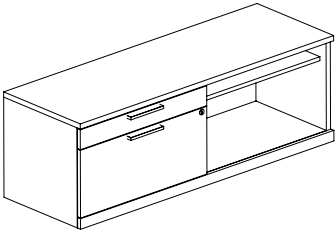
| DESCRIPTION | PRODUCT CODE | LIST PRICE | DIMENSIONS/INCHES | | |
|---|---------------|------------|-------------------|----|----|
| | | | H | D | W |
| Box/File/Open Credenza  | EVL2CRBFO2048 | 2020 | 20 | 48 | 20 |
| | EVL2CRBFO2054 | 2206 | 20 | 54 | 20 |
| | EVL2CRBFO2060 | 2343 | 20 | 60 | 20 |
| | EVL2CRBFO2066 | 2459 | 20 | 66 | 20 |
| | EVL2CRBFO2072 | 2549 | 20 | 72 | 20 |

EVL2CROBF - OPEN/BOX/FILE CREDENZA, 20" H

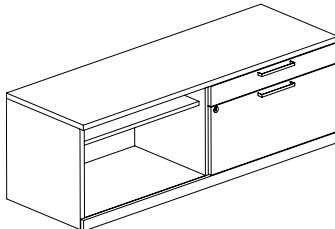
| DESCRIPTION | PRODUCT CODE | LIST PRICE | DIMENSIONS/INCHES | | |
|---|---------------|------------|-------------------|----|----|
| | | | H | D | W |
| Open/Box/File Credenza  | EVL2CROBF2048 | 2020 | 20 | 48 | 20 |
| | EVL2CROBF2054 | 2206 | 20 | 54 | 20 |
| | EVL2CROBF2060 | 2343 | 20 | 60 | 20 |
| | EVL2CROBF2066 | 2459 | 20 | 66 | 20 |
| | EVL2CROBF2072 | 2549 | 20 | 72 | 20 |



CREDENZA, SLIDING GLASS DOOR

- Sliding Door Credenzas are split evenly so door may cover either side
- Sliding door credenzas do not lock
- Two credenza spacers may be installed between a worksurface and credenza for support

EVL2CRGSD - SLIDING GLASS DOOR CREDENZA, 20”H

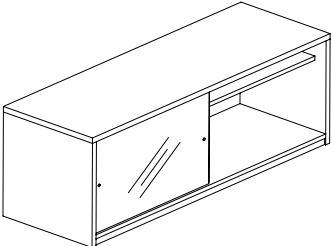
| DESCRIPTION | PRODUCT CODE | LIST PRICE | DIMENSIONS/INCHES | | |
|--|---------------|------------|-------------------|----|----|
| | | | H | D | W |
|  <p>Sliding Glass Door Credenza</p> | EVL2CRGSD2048 | 2705 | 20 | 48 | 20 |
| | EVL2CRGSD2060 | 2973 | 20 | 60 | 20 |
| | EVL2CRGSD2072 | 3254 | 20 | 72 | 20 |

EVWSSL - CREDENZA TO WORKSURFACE SPACER

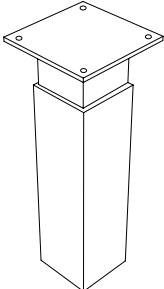
| DESCRIPTION | PRODUCT CODE | LIST PRICE | DIMENSIONS/INCHES | | |
|--|--------------|------------|-------------------|---|---|
| | | | H | D | W |
|  <p>Credenza to Worksurface Spacer</p> | EVWSSL08 | 77 | 8 | 3 | 3 |

| SO# | | PO# | | TAG# | | DATE | | | |
|------|------------|------|------------|------|------------|------|------------|------|------------|
| KEY# | SETS REQ'D | KEY# | SETS REQ'D | KEY# | SETS REQ'D | KEY# | SETS REQ'D | KEY# | SETS REQ'D |
| 401 | | 431 | | 461 | | 491 | | 521 | |
| 402 | | 432 | | 462 | | 492 | | 522 | |
| 403 | | 433 | | 463 | | 493 | | 523 | |
| 404 | | 434 | | 464 | | 494 | | 524 | |
| 405 | | 435 | | 465 | | 495 | | 525 | |
| 406 | | 436 | | 466 | | 496 | | 526 | |
| 407 | | 437 | | 467 | | 497 | | 527 | |
| 408 | | 438 | | 468 | | 498 | | 528 | |
| 409 | | 439 | | 469 | | 499 | | 529 | |
| 410 | | 440 | | 470 | | 500 | | 530 | |
| 411 | | 441 | | 471 | | 501 | | 531 | |
| 412 | | 442 | | 472 | | 502 | | 532 | |
| 413 | | 443 | | 473 | | 503 | | 533 | |
| 414 | | 444 | | 474 | | 504 | | 534 | |
| 415 | | 445 | | 475 | | 505 | | 535 | |
| 416 | | 446 | | 476 | | 506 | | 536 | |
| 417 | | 447 | | 477 | | 507 | | 537 | |
| 418 | | 448 | | 478 | | 508 | | 538 | |
| 419 | | 449 | | 479 | | 509 | | 539 | |
| 420 | | 450 | | 480 | | 510 | | 540 | |
| 421 | | 451 | | 481 | | 511 | | 541 | |
| 422 | | 452 | | 482 | | 512 | | 542 | |
| 423 | | 453 | | 483 | | 513 | | 543 | |
| 424 | | 454 | | 484 | | 514 | | 544 | |
| 425 | | 455 | | 485 | | 515 | | 545 | |
| 426 | | 456 | | 486 | | 516 | | 546 | |
| 427 | | 457 | | 487 | | 517 | | 547 | |
| 428 | | 458 | | 488 | | 518 | | 548 | |
| 429 | | 459 | | 489 | | 519 | | 549 | |
| 430 | | 460 | | 490 | | 520 | | 550 | |

| | | | | |
|-------------|-------------|-------------|-------------|-------------|
| 401 - 430 = | 431 - 460 = | 461 - 490 = | 491 - 520 = | 521 - 550 = |
|-------------|-------------|-------------|-------------|-------------|

Total:

NOTE : If Key Alike Instructions are not submitted to EVOLVE with the Customer's Purchase Order, all components will be keyed randomly.



accessories

EVHTVM - TV MOUNT

- Laminate panel with two mounting brackets to be installed on Evolve panels.
- TV Mount can be installed on panel of equal width or both brackets can be attached in middle for installing on single connector.
- TV frame not included, TV frame to be ordered separately.
- Holds up to 55" TV with a max load of 86 lbs.
- Note: TV frame must be securely attached to laminate panel. Care should be taken to attach TV frame using correct fasteners. Failure to do so may result in collapse of unit and subsequent possible injury.

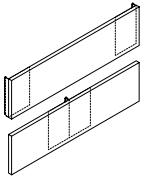
| DESCRIPTION | PRODUCT CODE | LIST PRICE | DIMENSIONS/INCHES | | |
|--|--------------|------------|-------------------|----|---|
| | | | H | W | D |
|  TV Mount | EVHTVM24 | 223 | 11 | 24 | 1 |
| | EVHTVM30 | 239 | 11 | 30 | 1 |
| | EVHTVM36 | 259 | 11 | 36 | 1 |
| | EVHTVM42 | 279 | 11 | 42 | 1 |

EVATB - TACK BOARD

- Provide a tackable surface for notes and memos in a work area.
- Includes two pairs of panel-mounting brackets.
- Only fabric must be specified.
- 17" to be installed under EVSOF13 or EVSOF16
- 21" specified for use under overhead shelf or storage bin.
- 24" for use without any overheads.
- All tackboards are 0.25" in thickness.

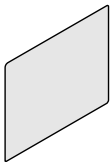
| DESCRIPTION | PRODUCT CODE | LIST PRICE | | DIMENSIONS/INCHES | | |
|--|--------------|------------|-----|-------------------|------|------|
| | | Gr1 | Gr2 | H | W | D |
|  Tack Board - 17" High | EVATB1730 | 304 | 317 | 17 | 30 | 0.25 |
| | EVATB1736 | 349 | 358 | 17 | 36 | 0.25 |
| | EVATB1742 | 395 | 407 | 17 | 42 | 0.25 |
| | EVATB1748 | 442 | 454 | 17 | 48 | 0.25 |
| | EVATB1754 | 490 | 503 | 17 | 54 | 0.25 |
| | EVATB1760 | 534 | 553 | 17 | 60 | 0.25 |
| Tack Board - 21" High | EVATB2124 | 281 | 296 | 21 | 24 | 0.25 |
| | EVATB2130 | 304 | 318 | 21 | 30 | 0.25 |
| | EVATB2136 | 349 | 358 | 21 | 36 | 0.25 |
| | EVATB2142 | 395 | 411 | 21 | 42 | 0.25 |
| | EVATB2148 | 444 | 457 | 21 | 48 | 0.25 |
| | EVATB2154 | 488 | 509 | 21 | 54 | 0.25 |
| Tack Board - 24" High | EVATB2160 | 534 | 556 | 21 | 60 | 0.25 |
| | EVATB2430 | 304 | 319 | 24 | 30 | 0.25 |
| | EVATB2436 | 349 | 361 | 24 | 36 | 0.25 |
| | EVATB2442 | 395 | 412 | 24 | 42 | 0.25 |
| | EVATB2448 | 444 | 459 | 24 | 48 | 0.25 |
| | EVATB2454 | 488 | 512 | 24 | 54 | 0.25 |
| EVATB2460 | 534 | 556 | 24 | 60 | 0.25 | |

EVFPDXXXWS - WORKSURFACE FELT DIVIDER

- Privacy felt divider integrated into an aluminum top trim.
- Attaches on top of a worksurface to add privacy or divide space.
- Must be used at connector location.
- Includes aluminum trim with channel, felt tile and brackets.
- 9 mm felt material is tackable and comes in 9 different colors. Please specify felt finish.
- Aluminum extrusion and brackets available in standard paint finishes.
- Felt tile and attachment hardware to ship separately.

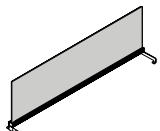
| DESCRIPTION | PRODUCT CODE | LIST PRICE | DIMENSIONS/INCHES | | |
|--|--------------|------------|-------------------|----|---|
| | | | H | W | D |
|  Felt Divider | EVFPD1818WS | 206 | 18 | 18 | |
| | EVFPD1824WS | 230 | 18 | 24 | |
| | EVFPD1830WS | 259 | 18 | 30 | |
| | EVFPD1836WS | 282 | 18 | 36 | |



EVAWB - WHITE MARKER BOARD

- Provides a writing surface within a work area.
- Includes two pairs of panel-mounting brackets.
- 21" specified for use under overhead shelf or storage bin.
- 24" for use without any overhangs.

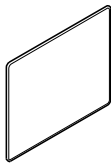
| | DESCRIPTION | PRODUCT CODE | LIST PRICE | DIMENSIONS/INCHES | | |
|---|-------------------------------|--------------|------------|-------------------|----|---|
| | | | | H | W | D |
|  | White Marker Board - 21" High | EVAWB2130 | 325 | 21 | 30 | |
| | | EVAWB2136 | 367 | 21 | 36 | |
| | | EVAWB2142 | 413 | 21 | 42 | |
| | | EVAWB2148 | 480 | 21 | 48 | |
| | White Marker Board - 24" High | EVAWB2430 | 325 | 24 | 30 | |
| | | EVAWB2436 | 367 | 24 | 36 | |
| | | EVAWB2442 | 413 | 24 | 42 | |
| | | EVAWB2448 | 480 | 24 | 48 | |

EVAMT - MARKER TRAY

- Provides a tray for storage of markers, erasers, etc.
- Attaches to the bottom of the White Marker Board.
- Available in standard and premium paint selections. See Textiles and Finishes (page 278) for complete offerings and conditions.

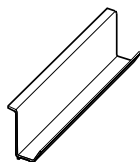
| | DESCRIPTION | PRODUCT CODE | LIST PRICE | DIMENSIONS/INCHES | | |
|--|-------------|--------------|------------|-------------------|----|---|
| | | | | H | W | D |
|  | Marker Tray | EVAMT12 | 21 | | 12 | |

EVALB2 - LOAD BAR - TOP

- Enables accessory items to be hung from a panel.
- Includes end caps and mounting brackets.
- Can be panel mounted.
- Can connect to EVALB2-2 and/or EVALB2-3 Load Bars to create a multi-level load bar or "Slat Wall"
- Note: can be used on its own.
- Available in standard and premium paint selections. See Textiles and Finishes (page 278) for complete offerings and conditions.

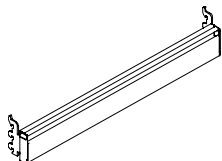
| | DESCRIPTION | PRODUCT CODE | LIST PRICE | DIMENSIONS/INCHES | | |
|---|----------------|--------------|------------|-------------------|----|---|
| | | | | H | W | D |
|  | Load Bar - Top | EVALB224 | 126 | 2.25 | 24 | 1 |
| | | EVALB230 | 131 | 2.25 | 30 | 1 |
| | | EVALB236 | 142 | 2.25 | 36 | 1 |
| | | EVALB242 | 150 | 2.25 | 42 | 1 |
| | | EVALB248 | 154 | 2.25 | 48 | 1 |
| | | EVALB254 | 160 | 2.25 | 54 | 1 |
| | | EVALB260 | 163 | 2.25 | 60 | 1 |

EVALB2-2 - LOAD BAR - MIDDLE

- Enables accessory items to be hung from a panel.
- Includes end caps and is to be used in conjunction with the Load Bar - Top (EVALB2). Mounting brackets NOT included.
- Can be panel mounted.
- Connects between EVALB2 and EVALB2-3 Load Bars to create a multi-level load bar or "Slat Wall"
- Note: Needs to be used in conjunction with both EVALB2 (as noted above) and EVALB2-3. Multiples of EVALB2-2 can be joined, one below the other, to create a "Slat Wall"

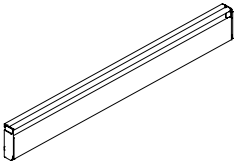
| DESCRIPTION | PRODUCT CODE | LIST PRICE | DIMENSIONS/INCHES | | |
|---|--------------|------------|-------------------|----|---|
| | | | H | W | D |
|  Load Bar - Middle | EVALB2-224 | 90 | 2.25 | 24 | 1 |
| | EVALB2-230 | 94 | 2.25 | 30 | 1 |
| | EVALB2-236 | 101 | 2.25 | 36 | 1 |
| | EVALB2-242 | 108 | 2.25 | 42 | 1 |
| | EVALB2-248 | 114 | 2.25 | 48 | 1 |
| | EVALB2-254 | 123 | 2.25 | 54 | 1 |
| | EVALB2-260 | 127 | 2.25 | 60 | 1 |

EVALB2-3 - LOAD BAR - BOTTOM

- Enables accessory items to be hung from a panel.
- Includes end caps and mounting brackets.
- Can be panel mounted.
- Connects between EVALB2-2 and EVALB2-3 Load Bars to create a multi-level load bar or "Slat Wall"
- Note: Needs to be used in conjunction with an EVALB2 or a combination of EVALB2 and EVALB2-2

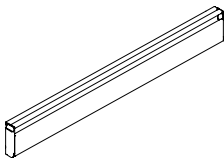
| DESCRIPTION | PRODUCT CODE | LIST PRICE | DIMENSIONS/INCHES | | |
|---|--------------|------------|-------------------|----|---|
| | | | H | W | D |
|  Load Bar - Bottom | EVALB2-324 | 123 | 2.25 | 24 | 1 |
| | EVALB2-330 | 127 | 2.25 | 30 | 1 |
| | EVALB2-336 | 131 | 2.25 | 36 | 1 |
| | EVALB2-342 | 142 | 2.25 | 42 | 1 |
| | EVALB2-348 | 151 | 2.25 | 48 | 1 |
| | EVALB2-354 | 158 | 2.25 | 54 | 1 |
| | EVALB2-360 | 161 | 2.25 | 60 | 1 |

EVALB - LOAD BAR

- Enables accessory items to be hung from a panel.
- Includes end caps and mounting brackets.
- Can be panel or wall mounted.
- Must specify finish.
- Attachment slot dimensions = 0.115" W x 0.240" H.
- Slatwall mounted monitor arms will NOT hang on EVALB - load bar.

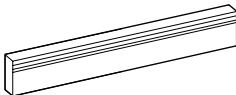
| DESCRIPTION | PRODUCT CODE | LIST PRICE | DIMENSIONS/INCHES | | |
|--|--------------|------------|-------------------|----|---|
| | | | H | W | D |
|  Load Bar | EVALB24 | 159 | 2.25 | 24 | 1 |
| | EVALB30 | 175 | 2.25 | 30 | 1 |
| | EVALB36 | 190 | 2.25 | 36 | 1 |
| | EVALB42 | 220 | 2.25 | 42 | 1 |
| | EVALB48 | 257 | 2.25 | 48 | 1 |
| | EVALB54 | 270 | 2.25 | 54 | 1 |
| | EVALB60 | 292 | 2.25 | 60 | 1 |

EVHOMB - OFF MODULE WORKSURFACE BRACKET

- Supports the worksurface in the work station corner in the case where an adjoining panel is wider than the worksurface.
- Enhances the stability of the worksurface.
- Can be used only in conjunction with the Top Load Bar EVALB2xx (xx being the panel width of adjoining panel).
- Available in black only.
- Top Load Bar EVALB2xx must be ordered separately.

| DESCRIPTION | PRODUCT CODE | LIST PRICE | DIMENSIONS/INCHES | | |
|-------------|--------------|------------|-------------------|---|---|
| | | | H | W | D |

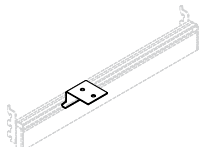
| | | | | | |
|---|---------|----|-----|---|------|
|  Bracket | EVHOMB1 | 29 | 1.6 | 3 | 2.73 |
|---|---------|----|-----|---|------|



EVAFWMXXP - WIRE MANAGER

- PET Wire manager installed under worksurface
- Including attachment brackets
- Available in standard felt colors

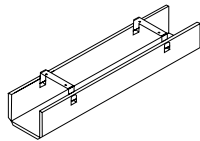

| DESCRIPTION | PRODUCT CODE | LIST PRICE | DIMENSIONS/INCHES | | |
|------------------|--------------|------------|-------------------|----|---|
| | | | H | W | D |
| PET Wire Manager | EVAFWM22P | 128 | 3.375 | 22 | 4 |
| | EVAFWM28P | 147 | 3.375 | 28 | 4 |
| | EVAFWM34P | 162 | 3.375 | 34 | 4 |

EVAFWMXXPL - WIRE MANAGER FOR 90 DEGREE CORNER-LEFT

- PET Wire manager installed under worksurface
- Including attachment brackets
- Available in standard felt colors

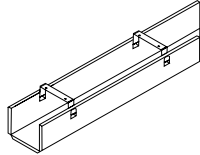

| DESCRIPTION | PRODUCT CODE | LIST PRICE | DIMENSIONS/INCHES | | |
|---|--------------|------------|-------------------|----|---|
| | | | H | W | D |
| PET Wire Manager 90 Degree Corner - Left | EVAFWM26PL | 141 | 3.375 | 26 | 4 |
| | EVAFWM32PL | 158 | 3.375 | 32 | 4 |
| | EVAFWM38PL | 172 | 3.375 | 38 | 4 |

EVAFWMXXPR - FELT WIRE MANAGER FOR 90 DEGREE CORNER-RIGHT

- Felt Wire manager installed under worksurface
- Including attachment brackets
- Available in standard felt colors

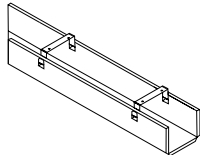

| DESCRIPTION | PRODUCT CODE | LIST PRICE | DIMENSIONS/INCHES | | |
|--|--------------|------------|-------------------|----|---|
| | | | H | W | D |
| PET Wire Manager 90 Degree Corner - Right | EVAFWM26PR | 141 | 3.375 | 26 | 4 |
| | EVAFWM32PR | 158 | 3.375 | 32 | 4 |
| | EVAFWM38PR | 172 | 3.375 | 38 | 4 |

EVABB01 - BINDER BIN

- Must be ordered in conjunction with a load bar option.
- Can be used with slat wall module.
- Available in standard and premium paint selections. See Textiles and Finishes (page 240) for a complete list of offerings and conditions.

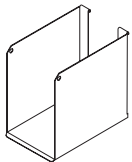
| | DESCRIPTION | PRODUCT CODE | LIST PRICE | DIMENSIONS/INCHES | | |
|---|-------------|--------------|------------|-------------------|---|-------|
| | | | | H | W | D |
|  | Binder Bin | EVABB01 | 82 | 9 | 4 | 10.25 |

EVALT01 - LETTER TRAY

- Must be ordered in conjunction with a load bar option.
- Can be used with slat wall module.
- Available in standard and premium paint selections. See Textiles and Finishes (page 240) for a complete list of offerings and conditions.

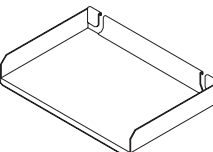
| | DESCRIPTION | PRODUCT CODE | LIST PRICE | DIMENSIONS/INCHES | | |
|---|-------------|--------------|------------|-------------------|------|------|
| | | | | H | W | D |
|  | Letter Tray | EVALT01 | 65 | 2 | 13.5 | 9.25 |

EVALT02 - LEGAL TRAY

- Must be ordered in conjunction with a load bar option.
- Can be used with slat wall module.
- Available in standard and premium paint selections. See Textiles and Finishes (page 240) for a complete list of offerings and conditions.

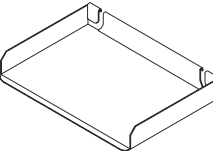
| | DESCRIPTION | PRODUCT CODE | LIST PRICE | DIMENSIONS/INCHES | | |
|---|-------------|--------------|------------|-------------------|------|------|
| | | | | H | W | D |
|  | Legal Tray | EVALT02 | 74 | 1.75 | 14.7 | 8.75 |

EVASS01 - SLANT SORTER

- Must be ordered in conjunction with a load bar option.
- Can be used with slat wall module.
- Available in standard and premium paint selections. See Textiles and Finishes (page 240) for a complete list of offerings and conditions.

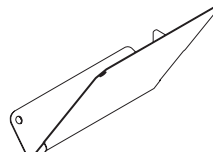
| | DESCRIPTION | PRODUCT CODE | LIST PRICE | DIMENSIONS/INCHES | | |
|---|--------------|--------------|------------|-------------------|---|-------|
| | | | | H | W | D |
|  | Slant Sorter | EVASS01L | 53 | 9.5 | 5 | 10.25 |
| | | EVASS01R | 53 | 9.5 | 5 | 10.25 |



EVAMB01 - MEDIA BIN

- Must be ordered in conjunction with a load bar option.
- Can be used with slat wall module.
- Available in standard and premium paint selections. See Textiles and Finishes (page 240) for a complete list of offerings and conditions.

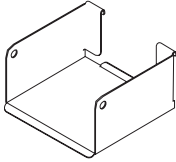
| | DESCRIPTION | PRODUCT CODE | LIST PRICE | DIMENSIONS/INCHES | | |
|---|-------------|--------------|------------|-------------------|------|------|
| | | | | H | W | D |
|  | Media Bin | EVAMB01 | 65 | 3 | 5.75 | 5.25 |

EVAUT01 - UTILITY TRAY

- Must be ordered in conjunction with a load bar option.
- Can be used with slat wall module.
- Available in standard and premium paint selections. See Textiles and Finishes (page 240) for a complete list of offerings and conditions.

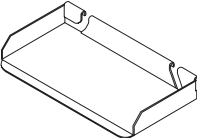
| | DESCRIPTION | PRODUCT CODE | LIST PRICE | DIMENSIONS/INCHES | | |
|---|--------------|--------------|------------|-------------------|-----|------|
| | | | | H | W | D |
|  | Utility Tray | EVAUT01 | 44 | 1 | 8.5 | 3.75 |

EVAFS01 - FLIP SORTER

- Must be ordered in conjunction with a load bar option.
- Can be used with slat wall module.
- Comes with nickel plated wire.
- Available in standard and premium paint selections. See Textiles and Finishes (page 240) for a complete list of offerings and conditions.

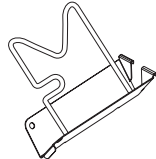
| | DESCRIPTION | PRODUCT CODE | LIST PRICE | DIMENSIONS/INCHES | | |
|---|-------------|--------------|------------|-------------------|------|------|
| | | | | H | W | D |
|  | Flip Sorter | EVAFS01 | 61 | 9.25 | 2.75 | 9.25 |

EVAPP01 - MAIL BOX

- Must be ordered in conjunction with a load bar option.
- Can be used with slat wall module.
- Available in standard and premium paint selections. See Textiles and Finishes (page 240) for a complete list of offerings and conditions.

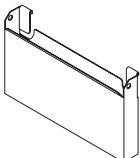
| | DESCRIPTION | PRODUCT CODE | LIST PRICE | DIMENSIONS/INCHES | | |
|---|-------------|--------------|------------|-------------------|----|------|
| | | | | H | W | D |
|  | Mail Box | EVAPP01 | 104 | 9 | 12 | 2.75 |

EVATH01 - TELEPHONE HOLDER

- Must be ordered in conjunction with a load bar option.
- Can be used with slat wall module.
- Available in standard and premium paint selections. See Textiles and Finishes (page 240) for a complete list of offerings and conditions.

| | DESCRIPTION | PRODUCT CODE | LIST PRICE | DIMENSIONS/INCHES | | |
|--|-------------|--------------|------------|-------------------|---|---|
| | | | | H | W | D |

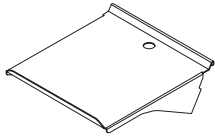

| | | | | | |
|------------------|---------|----|---|---|----|
| Telephone Holder | EVATH01 | 99 | 2 | 9 | 10 |
|------------------|---------|----|---|---|----|

EVANP02 - NAME PLATE

- Name Plate attached to 1" increment slots.
- Available in single sided (parallel to panel) or double sided (perpendicular to panel) for isle application displaying name on both sides.
- Injection molded frame and die cast base with black rubberized finish.
- Includes two slide-in name cards, steel brackets and fasteners.
- Available in black only.
- Free template for additional slide-in name cards are available at http://evolvefurnituregroup.com/PDFs/Name_Plate_Template.doc

| | DESCRIPTION | PRODUCT CODE | LIST PRICE | DIMENSIONS/INCHES | | |
|--|-------------|--------------|------------|-------------------|---|---|
| | | | | H | W | D |

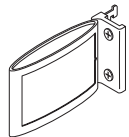

| | | | | | |
|------------|---------|-----|------|-----|------|
| Name Plate | EVANP02 | 150 | 3.30 | 5.3 | 1.25 |
|------------|---------|-----|------|-----|------|

EVACH01 - COAT HOOK

- Panel mounted coat hook.
- Available in all standard Evolve paint colors except Blizzard (BZD), Fog (FOG) and Stone Dust (SDT). Also available in premium paint selections (minimum quantities required to order).

| | DESCRIPTION | PRODUCT CODE | LIST PRICE | DIMENSIONS/INCHES | | |
|--|-------------|--------------|------------|-------------------|---|---|
| | | | | H | W | D |

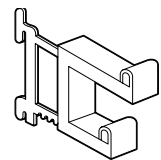

| | | | | | |
|-----------|---------|-----|--|---|-----|
| Coat Hook | EVACH01 | 110 | | 3 | .75 |
|-----------|---------|-----|--|---|-----|

EVACH02 - PANEL COAT HOOK

- Panel mounted coat hook.
- Installed at panel top in groove between module and top trim.
- Available in standard and premium paint colors.
- Priced per six piece package.

| | DESCRIPTION | PRODUCT CODE | LIST PRICE | DIMENSIONS/INCHES | | |
|--|-------------|--------------|------------|-------------------|---|---|
| | | | | H | W | D |

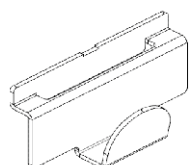

| | | | | | |
|-----------------|---------|-----|--|-----|------|
| Panel Coat Hook | EVACH02 | 126 | | 2.5 | .625 |
|-----------------|---------|-----|--|-----|------|



EVWAKM01 - SOFT TOUCH KEYBOARD SUPPORT MECHANISM

- Height range 6" (+1.0"/-5.0").
- Soft touch knob tilt adjustable range +15°/-15°.
- 360° base swivel.
- Soft touch knob for simultaneous height and tilt adjustment.
- Spring-assisted mechanism helps counter balance weight of keyboard and tray.
- Low profile design for maximum leg room.
- Includes 21.75" under worksurface glide track as standard. Optional 12" and 18" glide tracks are available at no upcharge. Contact Evolve Customer Support for details.
- Keyboard support mechanisms and trays available in Black only.

| | DESCRIPTION | PRODUCT CODE | LIST PRICE | DIMENSIONS/INCHES | | |
|--|-------------|--------------|------------|-------------------|---|---|
| | | | | H | W | D |

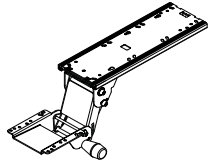

Soft Touch Keyboard Support Mechanism

EVWAKM01

319

EVWAKT01 - MDF TRAY WITH SLIDING MOUSE SUPPORT

- Formed MDF tray with textured finish and a foam anti-skid mat.
- Sliding retractable mouse support slides below tray for left or right mouse positioning.
- Extends 9.91" beyond the end of the keyboard tray.
- Keyboard support mechanisms and trays available in Black only.

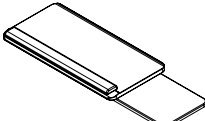
| | DESCRIPTION | PRODUCT CODE | LIST PRICE | DIMENSIONS/INCHES | | |
|---|-------------------------------------|--------------|------------|-------------------|------|---|
| | | | | H | W | D |
|  | MDF Tray with Sliding Mouse Support | EVWAKT01 | 322 | 21.3 | 10.5 | |

EVWAKT04 - 1/2" HDPE TRAY WITH HEIGHT ADJUSTABLE MOUSE SUPPORT

- 1/2" thick high density polyethylene with textured finish.
- HDPE includes removable plug-in, gel free foam palm rest and anti-skid straps.
- Height adjustable mouse support with ergonomic adjustment of tilt, swivel and height adjustment.
- Can mount left or right and includes mouse fence and cable manager.
- Keyboard support mechanisms and trays available in Black only.

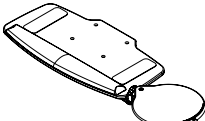
| | DESCRIPTION | PRODUCT CODE | LIST PRICE | DIMENSIONS/INCHES | | |
|---|---|--------------|------------|-------------------|------|---|
| | | | | H | W | D |
|  | 1/2" HDPE Tray with Height Adjustable Mouse Support | EVWAKT04 | 499 | 23 | 11.5 | |



KEYBOARD COMBINATION CHART - PACKAGED CODES

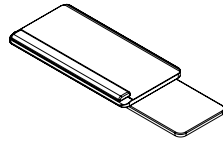

EVWAKT01

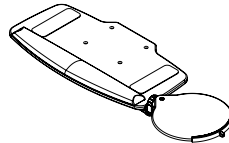

EVWAKT04

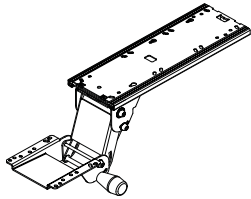

EVWAKM01

EVWAKK101
636

EVWAKK104
813

MONITOR ARM SPECIFICATIONS (APPLIES TO ALL EVOLVE MONITOR ARMS LISTED BELOW):

- VESA mounting plate contains 75mm & 100mm mounting configuration.
- VESA plate head is fully adjustable with 180° of tilt, 180° of swivel and 360° of rotation for portrait to landscape viewing.
- Keyhole slots in VESA plate for quick mounting of display screen.
- Counterbalance spring mechanism does not contain gas cylinders (that are prone to leakage).
- Cable management provided on arm swivel joints.
- Arm components manufactured from 100% recyclable aluminum dye cast material, providing stability and durability.
- 13" arm height adjustment on 11" stainless steel pole.
- Pole support ring doubles as cable manager.
- 360° of arm swivel around pole.
- Desk clamp and grommet mounting options standard on pole applications.

EVLCD03 - MONITOR ARM - SINGLE SCREEN/SINGLE EXTENSION

- Display viewing - 180° of tilt, 180° of swivel and 360° of rotation.
- Quick-release VESA plate included.
- 9" pole adjustment.
- Available in White (WHT), Black (BLK) and Silver (SIL). Post is chromed.

| DESCRIPTION | PRODUCT CODE | LIST PRICE | DIMENSIONS/INCHES | | |
|-------------|--------------|------------|-------------------|---|---|
| | | | H | D | W |

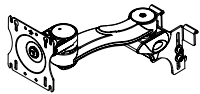

Monitor Arm - Single Screen
Single Extension

EVLCD03

539

EVLCD04 - MONITOR ARM - SINGLE SCREEN/DUAL EXTENSION/HEIGHT ADJUSTABLE

- Frees up valuable worksurface space and supports a sit/stand working posture.
- Attaches to any standard worksurface with a flush edge, or through a grommet.
- Monitor arm adjusts from 3" to 12" above worksurface.
- Counterbalanced arm provides an additional 13" of height adjustment.
- Monitor connecting bracket swivels 360° and tilts +/- 90° (180°).
- Double extension has 19" of back and forth movement to allow for different vocal depths of viewing comfort.
- Built-in cable clips on underside of extension arms and pole base allows organized cable management.
- Quick-release VESA plate included.
- Available in White (WHT), Black (BLK) and Silver (SIL). Post is chromed.

| DESCRIPTION | PRODUCT CODE | LIST PRICE | DIMENSIONS/INCHES | | |
|-------------|--------------|------------|-------------------|---|---|
| | | | H | W | D |

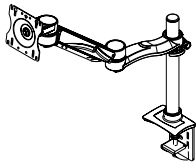

Monitor Arm - Single Screen
Dual Extension/Height Adjustable

EVLCD04

770

EVLCD05 - MONITOR ARM - DUAL SCREEN/DUAL EXTENSION

- Frees up valuable worksurface space.
- Used for side-by-side or back-to-back applications.
- Attaches to any standard worksurface with flush edge or through a grommet.
- Monitor arm adjusts from 3" to 12" above worksurface.
- Monitor connecting extension has 19" of back and forth movement to allow for different vocal depths of viewing comfort.
- Built-in cable clips on underside of extension arms and pole base allows organized cable management.
- Quick-release VESA plate included.
- Available in White (WHT), Black (BLK) and Silver (SIL). Post is chromed.

| DESCRIPTION | PRODUCT CODE | LIST PRICE | DIMENSIONS/INCHES | | |
|-------------|--------------|------------|-------------------|---|---|
| | | | H | W | D |

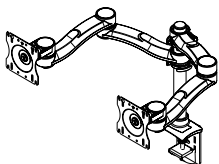

Monitor Arm - Dual Screen

EVLCD05

1131



EVLCD06 - MONITOR ARM - DUAL SCREEN/DUAL EXTENSION/HEIGHT ADJUSTABLE

- Frees up valuable worksurface space and supports a sit/stand working posture.
- Used for side-by-side or back-to-back applications.
- Attaches to any standard worksurface with flush edge or through a grommet.
- Monitor arm adjusts from 3" to 12" above worksurface.
- Counterbalanced arm provides an additional 13" of height adjustment.
- Monitor connecting bracket swivels 360° and tilts +/- 90° (180°).
- Double extension has 19" of back and forth movement to allow for different vocal depths of viewing comfort.
- Built in cable clips on underside of extension arms and pole base allows organized cable management.
- Quick-release VESA plate included.
- Available in White (WHT), Black (BLK) and Silver (SIL).
- Accommodates flat screen monitors up to 32" in size.

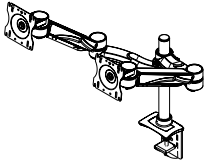
| | DESCRIPTION | PRODUCT CODE | LIST PRICE | DIMENSIONS/INCHES | | |
|---|---|--------------|------------|-------------------|---|---|
| | | | | H | W | D |
|  | Monitor Arm - Dual Screen Dual Extension/Height Adjustable | EVLCD06 | 1403 | | | |

EVLCD08 - MONITOR ARM - SINGLE SCREEN/DUAL EXTENSION

- 9 1/2" reach from center of pole to front of VESA plate.
- Display viewing - 180° of tilt, 180° of swivel and 360° of rotation.
- Quick-release VESA plate included.
- 9" pole adjustment.
- Available in White (WHT), Black (BLK) and Silver (SIL). Post is chromed.

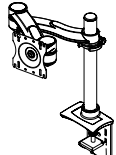
| | DESCRIPTION | PRODUCT CODE | LIST PRICE | DIMENSIONS/INCHES | | |
|--|---|--------------|------------|-------------------|---|---|
| | | | | H | W | D |
|  | Monitor Arm - Single Screen Dual Extension | EVLCD08 | 642 | | | |

EVLCD09 - SINGLE SCREEN MONITOR ARM - FOR 5 TO 20LBS

- Adjustable counterbalance cylinder provides smooth 14 1/2" of height adjustment with fingertip control - counterbalances monitors from 5 lbs. to 20 lbs.
- Double extension arms provide a maximum of 26 3/4" extension from the rear edge of the mounting surface to the VESA Plate for greater monitor adjustment on deep or corner workstations.
- Arms fold back to a minimum dimension of 4 1/2" to provide maximum desk utilization.
- Weight gauge provided to allow for quick and easy counterbalance adjustment of the arm prior to installing the screen.
- Saves time and guesswork especially for multiple arm installations.
- Die cast aluminum construction provides greater stability and contains high recycled material content with full recyclability.
- Adjustable rotation limiter to restrict arm rotation to 180°, preventing arms from hitting walls.
- Comes with all tools and mounting hardware for quick and easy installation (Tool-free).
- Available in White (WHT), Black (BLK) and Silver Metallic (SIL). Post is chromed.

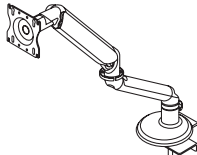
| | DESCRIPTION | PRODUCT CODE | LIST PRICE | DIMENSIONS/INCHES | | |
|---|--|--------------|------------|-------------------|---|-----|
| | | | | H | W | D |
|  | Single Screen Monitor Arm - For 5 to 20 lbs. | EVLCD09 | 718 | 38 | 6 | 8.5 |

EVCPU - CPU HOLDER

- CPU holder with soft touch knob.
- Vertical underside storage space.
- Maintains CPU at set height.
- Inside width adjustment 3.5" — 9.25"
- Inside vertical adjustment 12.25" — 22.25"
- Load rating: 85lbs.
- Available in black only.

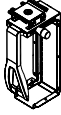
| | DESCRIPTION | PRODUCT CODE | LIST PRICE | DIMENSIONS/INCHES | | |
|---|-------------|--------------|------------|-------------------|------|------|
| | | | | H | W | D |
|  | CPU Holder | EVCPU01 | 347 | 14 | 8.25 | 7.75 |

EVCPU02 - CPU HOLDER ON GLIDE TRACK

- Accepts tower CPUs with a width range of 3.5" to 9.3" and a height range of 12.5" to 22.5".
- Soft touch knob for side clamp adjustment and bayonet lance for vertical height adjustment.
- 12" glide track mounted and 360-degree swivel for easy access to rear of CPU.
- Manufactured from steel and engineered resin, providing rugged durability and support.
- Available in Black only.

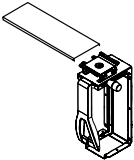
| | DESCRIPTION | PRODUCT CODE | LIST PRICE | DIMENSIONS/INCHES | | |
|---|---------------------------|--------------|------------|-------------------|---|---|
| | | | | H | W | D |
|  | CPU Holder on Glide Track | EVCPU02 | 367 | | | |



ACCESSORIES

EVATP - TOUCH-UP PAINT KIT

- Available in standard Evolve paint colors to facilitate easy touch-ups.
- 1/2 fl. ounce bottle (spray not available).
- Specify color.

| | DESCRIPTION | PRODUCT CODE | LIST PRICE | DIMENSIONS/INCHES | | |
|---|--------------------|--------------|------------|-------------------|---|---|
| | | | | H | W | D |
|  | Touch-Up Paint Kit | EVATP01 | 51 | | | |

textiles and finishes

Care and Cleaning

The following guide encompasses the Evolve System line.

The guide was compiled using information from our "raw" material suppliers and is relevant only to our standard offering finishes and textiles.

FABRICS

To extend the life of your upholstered panels, regularly dust the panel to prevent airborne particles from penetrating the fabric surface.

For light soiling, use a damp cloth and blot the spot with very slight pressure, taking care never to soak the fabric. Dry with a clean cloth by blotting - never rub fabric. More intense stains can be treated the same way, but with a mild detergent. Always test fabric first in an unseen area before using any cleaning method.

PANEL FRAMES

The panel frames are manufactured out of sturdy aluminum with a powder coated enamel paint finish. To clean the frames of the panels, and all hardware associated with the Evolve line, simply utilize a clean, damp cloth. For stubborn stains on the panel frames, you may consider adding a mild detergent.

GLAZED PANELS

Cleaning of the glazing in panels should only be done with a damp lint-free cloth. A mild detergent can be used if necessary. Do not use paper towels in combination with a window cleaner-this may cause scratches to the glazing.

WORKSURFACES

The worksurfaces are manufactured using primarily Nevamar Brand laminates as the exposed surface. To properly clean these areas, it is best to use a clean, damp cloth and circular motion to prevent streaks. For stubborn stains, you are able to add a mild detergent to the water. Be certain not to use an ammonia-based solution. It will react with the PVC, or wood edge trim, causing permanent damage to the contacted areas.

ACCESSORIES

The accessories sold with the Evolve product line can be simply cleaned with a clean, damp cloth. If they are really dirty, a mild, non-abrasive solution may be added. Wipe with a damp cloth after the solution, and finally, a dry cloth.

LAMINATES – THERMALLY FUSED & HIGH PRESSURE

| | |
|---------------------------|--------------|
| Absolute Acajou* | ACJ |
| Asian Night* | ASN |
| Avant Cherry* | AWC |
| Avant Honey* | AWH |
| Black* | BLK |
| Blizzard* | BZD |
| Brushed Cobalt* | BRC |
| Clear Maple* | CMB |
| Custom Grey | CGY |
| Dark Espresso* | DES |
| Designer White* | DWT |
| Fashionista | FAS |
| First Class | FCL |
| Noce Biondo | (NBL) |
| Noce Grigio | (NGL) |
| Noce Leggero | (NEL) |
| Noce Medio | (NML) |
| Quartered Mahogany* | QTM |
| Sheer Beauty | SBY |
| Stone Dust | SDT |
| Storm Grey | SOG |

| | |
|------------------------|------------|
| Walnut Heights* | WHE |
| Winter Cherry* | WCR |
| White Chocolate* | WHC |

Additional paint and laminates may be available. Contact Evolve Customer Support for details.

* Matching Wood Grain PVC edge available.

* PVC panel and connector trims are discontinued. Effective 12/2014

* 1 1/8" Worksurfaces are discontinued. Effective December 2014

PVC EDGE TRIM

| | |
|---------------------------|------------|
| Absolute Acajou | AAE |
| Asian Night | ASE |
| Avant Cherry | ACE |
| Avant Honey | AHE |
| Black | BLK |
| Blizzard | BZD |
| Brushed Cobalt | BRC |
| Charcoal | CHR |
| Clear Maple | CME |
| Dark Espresso* | DES |
| Designer White | DWE |
| Fashionista | FAS |
| First Class | FCL |
| Nevada | NEV |
| Quartered Mahogany* | QTM |
| Sheer Beauty | SBY |
| Silver | SIL |
| Taupe | TPE |
| Tungsten | TUN |
| Walnut Heights | WHE |
| Winter Cherry* | WCR |
| White Chocolate* | CBE |

* 1 7/16" HPW PVC Trim for Worksurfaces is not available in Dark Espresso (DES),

WOOD VENEER WORKSURFACES*

| | |
|--------------------------|------------|
| Almond Cherry | AMW |
| Amber Cherry | ACW |
| Biscotti | BTW |
| Cocoa Walnut | CAW |
| Coral | CRW |
| Dark Cherry | DCW |
| Dark Walnut | DWW |
| Espresso Walnut | EWV |
| Evening Oak | EVW |
| Grey on Oak | GRW |
| Hazlenut | HAW |
| Java | JAW |
| Latte Walnut | LTW |
| Mahogany on Walnut | MHW |
| Milestone | MTW |
| Natural Maple | MPW |
| Natural Walnut | NLW |
| Red Cherry | RCW |
| Umber Walnut | ULW |
| Vintage Cherry | VNW |
| Walnut | WLW |
| Warm Cherry | WCW |
| White Maple | WMW |

All wood veneer worksurfaces are 1.38" thick.

*Note: Wood veneer options for worksurfaces are available at an up charge and with an extended lead time. Contact Evolve Customer Support for details.

STANDARD PAINT & FRAME COLORS

(for application to trim, steel components, PVC, vertical and horizontal members)

| | |
|-----------------------------|------------|
| Black | BLK |
| Blizzard (Textured) | BZD |
| Charcoal | CHR |
| Designer White | DWT |
| Fog | FOG |
| Nevada | NEV |
| Silver | SIL |
| Stone Dust (Textured) | SDT |
| Taupe | TPE |
| Tungsten ^o | TUN |

Additional paint and laminates may be available. Contact Evolve Customer Support for details.

^oTungsten paint is subject to 10% upcharge EXCEPT on Worksurfaces, PVC items, or when PVC trim components are ordered separately.

PREMIUM PAINT & FRAME COLORS

| | |
|-----------------------|------------|
| Black Coffee* | BKC |
| Bone* | BNE |
| Business Grey* | BGR |
| Claret* | CLT |
| Dark Chocolate* | DCH |
| Desert Putty* | DPT |
| Grey* | GRY |
| Ice* | ICE |
| Ivory* | IVR |
| Light Grey* | LGR |
| Metro* | MET |
| Mocha* | MCH |
| Moss* | MOS |
| Navy* | NAV |
| Oyster* | OYS |
| Sky* | SKY |
| Stone* | STN |
| Storm Grey | SGR |
| Tahiti Sand* | TSA |
| Willow* | WIL |

*Premium paint selections are available on the following components: Panels (top trim and frame), Hardware, End-of run/Post Kits, and Accessories at a 22% upcharge. Storage with no upcharge.

*Please note all Double Wall Storage units must be ordered in a minimum quantity of 50 when ordering in a premium paint finish. Different model types can be combined to achieve the minimum quantity required. See pages 192-193 for affected models.

All special and premium paint match orders of 50 panels or less will incur a \$500 net setup fee. Panels, hardware, accessories and storage may be combined on orders to achieve minimum of 50 pieces or more and will not be subject to \$500 net set up fee. Add on orders will not have that charge for 90 days after the original order has shipped and must have the original PO# quoted otherwise they will not qualify for the program.

Global matte paint finishes are available on most Evolve Storage pieces without an up charge regardless of quantities.

All Mica and Metallic paint finishes will incur a minimum up charge of 10%.

All non-standard paint finishes must be approved by Evolve prior to placing an order.

ADA Overheads are not available in Evolve premium color paints. ADA Overheads are available in Evolve standard paint colors only.

Frames for all Open Panel models, all panel retainers, PVC components for panels and connectors are unavailable in premium or special/custom paint colors. They are available in standard Evolve paint colors only.



PANEL FABRICS – GRADE 1

Anchorage - 35% Post - consumer Recycled Polyester and 65% Pre -consumer Recycled Polyester

| | |
|---------------------|-------------|
| Birch | AN40 |
| Green Apple | AN41 |
| Lapis | AN42 |
| Straw | AN43 |
| Wolf | AN44 |
| Goose | AN45 |
| Angora | AN46 |
| Cumin | AN47 |
| Asteroid | AN48 |
| Geranium | AN49 |
| Thistle | AN50 |
| Graphite | AN51 |
| Slate | AN52 |
| Quarry Blue | AN53 |
| Onyx | AN54 |
| Pumpkin | AN55 |
| Red Delicious | AN56 |
| Sunshine | AN57 |
| Waterfall | AN59 |
| Vanilla | AN61 |
| Vanilla | AN61 |
| Cobalt | AN62 |
| Cloud | AN64 |

Aurora - 100% Polyester, 80% minimum Post-Consumer Recycled Polyester

| | |
|---------------|-------------|
| Cloud | AU20 |
| Seal | AU21 |
| Fog | AU22 |
| Pewter | AU23 |
| Granite | AU24 |
| Oat | AU25 |
| Coconut | AU26 |
| Latte | AU27 |
| Lake | AU28 |
| Frost | AU29 |

Chance - 63% Virgin Polyester, 37% Post-Consumer Recycled Polyester

| | |
|----------------|-------------|
| Mist | CN51 |
| Dill | CN52 |
| Island | CN53 |
| Plaza | CN54 |
| Tranquil | CN55 |
| Malt | CN56 |
| Navajo | CN57 |
| Prairie | CN58 |
| Cinder | CN59 |
| Oasis | CN66 |

Linea - 100% Post Consumer Recycled Polyester

| | |
|------------------|-------------|
| Queue | LN41 |
| Cord | LN42 |
| Twine | LN43 |
| Thread | LN44 |
| Contour | LN45 |
| Silhouette | LN46 |
| Cable | LN47 |
| Route | LN48 |

Lisbon - 80% Polyester, 20% Post-Consumer Recycled Polyester

| | |
|-----------------|-------------|
| Gesso | LS11 |
| Dusk | LS12 |
| Grey | LS13 |
| Ivory | LS14 |
| Henna | LS15 |
| Nocturnal | LS16 |
| Moss | LS17 |
| Navy | LS18 |
| Buff | LS19 |
| Spa | LS20 |

Loopy - 100% Recycled Polyester

| | |
|-----------------|-------------|
| Oyster | LP60 |
| Putty | LP61 |
| Marble | LP62 |
| Hazelnut | LP63 |
| Latte | LP64 |
| Bay | LP65 |
| Wild Rice | LP66 |
| Harbor | LP67 |

Melody - 100% Recycled Polyester

| | |
|----------------|-------------|
| Spray | ME40 |
| Pond | ME41 |
| Sand Bar | ME42 |
| Silt | ME43 |
| Pebble | ME44 |
| Lake | ME45 |
| Gravel | ME46 |
| Boulder | ME47 |

Merge - 100% Polyester, 75% minimum Post-Consumer Recycled Polyester

| | |
|---------------------|-------------|
| Fawn | MG20 |
| Marshmallow | MG21 |
| Driftwood | MG22 |
| Dove | MG23 |
| Graphite | MG24 |
| Slate | MG25 |
| Eucalyptus | MG26 |
| Fire Engine | MG27 |
| Mediterranean | MG28 |
| Midnight | MG29 |

Pinpoint - 100% Post-Consumer Recycled Polyester

| | |
|----------------|-------------|
| Bliss | PN11 |
| Delight | PN12 |
| Dune | PN13 |
| Infusion | PN14 |
| Ebony | PN15 |
| Fresh | PN16 |
| Carrot | PN17 |
| Splash | PN18 |
| Vibe | PN19 |
| Gala | PN20 |

Streak - 100% Recycled Polyester

| | |
|---------------|-------------|
| Beach | SR81 |
| Shade | SR86 |
| Stretch | SR88 |
| Sprint | SR89 |
| Roll | SR91 |
| Dart | SR92 |
| Zoom | SR93 |
| Splash | SR94 |
| Whiz | SR95 |
| Flash | SR96 |

Tek - 100% Recycled Polyester

| | |
|---------------|-------------|
| Finesse | TX60 |
| Grain | TX61 |
| Essence | TX62 |
| Warp | TX64 |
| Mesh | TX67 |
| Form | TX69 |
| Spice | TX71 |
| Glacier | TX72 |
| Spring | TX73 |
| Harmony | TX74 |
| Smoke | TX75 |
| Pebble | TX76 |

Terrace - 100% Post-Consumer Recycled Polyeste

| | |
|----------------------|-------------|
| Lotus | TC60 |
| Tigerlily | TC61 |
| Shadow | TC62 |
| Cobble | TC63 |
| Cherry Blossom | TC64 |
| Bluebell | TC65 |
| Apple | TC66 |
| Haze | TC67 |
| Cerise | TC68 |
| Twilight | TC69 |
| Wintergreen | TC70 |
| Ironwork | TC71 |
| Flirt | TC73 |
| Echo | TC74 |
| Glacier | TC75 |

PANEL FABRICS— GRADE 2

Cyclone - 56% post-consumer recycled polyester and 44% polyester.

| | |
|-----------------------|-------------|
| Stove Pipe | IM37 |
| Stainless..... | IM40 |
| Polished Pewter | IM41 |
| Welded Steel | IM43 |
| Etched Bronze..... | IM44 |
| Fired Titanium..... | IM46 |
| Chrome..... | IM49 |
| Dark Annealed..... | IM50 |
| Karat..... | IM54 |
| Red Metal..... | IM55 |
| Oxidized Bronze..... | IM56 |
| Bright Ray..... | IM57 |
| Bismuth Crystal | IM58 |
| Gallium Blue..... | IM59 |

Dashing -100% Post-Consumer Recycled Polyester

| | |
|----------------------|-------------|
| Classic Silver..... | DS21 |
| Refined Marble..... | DS22 |
| Antique Sage..... | DS23 |
| Polished Slate | DS24 |
| Genteel Beige | DS25 |
| Bespoke Tan | DS26 |
| Dapper Grey..... | DS27 |

Quadrille - 52.5% Polyester / 47.5% Recycled Polyester
*Maximum panel width is 48'

| | |
|------------------|-------------|
| Escapade..... | QU30 |
| Shenanigan | QU31 |
| Revelry | QU32 |
| Spring | QU33 |
| Regalia | QU34 |
| Soiree..... | QU35 |
| Zest..... | QU36 |
| Gambol..... | QU37 |
| Fair | QU39 |
| Fiesta..... | QU40 |
| Carnival | QU41 |
| Opus | QU43 |
| Jubilee..... | QU44 |
| Masquerade..... | QU45 |
| Cabarets..... | QU46 |

PET PANEL FABRICS

| | |
|------------------|------------|
| Amethyst..... | GPH |
| Apricot..... | APR |
| Black..... | BLK |
| Blue Smoke | BSK |
| Brick..... | BRI |
| Carnation..... | CNN |
| Denim | DEN |
| Emerald | EMD |
| Graphite..... | GPH |
| Harvest..... | HVT |
| Lapis | LAP |
| Mist | MTS |
| Navy | NVY |
| Pewter | PWT |
| Ruby..... | RBV |
| Shamrock..... | SHR |
| Sunflower | SFR |
| White..... | WHT |



GRADE 1

Dobby - 96% Recycled Polyester / 4% Virgin Polyester

| | |
|-------------------|-------------|
| Snowcap..... | DB30 |
| Bonsai..... | DB31 |
| Cloud..... | DB32 |
| Sand..... | DB33 |
| Pewter..... | DB34 |
| Sante Fe..... | DB35 |
| Corfu..... | DB36 |
| Medium Taupe..... | DB37 |
| Charcoal..... | DB38 |
| Berry..... | DB39 |
| Royal..... | DB40 |
| Titanium..... | DB41 |
| Black..... | DB42 |

Fusion - 90% Virgin Polyester/ 10% Post-Consumer Recycled Polyester

| | |
|----------------|-------------|
| Tangerine..... | FU71 |
| Fresh..... | FU72 |
| Moss..... | FU73 |
| Tomato..... | FU74 |
| Aqua..... | FU75 |
| Sandstone..... | FU76 |
| Granite..... | FU77 |
| Poppy..... | FU78 |
| Cadet..... | FU79 |
| Oasis..... | FU80 |
| Graphite..... | FU81 |
| Viola..... | FU82 |
| Cobalt..... | FU83 |
| Flax..... | FU84 |
| Carbon..... | FU85 |

Illusion - 100% Virgin Polyester

| | |
|-----------------|-------------|
| Cappuccino..... | II01 |
| Paprika..... | II02 |
| Tropic..... | II03 |
| Wicker..... | II04 |
| Hemp..... | II05 |
| Cayenne..... | II06 |
| Maui..... | II07 |
| Dusk..... | II08 |
| Smoke..... | II09 |
| Currant..... | II10 |
| Fiji..... | II11 |
| Ozone..... | II12 |
| Ebony..... | II13 |

Jenny - 100% Polyester

| | |
|--------------------|-------------|
| Midnite..... | JN01 |
| Ebony..... | JN02 |
| Slate..... | JN03 |
| Vermilion..... | JN07 |
| Admiral..... | JN08 |
| Charcoal..... | JN11 |
| Silver Lining..... | JN25 |
| Oatmeal..... | JN26 |
| Sunflower..... | JN27 |
| Cascade..... | JN28 |
| Harvest..... | JN29 |
| Mellon..... | JN30 |
| Berry..... | JN31 |
| Green Grass..... | JN32 |
| Roast..... | JN33 |

Quilt - 100% Polyester

| | |
|--------------------|-------------|
| Black..... | QL10 |
| Charcoal Grey..... | QL11 |
| Navy..... | QL14 |
| Wine..... | QL16 |
| Silver..... | QL19 |
| Feather..... | QL20 |
| Dune..... | QL21 |
| Meadow..... | QL22 |
| Cadet..... | QL23 |
| Geranium..... | QL24 |
| Daisy..... | QL25 |
| Quest..... | QL26 |
| Punch..... | QL27 |
| Tangerine..... | QL28 |
| Cocoa..... | QL29 |

Terrace - 100% Post-Consumer Recycled Polyester

| | |
|---------------------|-------------|
| Lotus..... | TC60 |
| Tigerlily..... | TC61 |
| Shadow..... | TC62 |
| Cobble..... | TC63 |
| Cherry Blossom..... | TC64 |
| Bluebell..... | TC65 |
| Apple..... | TC66 |
| Haze..... | TC67 |
| Cerise..... | TC68 |
| Twilight..... | TC69 |
| Wintergreen..... | TC70 |
| Ironwork..... | TC71 |
| Pine Cone..... | TC72 |
| Flirt..... | TC73 |
| Echo..... | TC74 |

Trak - 100% Recycled Polyester

| | |
|-------------------|-------------|
| Taupe..... | TK40 |
| Mustard..... | TK41 |
| Latte..... | TK42 |
| Cement..... | TK43 |
| Silver..... | TK44 |
| Copper..... | TK45 |
| Teal..... | TK46 |
| Apple..... | TK47 |
| Steel..... | TK48 |
| Merlot..... | TK49 |
| Midnight Sky..... | TK50 |
| Mocha..... | TK51 |
| Carbon..... | TK52 |

Urban - 62% Recycled Polyester / 32% Polyester

| | |
|-------------------|-------------|
| Red Rose..... | UR10 |
| Ocean Blue..... | UR11 |
| Blue Bayou..... | UR12 |
| Green Grass..... | UR13 |
| Sandcastle..... | UR14 |
| Beach Day..... | UR15 |
| Boardwalk..... | UR16 |
| Earth..... | UR17 |
| Brown Ridge..... | UR18 |
| White Sand..... | UR19 |
| Granite Rock..... | UR20 |
| Gravel Road..... | UR21 |
| Black Coal..... | UR22 |

Waterfall - 60% Virgin Polyester /40% Post - Consumer Recycled Polyester

| | |
|------------------|-------------|
| Trance..... | WA40 |
| Tryst..... | WA41 |
| Splash..... | WA42 |
| Victoria..... | WA43 |
| Imagine..... | WA44 |
| Sky..... | WA45 |
| Rainforest..... | WA46 |
| Rumble..... | WA47 |
| Prism..... | WA48 |
| Tranquility..... | WA49 |
| Grand..... | WA50 |
| Rushing..... | WA51 |
| Majestic..... | WA52 |
| Pacific..... | WA53 |
| Dance..... | WA54 |

Waterfall - 60% Virgin Polyester /40% Post - Consumer Recycled Polyester

| | |
|---------------|-------------|
| Lime..... | WV01 |
| Mint..... | WV02 |
| Stone..... | WV03 |
| Flame..... | WV04 |
| Mykonos..... | WV05 |
| Savannah..... | WV06 |
| Mesa..... | WV07 |
| Plasma..... | WV08 |
| Cancun..... | WV09 |
| Quartz..... | WV10 |
| Moonrock..... | WV11 |
| Rubine..... | WV12 |
| Corfu..... | WV13 |
| Bluejay..... | WV14 |

GRADE 2 (FABRIC)

Imprint - 100% Post-Consumer

| | |
|------------------|-------------|
| Polyester..... | IM70 |
| Almond..... | IM71 |
| Cork..... | IM72 |
| Sand..... | IM73 |
| Currie..... | IM74 |
| Candy Apple..... | IM75 |
| Ocean..... | IM76 |
| Navy..... | IM77 |
| Green Tea..... | IM78 |
| Celery..... | IM79 |
| Walnut..... | IM80 |
| Paprika..... | IM81 |
| Graphite..... | IM82 |
| Slate..... | IM83 |
| Licorice..... | IM84 |

GRADE 2 (VINYL)

For availability of chair series in Vinyl, please contact a Global Sales Representative.

Allante FRee - 100% Vinyl Face / 100% Polyester Backing

| | |
|------------------------|-------------|
| Illusion | A01F |
| Bright White | A02F |
| White Crush | A03F |
| Ivory | A04F |
| Ice | A05F |
| Bleached Sand | A06F |
| Taupe Fawn | A07F |
| Warm Smoke | A08F |
| Autumn Rain | A09F |
| Cookie | A10F |
| Sierra Brick | A11F |
| Gibraltar | A12F |
| Chateau Grey | A13F |
| Golden Green | A14F |
| Oasis Green | A15F |
| Ink Black | A16F |
| Purple impulse | A17F |
| Italian Rose | A18F |
| Mountain Sky | A19F |
| Old Navy | A20F |
| Galaxy | A21F |
| Red Truffle | A22F |
| Chocolate Sundae | A23F |
| Province Blue | A24F |
| Eclipse | A25F |

GRADE 3 (RECYCLED)

Couture - 100% Post-Consumer

| | |
|-----------------|-------------|
| Polyester | |
| Mocha | CE71 |
| Sapphire | CE74 |
| Neptune | CE75 |
| Lake | CE76 |
| Willow | CE77 |
| Sassy | CE78 |
| Persimmon | CE80 |
| Carbon | CE81 |
| Sterling | CE82 |



PANEL C.O.M REQUEST FOR APPLICATION TEST

SEND COMPLETED FORM AND FABRIC TO:

Evolve Furniture Group
555 Petrolia Road, Unit 2
Toronto, Ontario M3J2X8
Attn: Nahum Schneider

Requested By: _____

Phone #: _____

Fax #: _____

Project Name _____

Dealer/Specifier _____

Dealer Contact: _____

Evolve CSR: _____

Phone #: _____

Fax #: _____

FABRIC INFORMATION

Fabric Manufacturer: _____

Color Name: _____

Color #: _____

Pattern Name: _____

Pattern #: _____

Content: _____

Weight: _____

Width: _____

Repeat Horizontal: _____

Repeat Vertical: _____

Other Comments: _____

REQUEST FOR APPLICATION TEST (THIS REQUIRES 1 YARDS OF FABRIC)

_____ Evolve Panel

_____ Evolve Tackboard

_____ OH Doors

Total Number of yards for testing: _____

Please Note:

Evolve is not responsible for the duty and brokerage fees for C.O.M. Fabric to clear customs. These charges will be billed to the dealer on a separate invoice.

PANEL FABRIC SPECIFICATION SHEET

SEND COMPLETED FORM TO:

EVOLVE Furniture Group
 555 Petrolia Road, Unit 2
 Toronto, Ontario M3J2X8
 Attn: Nahum Schneider

| | | |
|--|---|---------------------------------------|
| SUPPLIER PATTERN WIDTH CONTENT | REMARKS: _____ _____ _____ _____ | |
| LIGHT FASTNESS FLAMMABILITY TUNNER TEST | REMARKS: _____ _____ _____ _____ | |
| CUT PRICE 1 - 3 ROLLS 4 ROLLS | REMARKS: _____ _____ _____ _____ | |
| DIRECTIONAL PANELS CORNERS RACEWAY COVER RACEWAY CORNERS STRETCH | REMARKS: _____ _____ _____ _____ | EASY HARD X-HARD |
| APPROVED <input type="checkbox"/> NOT APPROVED <input type="checkbox"/> CONDITIONAL APPROVAL <input type="checkbox"/> | | |
| REMARKS: _____ _____ _____ | | |
| * This fabric is approved for upholster-ability only. The approval does not account for the durability of the fabric at the time of, and after installation of the product | | |
| SIGNATURE: _____ PRINT NAME: _____ DATE: _____ | | |



C.O.M AUTHORIZATION FORM FOR EVOLVE PEDESTAL AND LATERAL CUSHIONS

CUSTOMER INFORMATION

To be completed by the dealer/design firm. Use one form per textile. Incomplete information may delay or prevent approval.

| | | |
|--------------------------|-------------------------------------|----------------------------|
| A+D/Dealer/Company Name: | Contact: | Date: |
| Billing Address: | Phone: | |
| City: State: Zip: | Fax: | |
| End-User/Project Name: | End-User/Project Registered? YES NO | If YES, The Evolve Quote#: |

TEXTILE APPLICATION INFORMATION

| MODEL NUMBER | QUANTITY | SPECIAL INSTRUCTIONS |
|---|-------------------------------------|----------------------|
| | | |
| | | |
| | | |
| | | |
| | | |
| Textile Name (Series/Style #): | | |
| Textile Color Name and Description: | | |
| Country of Origin: | | |
| Mill or Manufacturer's Name: | | |
| Textile Content (% Cotton, % Poly, % Wool, etc.): | | |
| Textile Width: | Pattern Repeat: VERTICAL HORIZONTAL | Rail Roaded? YES NO |

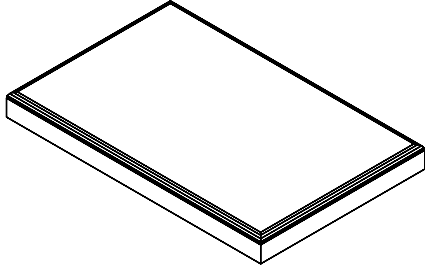
| TEXTILE DIRECTION | NEW TEXTILE | PREVIOUSLY APPROVED TEXTILE |
|---|---|-------------------------------------|
|  <p>STAPLE FABRIC TO THIS FORM IN THE DIRECTION IN WHICH THE FABRIC IS TO BE UPHOLSTERED WITH THE LEFT SIDE OF THIS PAGE BEING THE SAME LEFT AS THE CUSHION.</p> | Attached textile sample (Minimum 5" x 5" Max 12" x 12") In correct DIRECTION and SIDE. | Fax completed form to: 856.596.5684 |
| | MAIL FORM AND TEXTILE SAMPLE ONLY TO: GLOBAL - COM Department 17 West Stow Road Marlton, NJ 08053 856.596.3390 | |
| | Please contact your local EVOLVE CustomeCare representative for status of all COM requests. When textile is approved and an authorization number issued, a set of shipping instructions will be faxed or e-mailed to you. | |
| | Approved textiles are to be shipped to the address that will be included with instructions. Do not ship textiles to the address on this form. Dealer is responsible for the shipping expenses. Brokerage fees will be paid for by Global. However, duties imposed by North American Governments related to textile materials, content and Country of Origin, additional fees may apply and will be billed separately. | |
| Please Note: C.O.M Textiles may not be shipped without shipping documents. GLOBAL is not responsible for any material shipped without the authorization number. | | |
| Please be advised that Global has phased out the use of textiles that contain certain Phthalates, including but not limited to: DEHP (di (2-ethylhexyl) phthalate), DBP (di-n-butyl phthalate), BBP (butyl benzyl phthalate) and DINP (di-isononyl phthalate) (collectively the "Listed Chemicals"). The Listed Chemicals are used in certain types of vinyls. Global cannot accept orders for textiles that contain the Listed Chemicals, if such orders are to be shipped to the U.S.A. or are intended for customer in the U.S.A. If you are not sure if the C.O.M you have selected contains the Listed Chemicals, please contact the manufacturer or supplier of the fabric to verify. | | |

EVOLVE AUTHORIZATION FORM (TO BE COMPLETED BY CUSTOMERCARE REP.)

| | | |
|------------------|---|-------------|
| CAN#: | TEXTILE YARDAGE (REQUIRED FOR THE ORDER): | GU CODE: |
| SIGNATURE: _____ | PRINT NAME: _____ | DATE: _____ |

TOP

**STAPLE
MINIMUM 6" X 6"
FABRIC SAMPLE HERE
IN THE DIRECTION IT IS TO BE
APPLIED TO THE PRODUCT**

BOTTOM



APPENDIX

The Evolve Furniture Group has partnered with the software vendors listed below to provide you with an online source for viewing the 2019 Evolve Electronic Catalog. Please visit their websites for additional information and download details.

2020 Technologies

www.2020technologies.com
5503 Mile Road NW
Grand Rapids, MI 49544
Phone: 800-638-6002

Ice Edge Business Solutions

www.ice-edge.com
4001 S 700 East, Suite 450
Salt Lake City, UT 84107
Phone: 801-747-0373

KISP

www.kisp.com
Customer Support: 416-499-2457
Cad Services Team: 416-499-2457 x3
Customer Service e-mail: tellmemore@kisp.com
CAD Services requests CadServices@kispstech.com

Project Matrix

www.projectmatrix.com
11655 Lebanon Rd.
Cincinnati, OH 45241
Tech Support Instant Messenger: projectmatrixtech@yahoo.com
Phone: 513.554.1665
Fax: 513.554.1255

Quintero-Smith Incorporated/Midnight Oil

www.midnight-oil.com
10469 Kinnard Avenue
Los Angeles, CA 90024
voice: 800-350-7434 (US Only)
international: 310-478-5140
fax: 310-478-4572
e-mail: jimsr@q-si.com



TERMS & CONDITIONS

APPLICATION OF STANDARD TERMS

Sales of Evolve products are made only on Evolve standard terms and conditions of sale which are contained in the Price Book and in Evolve's order acknowledgments. These standard terms and conditions may be modified or supplemented only by a separately written document signed by Evolve's authorized personnel at its head office in Marlton, New Jersey. An offer by Purchaser of said terms and conditions shall not be binding until accepted by Evolve in writing.

All illustrations, specifications and prices in this Price List are based on the latest product information available at the time of publication. Evolve reserves the right to make changes, at any time and without prior notice, to prices, colors, materials, specifications and models offered.

PRICES AND PAYMENT

The prices shown in this Price List, as well as those quoted by Evolve, shall be in US dollars for orders shipped to destinations within the continental United States.

Prices listed herein are for standard product. Quotations for special product are available through Evolve Customer Support Department in Marlton, New Jersey.

If shipping date requested is more than 90 days from date of order Evolve shall use published list prices effective at the time of shipment.

Not included in the list price are special or export packing, unpacking and installation. Orders are invoiced at the time of shipment. The Customer agrees to pay a charge of 2% per month of invoices outstanding more than 30 days.

FOR PAYMENTS ONLY, MAIL TO:

Evolve Furniture Group, a division of:
Global Industries, Inc.
17 West Stow Road
P.O. Box 562
Marlton, New Jersey 08053

Any products sold shall remain the property of Evolve until fully paid for in cash. The Purchaser agrees to perform all acts which may be necessary to perfect and assure retention of title to such products to Evolve until such time as the goods have been paid for in full.

Free freight applies to orders dock delivered to one commercial business location in the contiguous United States during normal business hours. Residential deliveries will incur additional delivery charges.

Please note exception below:

All showroom and mock-up orders will be subject to actual freight charges.

Evolve shall, in its sole discretion, determine the most appropriate method of shipment routing and carrier. Shipments of less than a full trailer load (LTL) shall ship via common carrier. **These LTL shipments are not subject to specific delivery days or times.** Full trailer loads will provide for dedicated delivery time and schedule. Purchaser may request special packaging or method of shipment at Purchaser's sole expense.

TAXES

All sales, use, excise and other applicable taxes and the collection and reporting thereof (excluding only taxes on the net income of Evolve) are the Purchaser's responsibility and will be invoiced to the Purchaser. If Purchaser claims an exemption from such taxes, it shall be the Purchaser's responsibility to furnish an appropriate exemption certificate to Evolve.

ORDER INFORMATION

Evolve requires that **all orders be submitted in writing** to avoid errors and/or duplication. Orders will be acknowledged with Evolve's acknowledgement forms governing the transaction. The details appearing on the acknowledgement will describe the items to be shipped to Purchaser who must ascertain that they are correct. If not correct, Purchaser should notify Evolve immediately by telephone or fax followed by written confirmation. Acknowledgment shows approximate shipping date of items ordered. **Shipping dates are assigned to orders based on the item having the longest manufacturing lead time.** Orders with Customer's Own Material (C.O.M.), or missing or incorrect information (finish selections, fabric selections, etc.) will be scheduled for manufacturing upon receipt of COM or correct complete information. Purchaser must indicate if multiple shipping schedules are required including noting if the shipping date requested is longer than standard posted lead time. Each shipment will be invoiced at time of shipping and will be subject to payment terms described herein.

C.O.M. CUSTOMER'S OWN MATERIAL

Should Purchaser request a fabric, not standard to the Evolve upholstery line, Purchaser shall submit a sample of not less than two yards for approval. Evolve will determine whether fabric is suitable to manufacturing process and applicable UL or code requirements. Should Evolve be required to test such fabric, it shall so advise Purchaser, and Purchaser shall be responsible for all costs associated therewith. This includes all duty and brokerage fees.

Fabric yardage requirement will be determined by Evolve. An additional charge may be made to cover the cost of cutting, matching or sewing unusual or directional patterns. Evolve shall have no responsibility for condition, quality, performance, physical properties or any other aspect of C.O.M. For panels, price as if grade 1 fabric is used.

Evolve reserves the right to reject any C.O.M. deemed unsuitable.

Evolve reserves the right to cancel an order at any time if C.O.M. is, in the sole judgement of Evolve, inadequate for any reason.

CHANGES AND CANCELLATION

The order may not be changed or cancelled by Purchaser without the written consent of Evolve. This charge can be as much as 100% based upon proximity to scheduled shipment date. Special order items and fabric-covered items already in production are not subject to change or cancellation under any circumstances. Fabric-covered items are considered to be in production once the fabric has been cut.

DEPOSIT ON SPECIAL ORDERS

Orders for nonstandard products may, at Evolve's discretion, require deposit prior to scheduling of production, the amount of the deposit being credited against the total price of the project.

SUSPENSION

In the event that the Purchaser defaults in the payment of any sum due Evolve, or in the event the Purchaser's financial condition becomes unsatisfactory to Evolve, Evolve shall have the right at its option, upon written notice to the Purchaser, to cancel shipment of any goods, unless within ten (10) days of Purchaser's receipt of such notice Purchaser provides assurance of payment to Evolve in such form, content and/or amounts as Evolve, in its sole discretion, deems adequate.

COMBINED SHIPMENTS

Evolve will make every effort to combine shipments and orders on written request. However, acceptance of such request shall be with Evolve's sole discretion.

CODE RESTRICTIONS

Evolve portable furniture may be subject to local fire, electrical and/or building codes applicable to portable furniture. It shall be Purchaser's sole responsibility for the proper application of Evolve items within the limitations of such local codes, which may be different from area to area.

SERVICE

Service problems shall be handled by the authorized Evolve dealer. Where this cannot be accomplished on a local level, service problems should be referred to:

Evolve Furniture Group
Customer Support
17 West Stow Road
Marlton, New Jersey USA 08053
856-552-4000 888-827-2500
Attention: Evolve Operations Manager



TERMS & CONDITIONS

STORAGE

In the event Purchaser requests postponement of delivery beyond the acknowledged shipping date, Evolve may transfer the goods to storage on Purchaser's account and at Purchaser's risk and expense subject to a daily storage rate. Such transfer to storage shall be deemed shipment to Purchaser for all purposes, including invoicing and payment.

DELAYS

Evolve's order acknowledgement will state a shipping date which is Evolve's best estimate at the time the order is acknowledged. However, Evolve shall not incur any obligation or liability to Purchaser for failure to ship by a specified date. In addition, Evolve shall not be liable for any loss or damage resulting from any delay or failure in shipment or other failure to perform all or any part of the agreement between the parties with respect to the goods shown on the face of the order acknowledgement where such delay, failure, loss or damage is the proximate result of any act of any governmental authority or political subdivision thereof, revolution, riot, civil disorder or disturbance, act of enemies, delay or default in transportation, strike disputes among or between unions or other labor disputes, delay or inability in obtaining materials and facilities, fire, flood, act of God or any cause not within the reasonable control of Evolve, whether of the class of causes enumerated or otherwise. Without limiting the generality of the foregoing, Evolve may, without causing any breach or incurring liability, allocate goods which are in short supply, regardless of the reasons therefore, among purchasers, in any manner which Evolve, in its sole discretion, deems advisable.

BACK CHARGES

Evolve will not accept charges for expense incurred by the Purchaser in expediting shipments or otherwise. Evolve will not accept charges for the repair of damage by others.

CLAIMS

All goods are sold F.O.B. Toronto, Canada, unless otherwise agreed to in writing by Evolve. Evolve is not responsible for damage which occurs in transit or in storage. The carrier signs for all goods received in good order. It is the Purchaser's responsibility to examine goods upon receipt and to file any claims with the carrier. Any claims made against Evolve for apparent defects, errors or shortages must be made by the Purchaser in writing, within fifteen (15) working days after any delivery. Failure by the Purchaser to make any claim against Evolve within the above-described fifteen days shall constitute acceptance of the goods and a waiver of any apparent defects, errors or shortages.

RETURNS

No returns of goods will be accepted without written consent and shipping instructions, including Evolve's Return Goods Authorization (R.G.A.) numbers, to Evolve. A minimum restocking charge of 35% is made on all authorized returns for credit or refund, provided goods are received by Evolve in the condition in which they left the factory. No credit will be given if goods cannot be reused. Special order items and fabric-covered items are in no event subject to return. All returns must be approved and authorized in writing by Evolve Customer Support, Marlton, New Jersey.

LIFETIME WARRANTY

Evolve warrants that all commercial products are free from defects in material and workmanship, for the life of the product, to the original purchaser. This warranty is made by Evolve only to original customers acquiring the product directly from Evolve's authorized dealers. The customer's sole remedy pursuant to this warranty is limited to repair or replacement of parts or product at Evolve's option. Consent from Evolve must be obtained before any warranty work is performed. This warranty shall not apply to any products which must be replaced because of normal wear and tear, negligence, abuse or "accident", shipping damage, or product use and installation other than in accordance with written instructions or warnings. It shall also not apply when product has been modified or altered, repaired or refurbished by someone other than Evolve or an authorized dealer or because of natural variations over which Evolve has no control. In the event of repair and/or replacement of any defective product, Evolve does not warrant matching color, grain, texture or dye lots. Evolve's warranty does not cover the cost of transportation or labor. Repair or replacement will be at Evolve's option. Evolve makes no warranty that any of its products are suitable for any particular purpose and makes no other warranties, expressed or implied, other than those set forth in this Price List. As codes and standards vary from one jurisdiction to another, references to compliance are solely for convenience and without any representation as to accuracy or suitability. Users must verify the suitability of such information or product for their specific application. In no event shall Evolve be liable in either tort or contract for any loss or direct, special, incidental, consequential, or exemplary damages.

This Lifetime Warranty is NOT applicable to customers who use Evolve products for rental purposes and is effective only for products, parts or components manufactured after January 1, 2011.

Exceptions to this warranty include:

- Global fabrics and wood veneers, which are warranted for five years from date of delivery.
- Electrical components, which are warranted for ten years from the date of delivery.
- Moving parts such as glides, slides, casters, user-adjustable worksurface mechanisms, which are warranted for five years from date of delivery.

- Fading on fabric and wood veneers can be caused by exposure to U.V. rays/sunlight. Natural wood veneer, being a natural material, will have shade differences between veneer sheers, the difference will be more apparent between dye lots.

Evolve does not warrant color fastness on Customer's Own Material.

Because of natural variations over which Evolve has no control, this warranty does not extend to color, grain or texture of wood, and Evolve does not warrant matching of color, grain or texture.

Evolve makes no warranties, including implied warranties of merchantability and fitness for a particular purpose, other than the express warranties contained herein.

LIMITATION OF REMEDY

Purchaser's sole and exclusive remedy (excluding the repair or replacement of goods for breach of the express warranty above) for any matter or claim arising under or relating to these terms and conditions, the goods covered hereby and any transaction involving or relating to such goods, whether in contract, tort (including negligence) or otherwise, shall be payment of the lesser of the cost to repair or replace said product or the purchase price for the goods to which the claim relates. In no event shall Evolve be liable for any special, indirect, consequential, or incidental damages, including without limitation, damages for loss of business profits, business interruptions, or loss of information.

EVOLVE'S WARRANTY DOES NOT APPLY (FOR ANY PRODUCT CATEGORY) TO THE FOLLOWING:

- Failures due to wear and tear
- Failures which result from negligence, abuse, accident or misuse
- Failure to apply, install or maintain products according to Evolve's written instructions and warnings
- Modifications, attachments or repair methods not approved by Evolve
- Damage caused by a carrier in transit, or delivery/installation contractors
- The matching of colors, grains or textures (wood, leather, etc.) of natural materials and color matching of textiles
- Products exposed to extreme hot or cold temperatures or excessively dry or humid environments
- Colorfastness or the matching of color of textiles
- Damage by markings or staining; damage by sharp objects or imprinting from instruments
- Damage to textiles or laminate and wood surfaces/edges from exposure to sunlight (including UV rays)
- Products used for rental purposes

Evolve's warranty applies to products sold within the United States of America, Mexico, the Commonwealth of Puerto Rico and Canada.

showrooms and distribution centers throughout the united states

SHOWROOMS

Atlanta
10 10th Street
Suite 150
Atlanta, GA 30309
T 404.879.0998

Chicago
The Merchandise Mart
10th Floor, Suite 1035
Chicago, IL 60654
T 312.755.0843

Miami
112 NE 41st Street
6th floor
Miami, FL 33137

New York City
386 Park Avenue South,
7th floor
New York, NY 10016
T 212.545.9900

Phoenix
4675 East Cotton
Center Boulevard,
Suite 165
Phoenix, AZ 85040
T 602.426.0666

Boston
One Harbor Street,
Suite 104
Boston, MA 02210
T 617.406.5435

Irvine
18400 Von Karman Ave.
Suite 100
Irvine, CA 92618

New Jersey (Southern)
119 Greentree Road
Marlton, NJ 08053
T 856.596.3390

Philadelphia
1735 Market Street
38th Floor
Philadelphia PA, 19103
215.861.0963

Washington, DC
1130 Connecticut
Avenue
Washington, DC 20036
T 202.659.0230

SHOWROOMS + DISTRIBUTION CENTERS

Atlanta Area
6715 Maple Ave.
Suite 100
Buford, GA 30518
T 678.602.4130

Cincinnati Area
8712 LeSaint Drive
Fairfield, OH 45014
T 513.777.0009

Ft. Lauderdale Area
560 Sawgrass
Corporate Parkway
Sunrise, FL 33325
T 954.846.8888

Los Angeles Area
12320 Bloomfield
Avenue, Unit A
Santa Fe Springs, CA
90670
T 562.484.9686

Baltimore Area
Troy Hill Corporate
Center
7030 Troy Hill Drive
Elkridge, MD 21075
T 410.379.8021

Dallas Area
2025 W. Beltline Rd.,
#100
Carrollton, TX 75006
T 972.236.1366

Houston
7865 Northcourt Road,
Building D, Suite 200
Houston, TX 77040
T 713.695.5777

Seattle Area
Oakesdale Commerce
Center
820 Southwest 34th St.
Building W7, Suite A
Renton, WA 98057
T 425.291.9282

Chicago Area
27W501 North Avenue
West Chicago, IL 60185
T 630.681.2818

Denver Area
16401 E. 33rd Dr., Ste. 50
Aurora, CO 80011
T 303.340.1617

Kansas Area
11617 West 81st Street
Lenexa, KS 66214
T 913.310.9963

Tampa Area
10351 Windhorst Road
Tampa, FL 33619
T 813.621.6272

Global - USA Headquarters

17 West Stow Road P.O. Box 562
Marlton, New Jersey U.S.A. 08053
Tel (856) 596-3390 | (800) 220-1900
www.globalfurnituregroup.com

Global - Canada Headquarters

1350 Flint Road
Downsview, ON Canada M3J 2J7
Sales & Marketing: Tel (1-877) 446-2251
Customer Service: Fax (800) 361-3182
Government Customer Service: Fax (416) 739-6319



Association of Canadian Ergonomists
Association Canadienne d'Ergonomie

